

# Feet / Podstawy

## Table legs

769	Square legs
771	60 legs
776	Table legs
776	Table accessories

## Canapé bed

779	Canapé bed
-----	------------

## Feet

785	Bone feet
786	Smartfeet feet
786	Alumix feet

## Castors

789	Decorative castors
797	Functional castors

## Levellers

800	Adjust interior and exterior
-----	------------------------------

## Sliders

806	Slides
808	Adhesives felts

## Nogi stolowe

769	Nogi kwadratowe
771	Nogi 60
776	Nogi stołowe
776	Akcesoria stołowe

## Kanapkowego

779	Kanapkowego
-----	-------------

## Nóżki

785	Nóżki Bone
786	Nóżki Smartfeet
786	Nóżki Alumix

## Kółka

789	Kółka ozdobne
797	Funkcjonalne kółka

## Poziomice

800	Regulacja wewnętrzna lub zewnętrzna
-----	-------------------------------------

## Podkładki filcowe

806	Podkładki filcowe
808	Samoprzylepne podkładki filcowe

## Square legs Kwadratowe nogi

Discover the models of square table legs that can be combined with all types of kitchen, home and office furniture. You can combine these legs with the tabletop of your choice to create made-to-measure tables and solutions that adapt to the space available.

Odkryj modele kwadratowych nóg stołowych, które można łączyć ze wszystkimi rodzajami mebli kuchennych, domowych i biurowych. Możesz połączyć te nogi z wybranym blatem, aby stworzyć stoły na miarę i rozwiązania, które dostosują się do dostępnej przestrzeni.

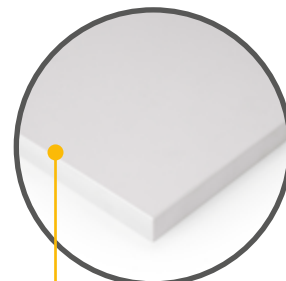
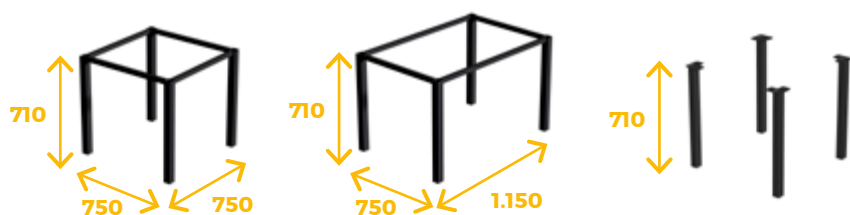

We have particle board tabletops. With an oak or white melamine effect surface. Edged on all four sides with PVC.

Posiadamy blaty z płyty wiórowej. Z dębową lub białą powierzchnią z efektem melaminy. Obrzeża ze wszystkich czterech stron z PVC.



Choose between aluminium, black or white painted steel.

Do wyboru jest aluminium, stal malowana na czarno lub biało.

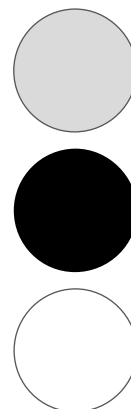

Made of steel.  
Easy screw-on assembly.  
With plastic end caps.  
Screws included.

Wykonany ze stali.  
Łatwy montaż za pomocą śrub.  
Z plastikowymi zaślepkami.  
Śruby w zestawie.

Screw-on assembly.  
Montaż przykręcany.

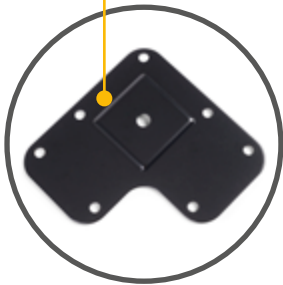

With plastic end caps.  
Z plastikowymi zaślepkami.

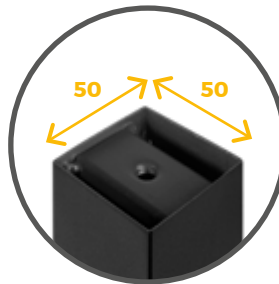

Easy and quick  
to assemble, as  
everything necessary  
for assembly is  
included.

Łatwy i szybki  
montaż, ponieważ  
wszystko, co  
niezbędne do  
montażu, znajduje się  
w zestawie.





**Patas cuadradas**  
**Patas cuadradas**



Square legs and table frame, 50x50mm  
 Nogi kwadratowe i rama stołu, 50x50mm



900x500mm 7018612  
 1.150x750mm 7018812



900x500mm 7018619  
 1.150x750mm 7018819

Width/Szerokość	Finishing/Wykończenie	Packaging/Opakowanie	Cod.
750x750	White painted/Malowane na biało	1 KIT/Zestaw	2047112
1.150x750	White painted/Malowane na biało	1 KIT/Zestaw	2047212
750x750	Black painted/Malowane na czarno	1 KIT/Zestaw	2047114
1.150x750	Black painted/Malowane na czarno	1 KIT/Zestaw	2047214

Steel/Stal

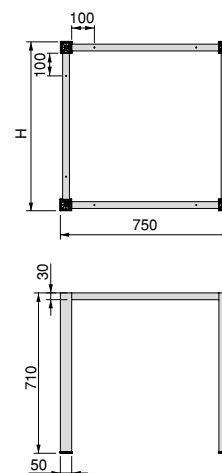

Square legs for table, 50x50mm  
 Nogi stołowe kwadratowe, 50x50mm

Finishing/Wykończenie	Packaging/Opakowanie	N° pieces/Liczba elementów	Cod.
Black painted/Malowane na czarno	1 LOT/Partia	4 units/4 sztuk	2047014
White painted/Malowane na biało	1 LOT/Partia	4 units/4 sztuk	2047012
Silver painted/Malowane aluminium	1 LOT/Partia	4 units/4 sztuk	2047025

Steel/Stal

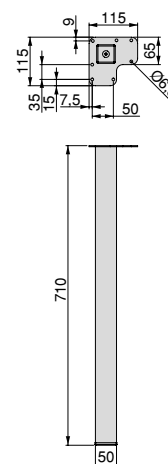



## Legs 60 Nogi 60

Made of steel.  
Easy screw-on assembly.  
Height adjustable.  
Screws included.

Wykonany ze stali.  
Łatwy montaż za pomocą śrub.  
Regulowana wysokość.  
Śruby w zestawie.



Ø60

RECOMMENDED  
WEIGHT  
50kg



Chrome plated/Chromowane



White painted/Malowane na biało



Black painted/Malowane na czarno



Silver painted/Malowane aluminium



Satin finished nickel/Nikiel satynowy



Conus table leg, D. 60 mm, Steel  
Nogi stołowe, średnica 60 mm, stal, Conus

Finishing/Wykończenie	Packaging/Opakowanie	Cod.
Silver painted/Malowane aluminium	1 Unit/Szt	3068925

Plastic, Steel/Plastik, Stal

Ø60

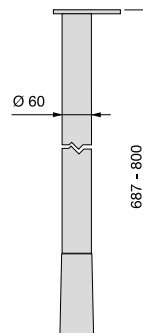
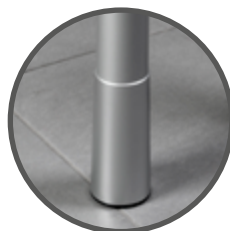

D. 60 mm Table legs in steel  
Nogi stołu D. 60 mm ze stali



900x500mm 7018612  
1.150x750mm 7018812



900x500mm 7018619  
1.150x750mm 7018819



Diametre/Średnica	H	Finishing/Wykończenie	Packaging/Opakowanie	Cod.
60	870	Chrome plated/Chromowane	1 UN/UN	3048011
60	870	Black painted/Malowane na czarno	1 UN/UN	3048014
60	870	Silver painted/Malowane aluminium	1 UN/UN	3048025
60	738	Silver painted/Malowane aluminium	1 UN/UN	3047725
60	870	Satin finished nickel/Nikiel satynowy	1 UN/UN	3048051

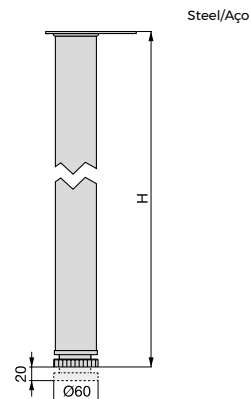
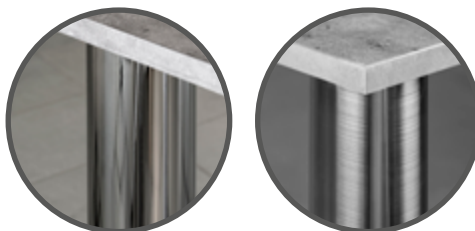

D. 60 mm Table legs in steel  
Nogi stołu D. 60 mm ze stali



Diametre/Średnica	H	Finishing/Wykończenie	Packaging/Opakowanie	N° pieces/Liczba elementów	Cod.
60	710	Chrome plated/Chromowane	1 LOT/Partia	4 units/4 sztuk	2034511
60	830	Chrome plated/Chromowane	1 LOT/Partia	4 units/4 sztuk	2034211
60	710	White painted/Malowane na biało	1 LOT/Partia	4 units/4 sztuk	2034512
60	710	Black painted/Malowane na czarno	1 LOT/Partia	4 units/4 sztuk	2034514
60	710	Silver painted/Malowane aluminium	1 LOT/Partia	4 units/4 sztuk	2034525
60	830	Silver painted/Malowane aluminium	1 LOT/Partia	4 units/4 sztuk	2034225
60	710	Satin finished nickel/Nikiel satynowy	1 LOT/Partia	4 units/4 sztuk	2034551
60	830	Satin finished nickel/Nikiel satynowy	1 LOT/Partia	4 units/4 sztuk	2034251

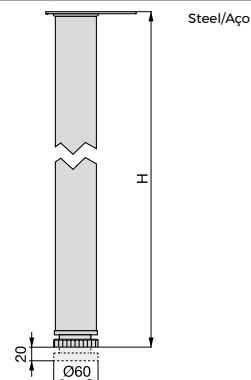
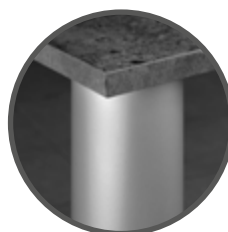

## Table legs Nogi stołu

Discover the models of table legs designed to create original table designs. You can combine these legs with the tabletop of your choice to create made-to-measure tables and solutions that adapt to the space available.

Odkryj modele nóg stołowych zaprojektowanych do tworzenia oryginalnych projektów stołów. Możesz połączyć te nogi z wybranym blatem, aby stworzyć stoły na miarę i rozwiązania, które dostosują się do dostępnej przestrzeni.

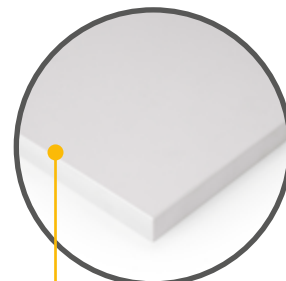
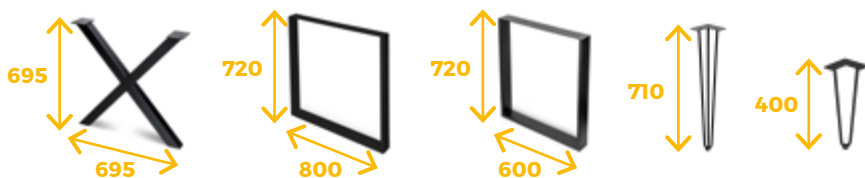

We have particle board tabletops. With oak or white melamine effect surface. Edged on all four sides with PVC.

Posiadamy blaty z płyty wiórowej. Z dębową lub białą melaminową powierzchnią z efektem melaminy. Obrzeża ze wszystkich czterech stron z PVC.



Choose between black or white painted steel.

Do wyboru stal malowana na czarno lub biało.

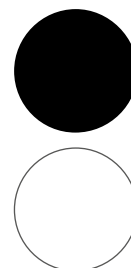



Made of steel.  
 Painted in black or white.  
 Easy screwed assembly.  
 Stops to avoid marks.  
 Screws included.

Wykonane ze stali.  
 Malowana na czarno lub biało.  
 Łatwy montaż za pomocą śrub.  
 Ograniczniki zapobiegające odciskom.  
 Śruby w zestawie.



Screw-on assembly.  
 Montaż przykręcany.



Bumpers to prevent marking.  
 Zderzaki zapobiegające  
 oznakowaniu.



RECOMMENDED  
**80kg**  
 WEIGHT

RECOMMENDED  
**40kg**  
 WEIGHT

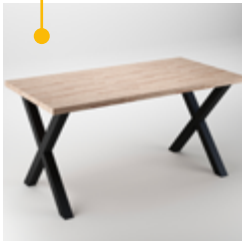

Cross legs for tables  
Nóg stołowych Cross

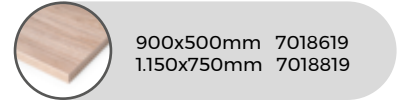
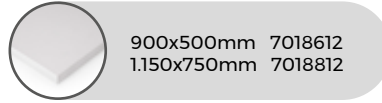

Height/Wysokość	Width/Szerokość	Finishing/Wykończenie	Packaging/Opakowanie	Cod.
695	695	White painted/Malowane na biało	1 Pair/Kpl.	2040212
695	695	Black painted/Malowane na czarno	1 Pair/Kpl.	2040214

Steel/Stal

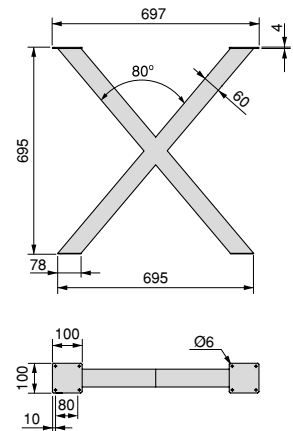

Rectangular Square legs for tables  
Nóg stołowych prostokątnych Square



A	Height/Wysokość	Width/Szerokość	Finishing/Wykończenie	Packaging/Opakowanie	Cod.
600	720	600	White painted/Malowane na biało	1 Pair/Kpl.	2040012
800	720	800	White painted/Malowane na biało	1 Pair/Kpl.	2040112
600	720	600	Black painted/Malowane na czarno	1 Pair/Kpl.	2040014
800	720	800	Black painted/Malowane na czarno	1 Pair/Kpl.	2040114

Steel/Stal

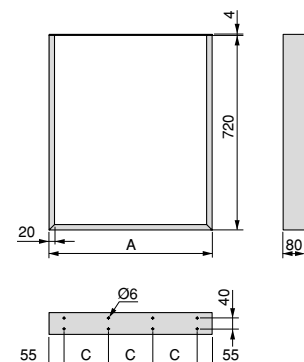
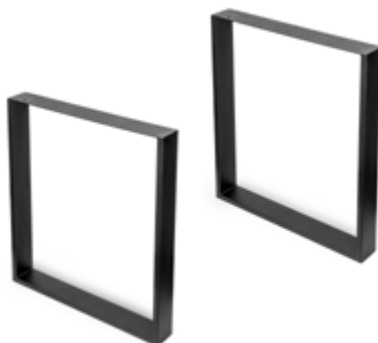

3-rod Hairpin legs for tables  
Nóg stołowych Hairpin z 3 prętów



900x500mm 7018612  
1.150x750mm 7018812



900x500mm 7018619  
1.150x750mm 7018819



Height/Wysokość	Finishing/Wykończenie	Packaging/Opakowanie	N° pieces/Liczba elementów	Cod.
710	White painted/Malowane na biało	1 LOT/Partia	4 units/4 sztuk	2040412
710	Black painted/Malowane na czarno	1 LOT/Partia	4 units/4 sztuk	2040414

Steel/Stal

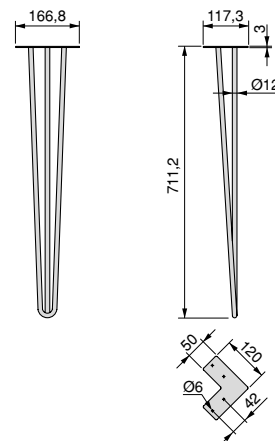

2 rod Hairpin legs for tables  
Nóg stołowych Hairpin z 2 prętów



Height/Wysokość	Finishing/Wykończenie	Packaging/Opakowanie	N° pieces/Liczba elementów	Cod.
400	White painted/Malowane na biało	1 LOT/Partia	4 units/4 sztuk	2040312
400	Black painted/Malowane na czarno	1 LOT/Partia	4 units/4 sztuk	2040314

Steel/Stal

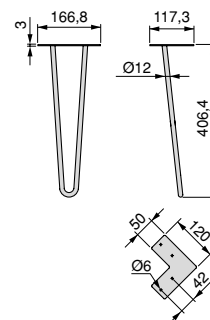

Motorised height-adjustable table  
Biuurko o regulowanej wysokości



Finishing/Wykończenie	Packaging/Opakowanie	Cod.
White painted/Malowane na biało 	1 Unit/Szt	2009112

Steel/Stal

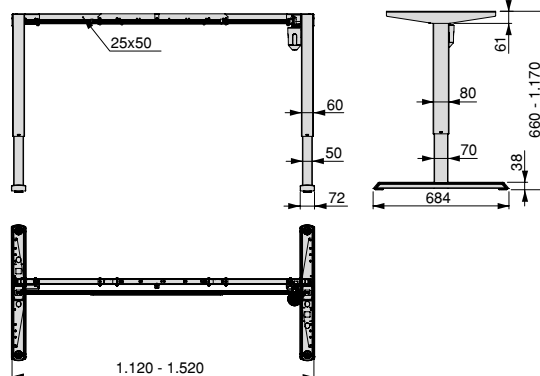





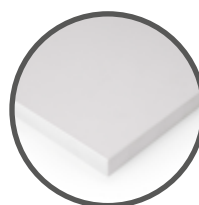

TABLE ACCESSORIES / AKCESORIA STOŁOWE

Table tops or shelf shelves  
Blaty stołowe lub półki

L	P	Thickness/Grubość	Finishing/Wykończenie	Packaging/Opakowanie	Cod.
600	200	30	White painted/Malowane na biało 	1 Unit/Szt	7018712
900	500	30	White painted/Malowane na biało 	1 Unit/Szt	7018612
1150	750	30	White painted/Malowane na biało 	1 Unit/Szt	7018812
600	200	30	Oak effect/Efekt dąb 	1 Unit/Szt	7018719
900	500	30	Oak effect/Efekt dąb 	1 Unit/Szt	7018619
1150	750	30	Oak effect/Efekt dąb 	1 Unit/Szt	7018819

Wood/Drewno



Set of lift-up mechanisms for coffee tables  
Zestaw dwóch podnośników do stolików



Finishing/Wykończenie	Packaging/Opakowanie	Cod.
Black painted/Malowane na czarno	1 Pair/Kpl.	4014414

Steel/Stal

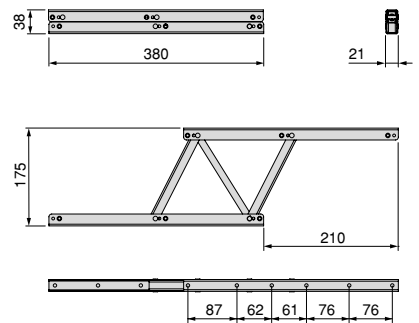



## Canapé bed Kanapkowego

For 90 cm beds.  
With 350 N pistons.  
Side opening.  
Maximum weight 30 kg.  
Easy assembly.

Do łóżek 90 cm.  
Z tłokami 350 N.  
Otwieranie boczne.  
Maksymalna waga 30 kg.  
Łatwy montaż.

90cm

350N

30kg



For 135 cm beds.  
With 1,150 N pistons.  
Front opening.  
Maximum weight 60 kg.  
Easy assembly.

Do łóżek 135 cm.  
Z tłokami 1 150 N.  
Otwieranie z przodu.  
Maksymalna waga 60 kg.  
Łatwy montaż.

135cm

1.150N

60kg

Lift-up mechanism set for side canapé bed  
Zestaw mechanizmu podnoszącego do bocznego łóża kanapkowego



Description/Opis	Finishing/Wykończenie	Packaging/Opakowanie	Cod.
90 cm/90 cm	Black painted/Malowane na czarno 	1 Pair/Kpl.	7090114

Steel/Stal

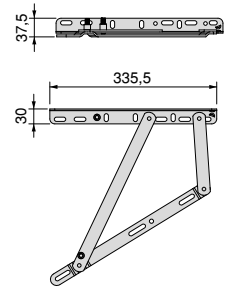

Lift-up mechanism set for front canapé bed  
Zestaw mechanizmu podnoszącego dla przedniego łóża kanapkowego



Description/Opis	Finishing/Wykończenie	Packaging/Opakowanie	Cod.
135 cm/135 cm	Black painted/Malowane na czarno 	1 Pair/Kpl.	7090214

Steel/Stal

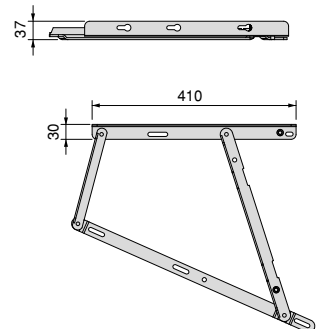

## Feet Nóżki

These feet are height adjustable to correct any unevenness in the floor. They stand out for their high load capacity, supporting a weight of 40 kg in compression. They are compatible with aluminium and wood skirting boards by means of screws or by means of a recess.

Nóżki te mają regulowaną wysokość, co pozwala korygować nierówności podłogi. Wyróżniają się wysoką nośnością, wytrzymując nacisk 40 kg. Są kompatybilne z aluminiowymi i drewnianymi listwami przypodłogowymi za pomocą śrub lub wgłębienia.



Combine the feet with the kitchen skirting boards.

Combine the feet with the kitchen skirting boards.

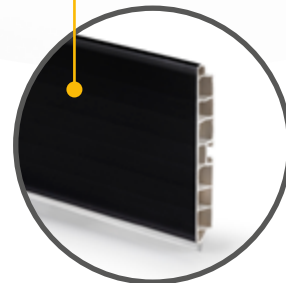

Height adjustable.  
Compatible with plinths.  
Easy to assemble.

Regulowana wysokość.  
Kompatybilny z cokołami.  
Łatwy montaż.

**40kg**

**Ø48**

**KITS**

## Adjustable feet Bone for furniture 60-80

## Regulator wysokości Bone 60-80

Height/Wysokość	H	Finishing/Wykończenie	Packaging/Opakowanie	Cod.
60	56-66	Black plastic/Czarny plastik	200 Unit/Szt	3911317
80	74-84	Black plastic/Czarny plastik	200 Unit/Szt	3911417

Plastic/Plastik

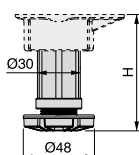

Tested by CATAS with a weight of 100 kg per module in accordance with UNE EN 14749:2005.

Przetestowany przez CATAS przy wadze 100 kg na moduł zgodnie z normą UNE EN 14749:2005.

## Adjustable feet Bone for furniture 100-150

## Regulator wysokości Bone 100-150

Height/Wysokość	H	Finishing/Wykończenie	Packaging/Opakowanie	Cod.
100 - 120	98-140	Black plastic/Czarny plastik	200 Unit/Szt	3911817
120 - 150	118-160	Black plastic/Czarny plastik	200 Unit/Szt	3911917
150 - 165 - 180	148-190	Black plastic/Czarny plastik	200 Unit/Szt	3912017

Plastic/Plastik

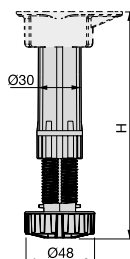

Tested by CATAS with a weight of 100 kg per module in accordance with UNE EN 14749:2005.

Przetestowany przez CATAS przy wadze 100 kg na moduł zgodnie z normą UNE EN 14749:2005.



## Mounting base with screw for Bone Feet

## Podstawka montażowa pod śrubę do nóżek Bone

Finishing/Wykończenie	Packaging/Opakowanie	Cod.
Black plastic/Czarny plastik 	200 Unit/Szt	3912117

Plastic/Plastik

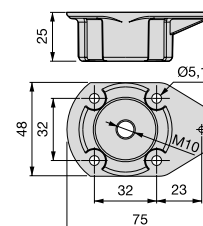

## Direct base mounting for Bone Feet

## Bezpośrednia podstawka montażowa do nóżek Bone

Diametre/Średnica	Drilling diameter/Średnica otworu wierconego	Finishing/Wykończenie	Packaging/Opakowanie	Cod.
12.5	12	Black plastic/Czarny plastik 	200 Unit/Szt	3912217
13.5	13	Black plastic/Czarny plastik 	200 Unit/Szt	3913217
15.5	15	Black plastic/Czarny plastik 	200 Unit/Szt	3913117
16.5	16	Black plastic/Czarny plastik 	200 Unit/Szt	3912417

Plastic/Plastik

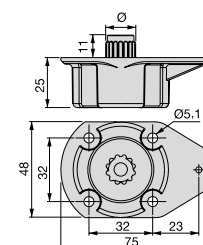



Mounting clip direct-screw for Bone feet

Klipsy cokołu przykręcane/bezpośrednie mocowanie do nóżek Bone

Finishing/Wykończenie	Packaging/Opakowanie	Cod.
Black plastic/Czarny plastik 	200 KIT/Zestaw	3912917

Plastic/Plastik

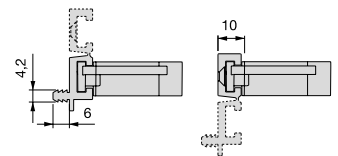
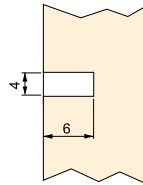

Clip for plinth Noline and Plasline for Bone feet

Klipsy do cokołów Noline i Plasline do nóżek Bone

Finishing/Wykończenie	Packaging/Opakowanie	Cod.
Black plastic/Czarny plastik 	200 Unit/Szt	3913017

Plastic/Plastik

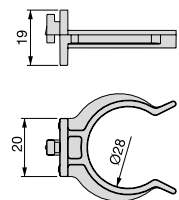

Screw M10 for Bone Feet





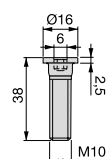

Wkręt M10 do nóżek Bone

Finishing/Wykończenie	Packaging/Opakowanie	Cod.
Zinc plated/Cynkowane 	200 Unit/Szt	3912605

Steel/Stal



Kit levelling feet Bone for furniture with clip for plinth  
 Stopka poziomująca z podstawką Bone z klips do cokołów

Height/Wysokość	Finishing/Wykończenie		Packaging/Opakowanie	Cod.
100	Black plastic/Czarny plastik		10 KIT/Zestaw	2032117
100	Black plastic/Czarny plastik		50 KIT/Zestaw	3999517
120	Black plastic/Czarny plastik		10 KIT/Zestaw	2032217
120	Black plastic/Czarny plastik		50 KIT/Zestaw	3999017
150	Black plastic/Czarny plastik		10 KIT/Zestaw	2032317
150	Black plastic/Czarny plastik		50 KIT/Zestaw	3999417

Plastic, Steel/Plastik, Stal

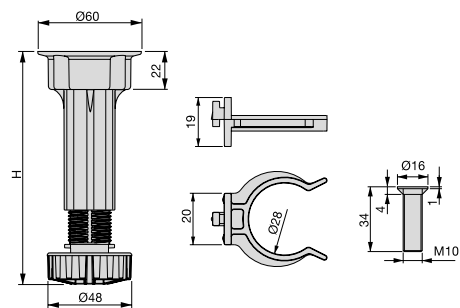



Tested by CATAS with a weight of 100 kg per module in accordance with UNE EN 14749:2005.

Przetestowany przez CATAS przy wadze 100 kg na moduł zgodnie z normą UNE EN 14749:2005.

## Kit levelling feet Bone for furniture with mounting clip direct-screw

Stopka poziomująca z podstawką Bone z klips cokołu przykręcane/bezpośrednie mocowanie

Height/Wysokość	Finishing/Wykończenie		Packaging/Opakowanie	Cod.
100	Black plastic/Czarny plastik		10 KIT/Zestaw	2022417
120	Black plastic/Czarny plastik		10 KIT/Zestaw	2022517
150	Black plastic/Czarny plastik		10 KIT/Zestaw	2022617

Plastic/Plastik

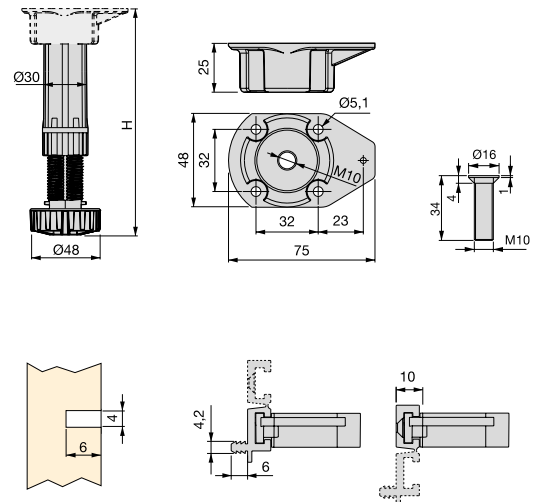



Tested by CATAS with a weight of 100 kg per module in accordance with UNE EN 14749:2005.

Przetestowany przez CATAS przy wadze 100 kg na moduł zgodnie z normą UNE EN 14749:2005.

## Furniture feet Smartfeet 1

## Nóżki do mebli Smartfeet 1



H	Finishing/Wykończenie		Packaging/Opakowanie	Cod.
100 - 110	Chrome plated/Chromowane		20 Unit/Szt	2006011
140 - 150	Chrome plated/Chromowane		16 Unit/Szt	2006111
100 - 110	White painted/Malowane na biało		20 Unit/Szt	2006012
100 - 110	Black painted/Malowane na czarno		20 Unit/Szt	2006014

Plastic/Plastik

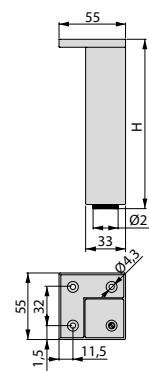





## ALUMIX FEET / NÓŻKI ALUMIX

## Furniture feet Alumix 1

## Nóżki do mebli Alumix 1



H	Finishing/Wykończenie		Packaging/Opakowanie	N° pieces/Liczba elementów	Cod.
80	Silver painted/Malowane aluminium		1 LOT/Partia	20 units/20 jednostki	2042025
100	Chrome plated/Chromowane		1 LOT/Partia	20 units/20 jednostki	2042111
100	Silver painted/Malowane aluminium		1 LOT/Partia	20 units/20 jednostki	2042125
120	Silver painted/Malowane aluminium		1 LOT/Partia	20 units/20 jednostki	2042225

Plastic/Plastik



x20

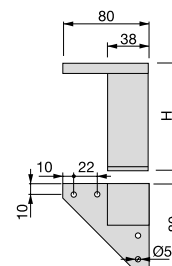
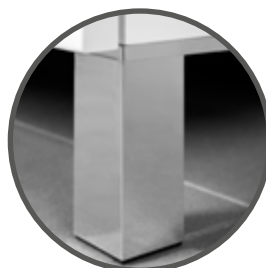

**Alumix 8 foot for furniture**  
**Stopka do mebli Alumix 8**



H	Finishing/Wykończenie	Packaging/Opakowanie	N° pieces/Liczba elementów	Cod.
12	Silver painted/Malowane aluminium	1 LOT/Partia	20 units/20 jednostki	2039425
24	Silver painted/Malowane aluminium	1 LOT/Partia	20 units/20 jednostki	2039525

Plastic/Plastik

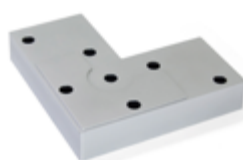

x20

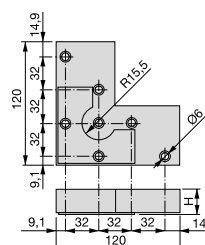

**Alumix 7 foot for furniture**  
**Stopka do mebli Alumix 7**



H	Finishing/Wykończenie	Packaging/Opakowanie	N° pieces/Liczba elementów	Cod.
15	Silver painted/Malowane aluminium	1 LOT/Partia	20 units/20 jednostki	2039325
30	Silver painted/Malowane aluminium	1 LOT/Partia	20 units/20 jednostki	2039125
45	Silver painted/Malowane aluminium	1 LOT/Partia	20 units/20 jednostki	2039225

Plastic/Plastik



x20

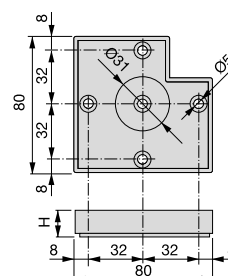
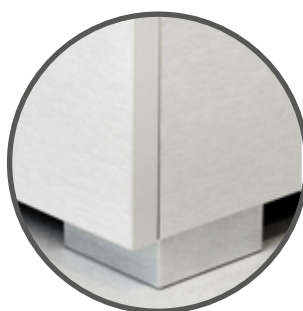



## Castors Kółka

They are perfect for moving your furniture safely. They have a trendy design in home and office furniture. They provide a smooth and silent glide.

Są idealne do bezpiecznego przenoszenia mebli. Mają modny design w meblach domowych i biurowych. Zapewniają płynne i ciche przesuwanie.

### KITS

Made of steel and plastic.  
Load capacity from 30 to 70 kg,  
depending on model.  
Screws included in the kit.

Wykonane ze stali i tworzywa sztucznego.  
Udźwig od 30 do 70 kg, w zależności od  
modelu.  
Śruby w zestawie.

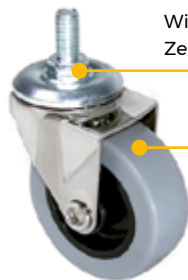

With bolt.  
Ze śrubą.

Without brake.  
Bez hamulca.

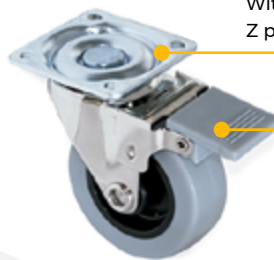

With plate.  
Z płytą.

With brake.  
Z hamulcem.



**Hole 2 castors kit with plate-mounted**  
**Zestaw kółka Hole 2 z płytą montażową**

Diametre/Średnica	Load/Ladunek	CxB	DxE	H	Finishing/Wykończenie	Packaging/Opakowanie	Cod.
60	30 Kg	42x42	32x32	92,5	Black painted/Malowane na czarno 	1 KIT/Zestaw	2041414
60	30 Kg	42x42	32x32	92,5	Grey plastic/Szary plastik 	1 KIT/Zestaw	2041421

Plastic, Steel/Plastik, Stal

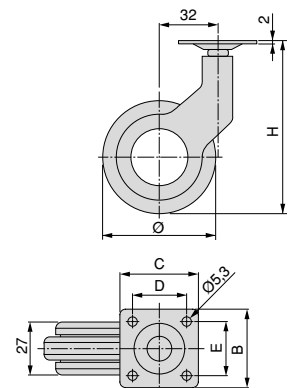
**Hole castors kit with plate-mounted**  
**Zestaw kółka Hole z płytą montażową**

Diametre/Średnica	Load/Ladunek	CxB	DxE	H	Finishing/Wykończenie	Packaging/Opakowanie	Cod.
65	60 Kg	47x47	32x32	84	Black painted/Malowane na czarno 	1 KIT/Zestaw	2041214

Plastic, Steel/Plastik, Stal

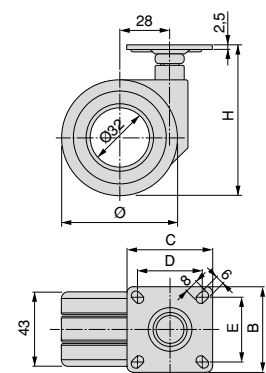



**Castors**  
**Kółka**



**Slip 2 Red castors kit with plate-mounted**  
**Zestaw kółka Slip 2 z płytą montażową**

Diametre/ Średnica	Load/Ladunek	CxB	DxE	H	X	Y	Z	Finishing/Wykończenie	Packaging/ Opakowanie	Cod.
50	50 Kg	46x46	36x36	64	17,5	28,5	Ø4,5	Not defined/ Nieokreślone	<input type="checkbox"/>	1 KIT/Zestaw 2041020
75	70 Kg	60x60	45x45	97	28	33	6,5x8,5	Not defined/ Nieokreślone	<input type="checkbox"/>	1 KIT/Zestaw 2041120

Plastic, Steel/Plastik, Stal

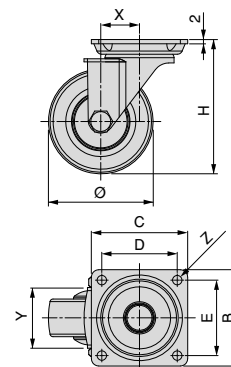
**Bowl 2 castors kit with plate-mounted**  
**Zestaw kółka Bowl 2 z płytą montażową**

Diametre/Średnica	Load/Ladunek	CxB	DxE	H	Finishing/Wykończenie	Packaging/ Opakowanie	Cod.
50	60 Kg	47x47	32,5x32,5	61,5	Not defined/ Nieokreślone	<input type="checkbox"/>	1 KIT/Zestaw 2041320

Plastic, Steel/Plastik, Stal

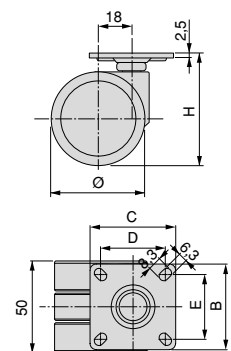

Slip 3 transparent castors kit with plate-mounted  
Zestaw kółka Slip 3 z płytą montażową

Diametre/Srednica	Load/Ladunek	CxB	DxE	H	Finishing/Wykończenie	Packaging/Opakowanie	Cod.
35	40 kg	42x42	36x36	49,5	Not defined/ Nieokreślone	<input type="checkbox"/> 1 KIT/Zestaw	2041520

Plastic, Steel/Plastik, Stal

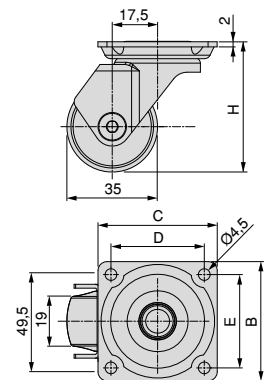

Bowl wheel kit with mounting plate  
Zestaw kółek z płytą mocującą

Diametre/Srednica	Load/Ladunek	Thickness/Grubość	CxB	DxE	H	Z	Finishing/Wykończenie	Packaging/Opakowanie	Cod.
50	50 Kg	5,3	42x42	32x32	73	5,3	Grey plastic/ Szary plastik	<input type="checkbox"/> 1 KIT/Zestaw	2036421

Plastic, Steel/Plastik, Stal

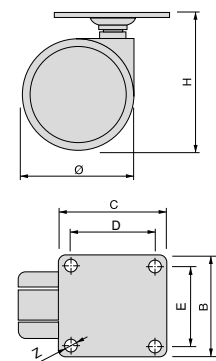

## Slip wheel kit with mounting plate

## Zestaw kółek ślizgowych z płytą mocującą

Diametre/Średnica	Load/Ladunek	CxB	DxE	H	Z	Finishing/Wykończenie	Packaging/Opakowanie	Cod.
50	35 Kg	42x42	32x32	64	4,5	Grey plastic/ Szary plastik	1 KIT/Zestaw	2036221
75	40 Kg	60x60	45x45	96	6,5x8,5	Grey plastic/ Szary plastik	1 KIT/Zestaw	2036321

Plastic, Steel/Plastik, Stal

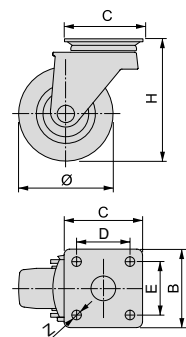

## Slip wheel kit with bolt

## Zestaw kółek ślizgowych mocowanych śrubą

Diametre/Średnica	Load/Ladunek	Model/Model	Finishing/Wykończenie	Packaging/Opakowanie	Cod.
50	30 Kg	8x15/8x15	Grey plastic/Szary plastik	1 KIT/Zestaw	2037121

Plastic, Steel/Plastik, Stal

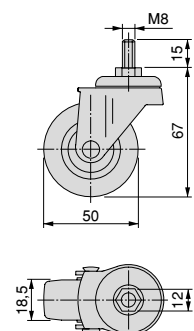

## Slip Transparent wheel kit with mounting plate

Zestaw przezroczystych kółek ślizgowych z płytą mocującą

Diametre/Średnica	Load/Ladunek	CxB	DxE	H	Z	Finishing/Wykończenie	Packaging/Opakowanie	Cod.
50	40 kg	42x42	32x32	63	4,5	Not defined/ Nieokreślone	<input type="checkbox"/> 1 KIT/Zestaw	2036020
75	50 kg	60x60	45x45	98	6,3x8	Not defined/ Nieokreślone	<input type="checkbox"/> 1 KIT/Zestaw	2036120

Plastic, Steel/Plastik, Stal

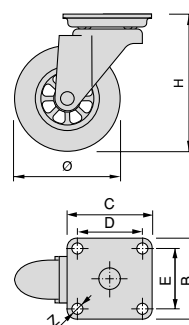

## Mak wheel kit with mounting plate

Zestaw Mak kółek z płytą mocującą

Diametre/Średnica	Load/Ladunek	Finishing/Wykończenie	Packaging/Opakowanie	Cod.
80	50 Kg	Grey plastic/Szary plastik	<input type="checkbox"/> 1 KIT/Zestaw	2037921

Plastic, Steel/Plastik, Stal

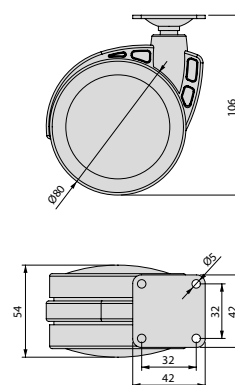

## Black wheel kit with mounting plate

Zestaw czarnych kółek z płytą mocującą

Diametre/Średnica	Load/Ladunek	CxB	DxE	H	Z	Finishing/Wykończenie	Packaging/Opakowanie	Cod.
50	35 kg	50x50	35x35	75	6,5x5,5	Black plastic/ Czarny plastik	1 KIT/Zestaw	2008917
75	35 kg	65x65	45x45	100	6x9	Black plastic/ Czarny plastik	1 KIT/Zestaw	2009017

Plastic, Steel/Plastik, Stal

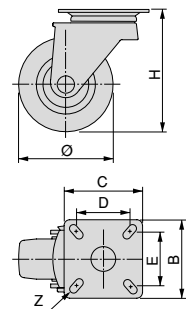

## Slip 2 wheel kit with mounting plate

zestaw kółek ślizgowych 2 z płytą mocującą

Diametre/Średnica	Load/Ladunek	Finishing/Wykończenie	Packaging/Opakowanie	Cod.
100	70 Kg	Grey plastic/Szary plastik	1 KIT/Zestaw	2003021

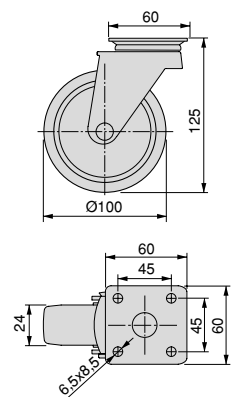

Plastic, Steel/Plastik, Stal





## Bowl wheels with mounting plate

## Zestaw kółek z płytą mocującą Bowl



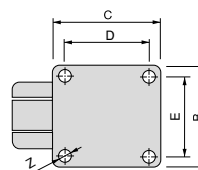
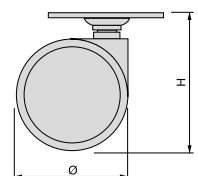

Description/ Opis	Diameter/ Średnica	Load/La- dunek	Thickness/ Grubość	CxB	DxE	H	Z	Finishing/Wykończenie	Packaging/ Opakowanie	Cod.	
without brake/ bez hamulca	50	50 Kg	5,3	42x42	32x32	73	5,3	Grey plastic/ Szary plastik		100 Unit/Szt	3160821
without brake/ bez hamulca	75	50 Kg	5,3	50x50	38x38	97	5	Grey plastic/ Szary plastik		50 Unit/Szt	3160421
with brake/z hamulcem	50	50 Kg	5,3	42x42	32x32	73	5,3	Grey plastic/ Szary plastik		100 Unit/Szt	3160921

Plastic, Steel/Plastik, Stal



## Slip castors grey-black with plate-mounted

## Zestaw czarno-szarych kółek ślizgowych z płytą mocującą

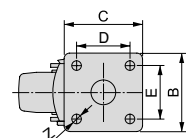
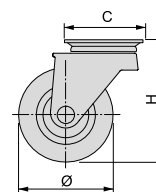

Description/ Opis	Diameter/ Średnica	Load/Ladunek	CxB	DxE	H	Z	Finishing/Wykończenie	Packaging/ Opakowanie	Cod.	
without brake/ bez hamulca	50	35 Kg	42x42	32x32	64	4,5	Grey plastic/ Szary plastik		125 Unit/Szt	2002121
with brake/z hamulcem	50	35Kg	42x42	32x32	64	4,5	Grey plastic/ Szary plastik		100 Unit/Szt	2002221
without brake/ bez hamulca	75	40Kg	60x60	45x45	96	6,5x8,5	Grey plastic/ Szary plastik		95 Unit/Szt	2002321
with brake/z hamulcem	75	40 Kg	60x60	45x45	96	6,5x8,5	Grey plastic/ Szary plastik		90 Unit/Szt	2002421

Plastic, Steel/Plastik, Stal



## Slip Transparent wheels with mounting plate

Zestaw przezroczystych kółek ślizgowych z płytą mocującą

Description/Opis	Diametre/Srednica	Load/Ladunek	CxB	DxE	H	Z	Finishing/Wykończenie	Packaging/Opakowanie	Cod.
without brake/bez hamulca	50	40 Kg	42x42	32x32	63	4,5	Not defined/Nieokreślone	 200 Unit/Szt	3075620
with brake/z hamulcem	50	40 Kg	42x42	32x32	63	4,5	Not defined/Nieokreślone	 200 Unit/Szt	3075720

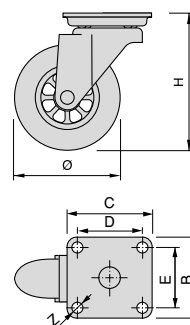

Plastic, Steel/Plastik, Stal



## FUNCTIONAL CASTORS / FUNKCJONALNE KÓŁKA

## Kit of castors for drawer units with plate

Zestaw kółek do szafek z płytą

Description/Opis	Diametre/Średnica	Load/Ladunek	CxB	DxE	H	Z	Finishing/Wykończenie	Packaging/Opakowanie	Cod.
4 without brake/4 bez hamulca	30	15 Kg	30x30	20x20	44	4,5	Black plastic/Czarny plastik	 1 KIT/Zestaw	2036817
2 with brake + 2 without brake/2 z hamulcem+ 2 bez hamulca	40	25 Kg	38x38	25x25	55	5,5	Black plastic/Czarny plastik	 1 KIT/Zestaw	2036717
2 with brake + 2 without brake/2 z hamulcem+ 2 bez hamulca	50	30 Kg	38x38	25x25	65	5,5	Black plastic/Czarny plastik	 1 KIT/Zestaw	2036617

Plastic, Steel/Plastik, Stal

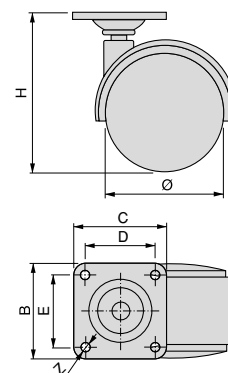

## Kit of castors for drawer units with bolts

## Zestaw zestawów kołowych do szafek z trzpieniem

Description/Opis	Diametre/Srednica	Load/Ladunek	A	H	Finishing/Wykończenie	Packaging/Opakowanie	Cod.
without brake/bez hamulca	40	25 Kg	38	50	Black plastic/ Czarny plastik	1 KIT/Zestaw	2037817

Plastic, Steel/Plastik, Stal

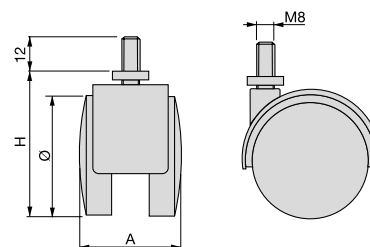

## Castors for drawer units with plate

## Kółka do szafek szufladowych z płytą

Description/Opis	Diametre/Srednica	Load/Ladunek	CxB	DxE	H	Z	Finishing/Wykończenie	Packaging/Opakowanie	Cod.
without brake/bez hamulca	30	15 Kg	30x30	20x20	44	4,5	Black plastic/ Czarny plastik	400 Unit/Szt	3036417
without brake/bez hamulca	40	25 Kg	38x38	25x25	55	5,5	Black plastic/ Czarny plastik	200 Unit/Szt	3036617
without brake/bez hamulca	45	25 Kg	38x38	25x25	59	5,5	Black plastic/ Czarny plastik	200 Unit/Szt	3036717
without brake/bez hamulca	50	30 Kg	38x38	25x25	65	5,5	Black plastic/ Czarny plastik	200 Unit/Szt	3036817
with brake/z hamulcem	40	25 Kg	38x38	25x25	55	5,5	Black plastic/ Czarny plastik	200 Unit/Szt	3037217
with brake/z hamulcem	50	30 Kg	38x38	25x25	65	5,5	Black plastic/ Czarny plastik	200 Unit/Szt	3037417

Plastic, Steel/Plastik, Stal

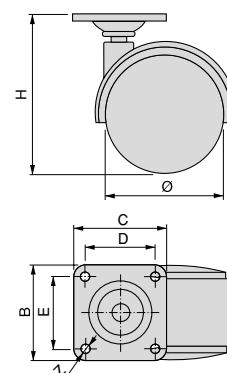

Drawer cabinet castors with bolt

Kółka do szafek szufladowych z trzpieniem

Description/Opis	Diametre/Średnica	Load/Ladunek	A	H	Finishing/Wykończenie	Packaging/Opakowanie	Cod.
without brake/bez hamulca	40	25 Kg	38	50	Black plastic/ Czarny plastik	200 Unit/Szt	3037817

Plastic, Steel/Plastik, Stal

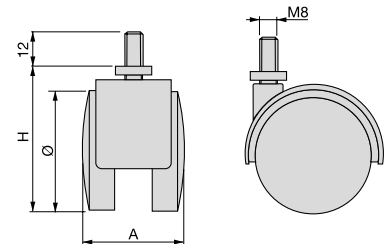

Drawer cabinet castors with nut

Kółka do szafek szufladowych z nakrętką

Description/Opis	Diametre/Średnica	Load/Ladunek	A	H	Finishing/Wykończenie	Packaging/Opakowanie	Cod.
without brake/bez hamulca	50	45 Kg	44	63	Black plastic/ Czarny plastik	200 Unit/Szt	3035617

Plastic, Steel/Plastik, Stal

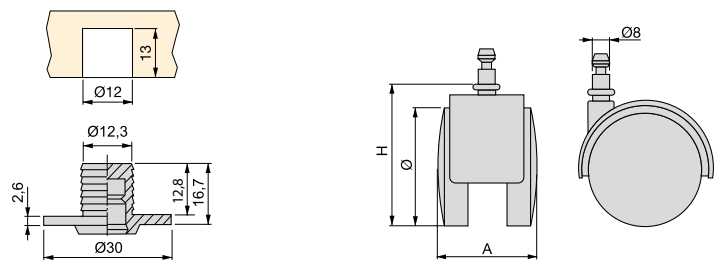

Castors for swivel top

Kółka do blatu obrotowego

Finishing/Wykończenie	Packaging/Opakowanie	Cod.
Zinc plated/Cynkowane	1000 Unit/Szt	3026105

Plastic, Steel/Plastik, Stal

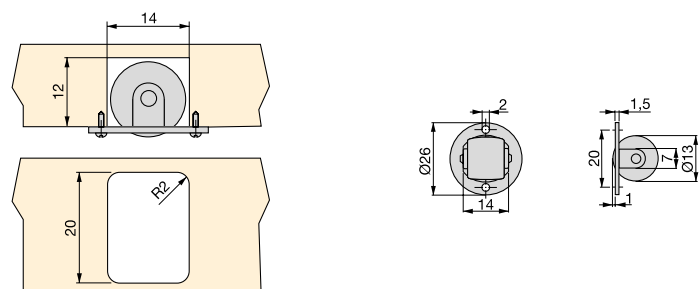

**Nivelador M6 circular Ø35x14 Gris metalizado**  
**Nivelador M6 circular Ø35x14**

Diámetro/Diámetro	Acabado/Acabamento	Embalaje/Embalagem	Cod.
35	Pintado aluminio/Pintado alumínio 	200 UN/UN	3080925

Acero, Plástico/Aço, Plástico

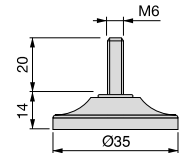

**M10 circular leveler Ø60 for furniture**  
**Regulator wysokości M10 do mebli**

Finishing/Wykończenie	Packaging/Opakowanie	Cod.
Matt chrome plated/Chromowane matowe 	200 Unit/Szt	3057564

Plastic, Steel/Plastik, Stal

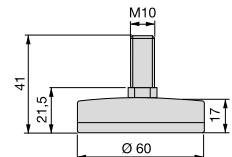

**M10 circular leveler Ø43 for furniture**  
**Regulator wysokości M10 do mebli**



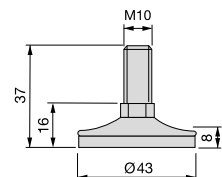

Finishing/Wykończenie	Packaging/Opakowanie	Cod.
Matt chrome plated/Chromowane matowe 	100 Unit/Szt	3057464

Plastic, Steel/Plastik, Stal



**Circular leveler Ø48 for furniture**  
**Regulator wysokości Ø48 do mebli**



H	Finishing/Wykończenie	Packaging/Opakowanie	Cod.
17	Black plastic/Czarny plastik 	400 Unit/Szt	2003817
27	Black plastic/Czarny plastik 	200 Unit/Szt	8066817
45	Black plastic/Czarny plastik 	200 Unit/Szt	8166817

Plastic, Steel/Plastik, Stal

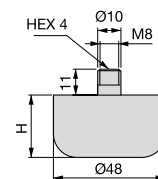
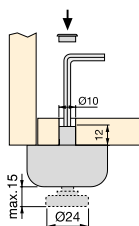

**M6 hexagonal leveler with socket for furniture**  
**Regulator wysokości M6 do mebli**

Finishing/Wykończenie	Packaging/Opakowanie	Cod.
White plastic/Biały plastik 	500 Unit/Szt	8950015

Steel/Stal

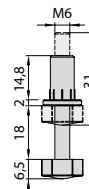
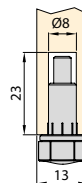

**M6 hexagonal leveler 17x5,5 for furniture**  
**Regulator wysokości M6 do mebli**

H	Finishing/Wykończenie	Packaging/Opakowanie	Cod.
22	Zinc plated/Cynkowane 	1000 Unit/Szt	3049905
27	Zinc plated/Cynkowane 	1000 Unit/Szt	3050005
32	Zinc plated/Cynkowane 	1000 Unit/Szt	3050105

Plastic, Steel/Plastik, Stal

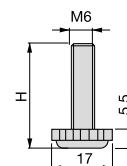



**M6 hexagonal leveler 17x10 for furniture**

Regulator wysokości M6 do mebli

H	Finishing/Wykończenie	Packaging/Opakowanie	Cod.
21	Zinc plated/Cynkowane	1000 Unit/Szt	8000605
27	Zinc plated/Cynkowane	1000 Unit/Szt	8000505

Plastic, Steel/Plastik, Stal

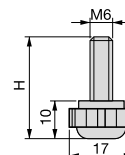

**M8 or M10 hexagonal leveler for furniture**

Niwelator M8 lub M10 Hex do mebli

H	F	Finishing/Wykończenie	Packaging/Opakowanie	Cod.
38	M8	Zinc plated/Cynkowane	500 Unit/Szt	3000405
39	M10	Zinc plated/Cynkowane	500 Unit/Szt	3044805

Plastic, Steel/Plastik, Stal

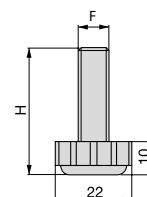

**M10 circular leveler Ø51 for furniture**

Regulator wysokości M10 do mebli

Finishing/Wykończenie	Packaging/Opakowanie	Cod.
Natural zamak/Znal naturalny	150 Unit/Szt	8069601

Plastic, Steel, Zamak/Plastik, Stal, Znal

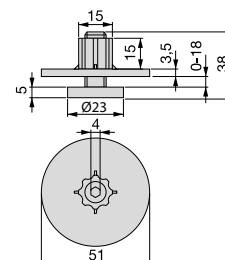
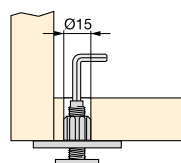

**M10 circular leveller Ø23 with cover for furniture**  
**Regulator wysokości M10 do mebli**



H	Finishing/Wykończenie	Packaging/Opakowanie	Cod.
38	Zinc plated/Cynkowane	500 Unit/Szt	9016905
46	Zinc plated/Cynkowane	500 Unit/Szt	3008105
61	Zinc plated/Cynkowane	500 Unit/Szt	3008205
80	Zinc plated/Cynkowane	250 Unit/Szt	3041505

Plastic, Steel/Plastik, Stal

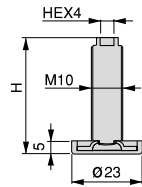
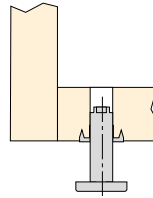

**Bracket for M10 circular leveller Ø23 for furniture**  
**Wspornik do mebli**

Finishing/Wykończenie	Packaging/Opakowanie	Cod.
Zinc plated/Cynkowane	250 Unit/Szt	3196005

Steel/Stal

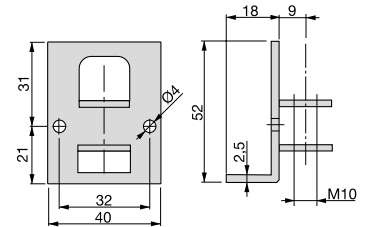

**M10 circular leveller Ø23 with cover and bracket for furniture**  
**Regulator wysokości M10 do mebli**



Finishing/Wykończenie	Packaging/Opakowanie	Cod.
Zinc plated/Cynkowane	120 Unit/Szt	3016805

Plastic, Steel/Plastik, Stal

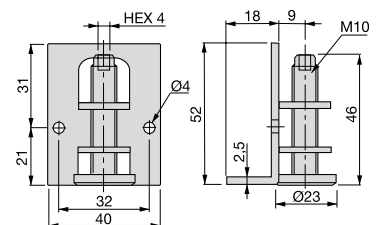
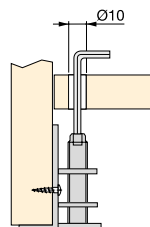

**M10x22 internal leveler with inserts for furniture**  
**Regulator wysokości M10 do mebli**

H	Finishing/Wykończenie	Packaging/Opakowanie	Cod.
38	Zinc plated/Cynkowane	100 Unit/Szt	8000905
61	Zinc plated/Cynkowane	100 Unit/Szt	8001005

Plastic, Steel, Zamak/Plastik, Stal, Znal

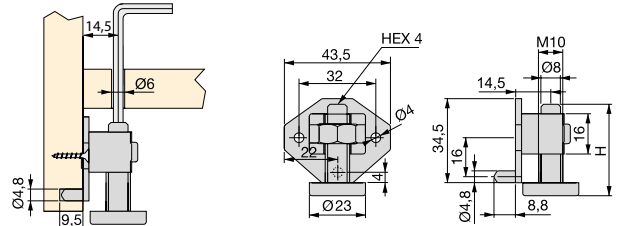

**M10x38/61 internal leveler for furniture**  
**Regulator wysokości M10 do mebli**

Finishing/Wykończenie	Packaging/Opakowanie	Cod.
Black plastic/Czarny plastik	200 Unit/Szt	8090017

Plastic, Zamak/Plastik, Znal

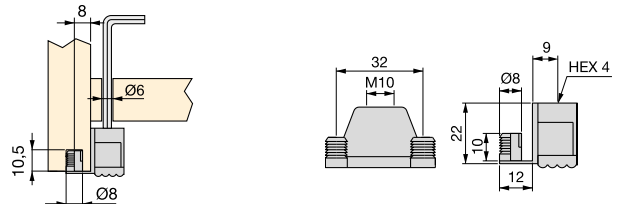

**M10x22 internal leveler for furniture**  
**Wewnętrzny regulator wysokości do mebli**

Finishing/Wykończenie	Packaging/Opakowanie	Cod.
Black plastic/Czarny plastik	200 Unit/Szt	8069417

Plastic, Zamak/Plastik, Znal

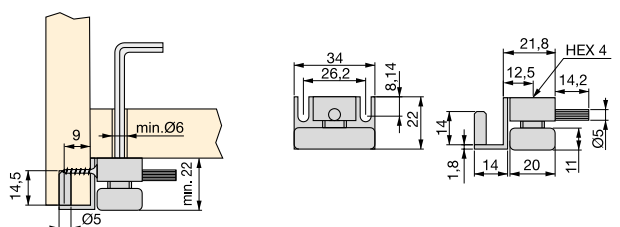

Giotto leveler for furniture

Regulator wysokości Giotto do mebli



Finishing/Wykończenie	Packaging/Opakowanie	Cod.
Natural zamak/Znal naturalny	250 Unit/Szt	4007801

Plastic, Steel, Zamak/Plastik, Stal, Znal

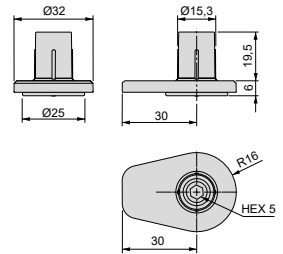
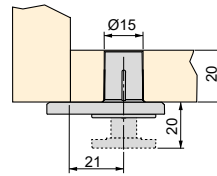

Internal leveler for clip for furniture

Wewnętrzny regulator wysokości do mebli

Diametre/Średnica	Finishing/Wykończenie	Packaging/Opakowanie	Cod.
8	Black plastic/Czarny plastik	100 Unit/Szt	8001317

Plastic, Steel/Plastik, Stal

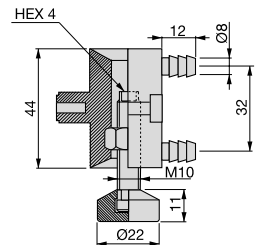
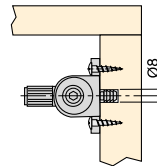

Ledown circular leveler Ø12 for furniture

Ledown do mebli Ø12



A	Finishing/Wykończenie	Packaging/Opakowanie	Cod.
30	Zinc plated/Cynkowane	200 Unit/Szt	2023805
38	Zinc plated/Cynkowane	150 Unit/Szt	2023905
58	Zinc plated/Cynkowane	100 Unit/Szt	2024005
70	Zinc plated/Cynkowane	150 Unit/Szt	3008305

Plastic, Steel, Zamak/Plastik, Stal, Znal

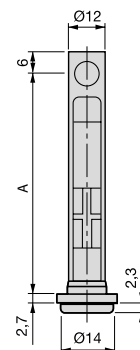
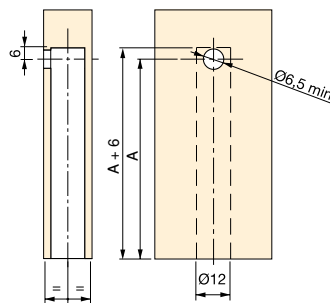

GLIDES / PODKŁADKI FILCOWE

Slider Of plastic Ø14,5 with pin

Śliski Plastik

Finishing/Wykończenie	Packaging/Opakowanie	Cod.
White plastic/Biały plastik	1000 Unit/Szt	9001415
Brown plastic/Brązowy plastik	1000 Unit/Szt	9001416
Black plastic/Czarny plastik	1000 Unit/Szt	9001417

Plastic, Steel/Plastik, Stal

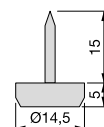

Slider Of plastic glide without inserts  
Śliski Plastik

Finishing/Wykończenie	Packaging/Opakowanie	Cod.
Brown plastic/Brązowy plastik 	1000 Unit/Szt	9229816

Plastic/Plastik

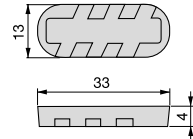

Slider Of plastic glide with inserts  
Śliski Ślizgacz z trzpieniami

Finishing/Wykończenie	Packaging/Opakowanie	Cod.
Black plastic/Czarny plastik 	5000 Unit/Szt	9017517

Plastic/Plastik

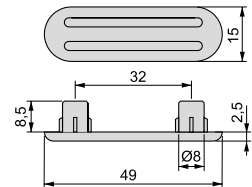
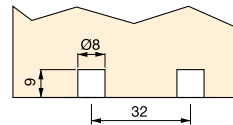

Slider Of plastic Ø17,5 glide with insert  
Śliski Okrągłe

Finishing/Wykończenie	Packaging/Opakowanie	Cod.
Black plastic/Czarny plastik 	5000 Unit/Szt	9055817

Plastic/Plastik

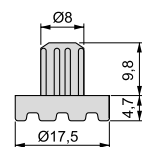
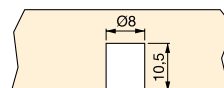







## Circular adhesives felts for furniture

## Okrągłe filce klejące do mebli



Diametre/Średnica	Finishing/Wykończenie	Packaging/Opakowanie	N° pieces/Liczba elementów	Cod.
16	Brown plastic/ Brązowy plastik 	1 LOT/Partia	150 units/150 jednostki	2038016
30	Brown plastic/ Brązowy plastik 	1 LOT/Partia	63 units/63 jednostki	2038316
24	Brown plastic/ Brązowy plastik 	1 LOT/Partia	108 units/108 jednostki	2038216
20	Brown plastic/ Brązowy plastik 	1 LOT/Partia	150 units/150 jednostki	2038116
40	Brown plastic/ Brązowy plastik 	1 LOT/Partia	36 units/36 jednostki	2038516

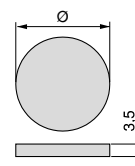

Fibre/Włókno



## Square adhesives felts for furniture

## Kleje kwadratowe filce do mebli



Height/Wysokość	Width/Szerokość	Finishing/Wykończenie	Packaging/Opakowanie	N° pieces/Liczba elementów	Cod.
20	20	Brown plastic/ Brązowy plastik 	1 LOT/Partia	150 units/150 jednostki	2038616
25	25	Brown plastic/ Brązowy plastik 	1 LOT/Partia	96 units/96 jednostki	2038716
30	30	Brown plastic/ Brązowy plastik 	1 LOT/Partia	63 units/63 jednostki	2038816

Fibre/Włókno

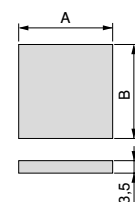
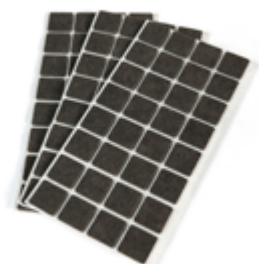

## Rectangular adhesives felts for furniture

## Filce klejące prostokątne do mebli



Width/Szerokość	Finishing/Wykończenie	Packaging/Opakowanie	N° pieces/Liczba elementów	Cod.
250	Brown plastic/ Brązowy plastik 	1 LOT/Partia	3 units/3 jednostki	2038916

Fibre/Włókno

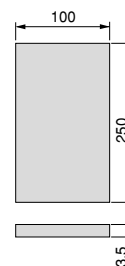

## Circular adhesive felt for furniture

## Okrągły filc samoprzylepny do mebli



Finishing/Wykończenie	Packaging/Opakowanie	Cod.
Brown plastic/Brązowy plastik 	1008 Unit/Szt	6255216

Fibre/Włókno

