

Wardrobes / Szafy

Modular structure Zero

- 236 Modular structure Zero in kit form
- 225 Modular structure Zero - Profiles and levellers
- 239 Modular structure Zero - Accessories
- 249 Zero modular structure lighting

Accessories for wardrobe

- 252 Pull Down Wardrobe Rail Lift
- 260 Wardrobe interior wardrobe rails
- 262 Supports for wardrobe interior wardrobe rails
- 269 Wall coat racks
- 275 Hack accessories
- 289 Moka accessories
- 297 Self Accessories

Modular shelving

- 303 Lader Bookcases
- 309 Jagmet structure

Profiles and accessories for wooden doors

- 313 Adige handle profiles
- 314 Free Face handle profiles
- 315 Free Rapid handle profiles
- 316 Styl handle profiles
- 318 Rhodes handle profiles
- 317 Dust excluder strips
- 318 Edging profiles Face
- 319 Door truss

Aluminium doors

- 320 Free doors
- 324 Plus profiles
- 326 Accessories for Plus profiles

Struktura modułowa Zero

- 236 Struktura modułowa Zero w komplecie
- 225 Struktura modułowa Zero - Profile i niwelatory
- 239 Struktura modułowa Zero - Akcesoria
- 249 Oświetlenie struktury modułowej Zero

Akcesoria do szafy

- 252 Wieszak składany
- 260 Drążki na wieszaki
- 262 Wsporniki do drążków na wieszaki
- 269 Wieszak ścienny
- 275 Akcesoria Hack
- 289 Akcesoria Moka
- 297 Akcesoria Self

Regał modułowy

- 303 Szafka Lader
- 309 System Jagmet

Profile i akcesoria do drzwi drewnianych

- 313 Profile uchwytowe Adige
- 314 Profile uchwytowe Free Face
- 315 Profile uchwytowe Free Rapid
- 316 Profile uchwytowe Styl
- 318 Profile uchwytowe Rhodes
- 317 Taśmy przeciwpyłowe
- 318 Profile krawędziowe Face
- 319 Napinacze do drzwi

Drzwi aluminiowe

- 320 Drzwi Free
- 324 Profile Plus
- 326 Akcesoria do profili Plus

Zero modular structure Zero modułowa struktura

A simple, functional and design-oriented system.
Prosty, funkcjonalny i zorientowany na design system.

wall system / system ścienny



ceiling system / system sufitowy



Try the configurator on our website / Wypróbuj konfigurator na naszej stronie internetowej:
<https://www.emuca.com/configurator#/zero>

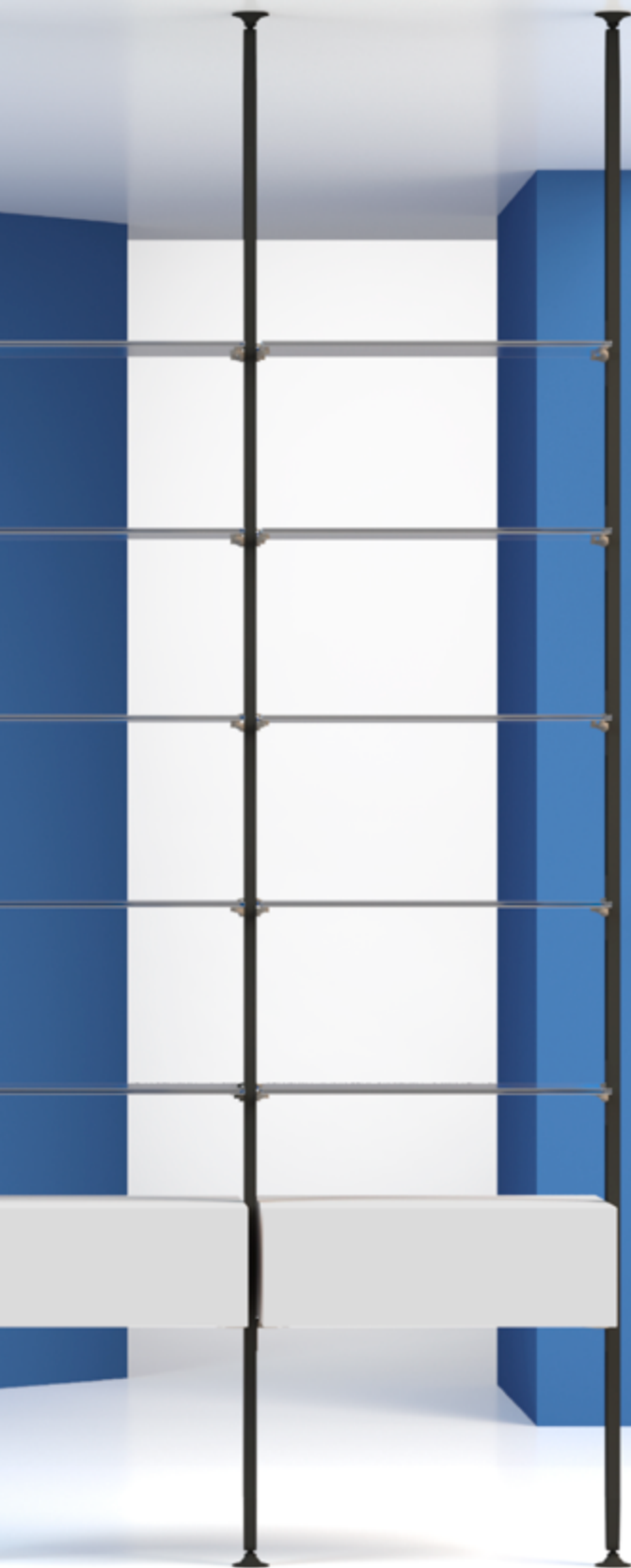

The Zero modular structure is designed to make your life easier, offering infinite possibilities for the home, dressing rooms, offices or shops. Its name is related to its main features: Zero time, Zero tools and Zero difficulties.

Modułowa struktura Zero została zaprojektowana, aby ułatwić życie, oferując nieskończone możliwości dla domu, garderoby, biura lub sklepu. Jej nazwa związana jest z jej głównymi cechami: zero czasu, zero narzędzi i zero trudności.

hanging system / system podwieszany

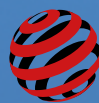

red dot winner 2022
furniture design



An ecological and sustainable system
Ekologiczny i zrównoważony system



patented, designed in
Italy and made in the
EU / opatentowany,
zaprojektowany
we Włoszech i
wyprodukowany w UE

Zero modular structure Zero modułowa struktura

Easy assembly thanks to a single tool that makes it easy to move the shelf supports.

Łatwy montaż dzięki pojedynczemu narzędziu, które umożliwia łatwe przesuwanie wsporników półek.

THE QUICKEST, SIMPLEST AND MOST INTUITIVE ASSEMBLY ON THE MARKET.

NAJSZYBSZY, NAJPROSTSZY I NAJBARDZIEJ INTUICYJNY MONTAŻ NA RYNKU.

Set of brackets for glass shelves.

Zestaw wsporników do szklanych półek.

Removable fixing tool.

Wyjmowalne narzędzie mocujące.



Exclusive patented design.

Ekskluzywna opatentowana konstrukcja.



Adjustment tool.

Narzędzie do regulacji.

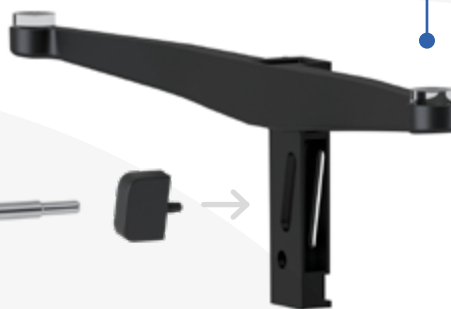

Upright for modular structures.

Stojak do konstrukcji modułowych.

With the exclusive Zero profile system, no tools are required. Adjust and position the shelves without having to dismantle any element and without special tools.

Dzięki wyjątkowemu systemowi profili Zero nie są wymagane żadne narzędzia. Regulacja i pozycjonowanie półek bez konieczności demontażu jakiegokolwiek elementu i bez specjalnych narzędzi.



Scan the QR code to watch the video showing our revolutionary, easy-to-assemble system.

Zeskanuj kod QR, aby obejrzeć film przedstawiający nasz rewolucyjny, łatwy w montażu system.

One product, several customisable solutions.
Jeden produkt, kilka konfigurowalnych rozwiązań.

A



B

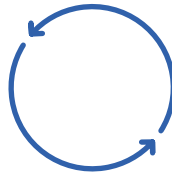

Different compositions can be created with the same elements.

Z tych samych elementów można tworzyć różne kompozycje.

One expandable system.
Jeden system z możliwością rozbudowy.

A



+



As needs change, the system can be recomposed and expanded.

W miarę zmieniających się potrzeb, system można ponownie skomponować i rozbudować.

B



A sustainable system because its function can be modified.
Zrównoważony system, ponieważ jego funkcja może być modyfikowana.

A

CABINET / SZAFKA

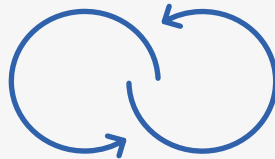

A wardrobe solution can easily be transformed into a living room by changing the position of the components.

Rozwiązanie szafy można łatwo przekształcić w salon, zmieniając położenie komponentów.

B

LIVING ROOM / SALON



Vertical Zero Pionowe Zero

The levelling feet allow a height adjustment of 10 mm and are equipped with a ball and socket joint for easy mounting. The round foot has an elegant slim design and the rectangular foot is the perfect solution for wall mounting.

Nóżki poziomujące umożliwiają regulację wysokości w zakresie 10 mm i są wyposażone w przegub kulowy ułatwiający montaż. Okrągła nóżka ma elegancki, smukły kształt, a prostokątna nóżka jest idealnym rozwiązaniem do montażu na ścianie.

10mm



The textured finish in stone grey or black, the latest trend in furniture design, stands out.

Teksturowane wykończenie w kolorze szarym lub czarnym, najnowszy trend w projektowaniu mebli, wyróżnia się.



**MOUNTING
SYSTEMS
SYSTEMY
MONTAŻOWE**

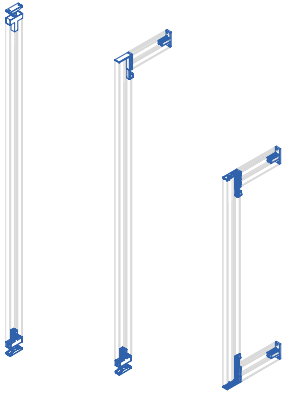

Mounting structure I
(floor - ceiling)
Konstrukcja montażowa I
(podłoga - sufit)

Mounting structure L
(floor - wall)
Konstrukcja montażowa L
(podłoga - ściana)

Mounting structure C
(wall - wall)
Konstrukcja montażowa C
(ściana - ściana)



**INFINITE
POSSIBILITIES
NIESKOŃCZONE
MOŻLIWOŚCI**

Zero profiles and levellers
Profile i niwelatory Zero



Profile for Zero modular structures

Profil do tworzenia struktur modułowych Zero



Longitude/Długość	Finishing/Wykończenie	Packaging/Opakowanie	Cod.
2,35 m	Painted stone grey/Malowany na kolor kamienno-szary	8 Unit/Szt	7020149
2,9 m	Painted stone grey/Malowany na kolor kamienno-szary	8 Unit/Szt	7020249
2,35 m	Textured black painted/Teksturowana czerni	8 Unit/Szt	7020154
2,9 m	Textured black painted/Teksturowana czerni	8 Unit/Szt	7020254

Aluminium/Aluminium

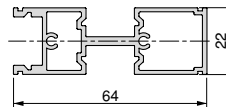

Hardware kit for mounting Zero profiles to the wall

Zestaw sprzętu do montażu profili Zero do ścian



Finishing/Wykończenie	Packaging/Opakowanie	Cod.
Painted stone grey/Malowany na kolor kamienno-szary	4 Pair/Kpl.	7031949
Textured black painted/Teksturowana czerni	4 Pair/Kpl.	7031954

Plastic, Zamak/Plastik, Znal

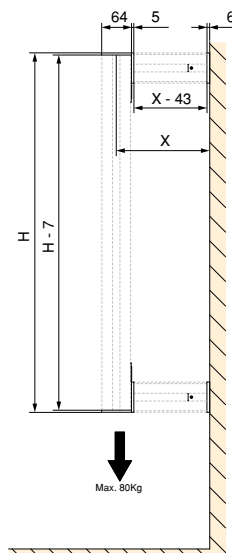
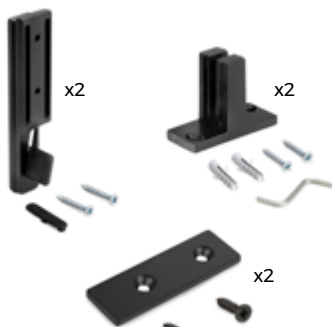

Tool assembly set for Zero rectangular leveller (Floor - Wall)
 Zestaw okuć do montażu profili Zero w kształcie litery (Podłoga - Ściana)



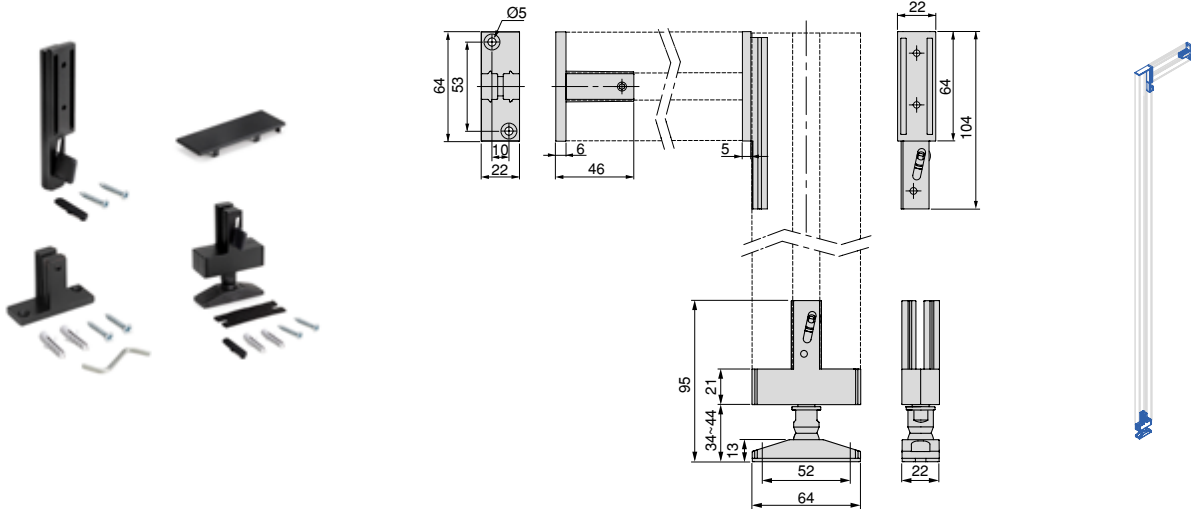

Finishing/Wykończenie	Packaging/Opakowanie	Cod.
Textured black painted/Teksturowana czerni 	8 Unit/Szt	7031054

Plastic, Zamak/Plastik, Znal



Set of rectangular levelers for mounting Zero profiles (Floor - Ceiling)
 Zestaw prostokątnych regulatorów wysokości do montażu profili Zero (Podłoga - Sufit)



Finishing/Wykończenie	Packaging/Opakowanie	Cod.
Painted stone grey/Malowany na kolor kamienno-szary 	16 Unit/Szt	7031149
Textured black painted/Teksturowana czerni 	16 Unit/Szt	7031154

Plastic, Zamak/Plastik, Znal

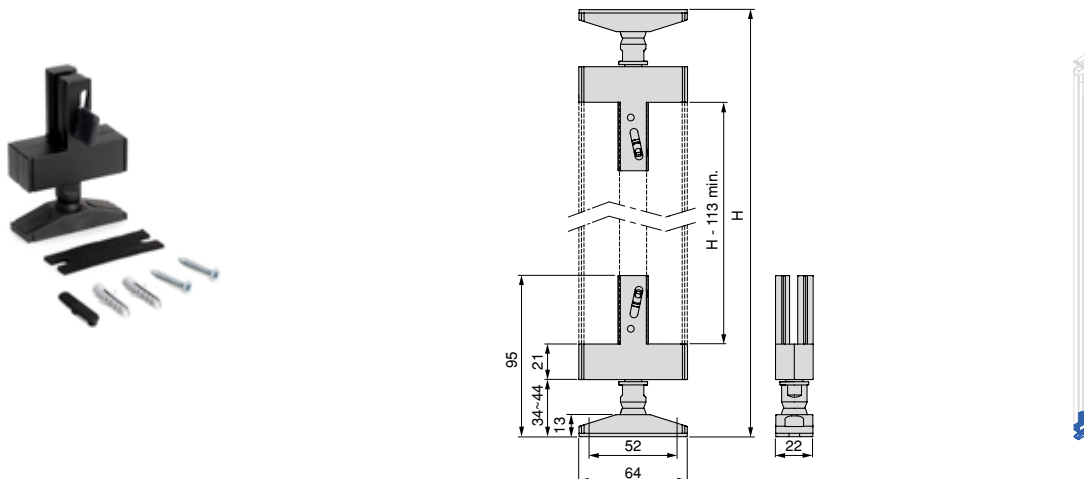

Assembly kit with circular levelling device for assembling Zero profiles (Floor - Wall)

Zestaw okuć z niwelatorem kołowym do montażu profili zerowych (Podłoga - ściana)

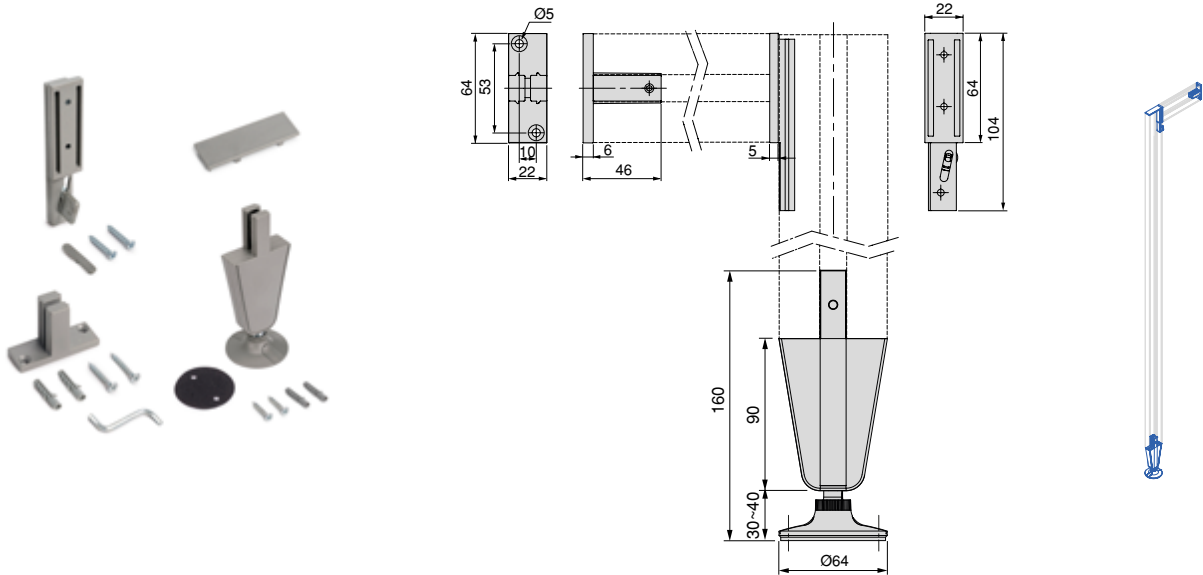

Finishing/Wykończenie	Packaging/Opakowanie	Cod.
Painted stone grey/Malowany na kolor kamienno-szary 	8 Unit/Szt	7033549

Plastic, Zamak/Plastik, Znal



Set of circular levelers for mounting Zero profiles (Floor - Ceiling)

Zestaw niwelatorów okrągłych do montażu profili Zero (Podłoga - Sufit)

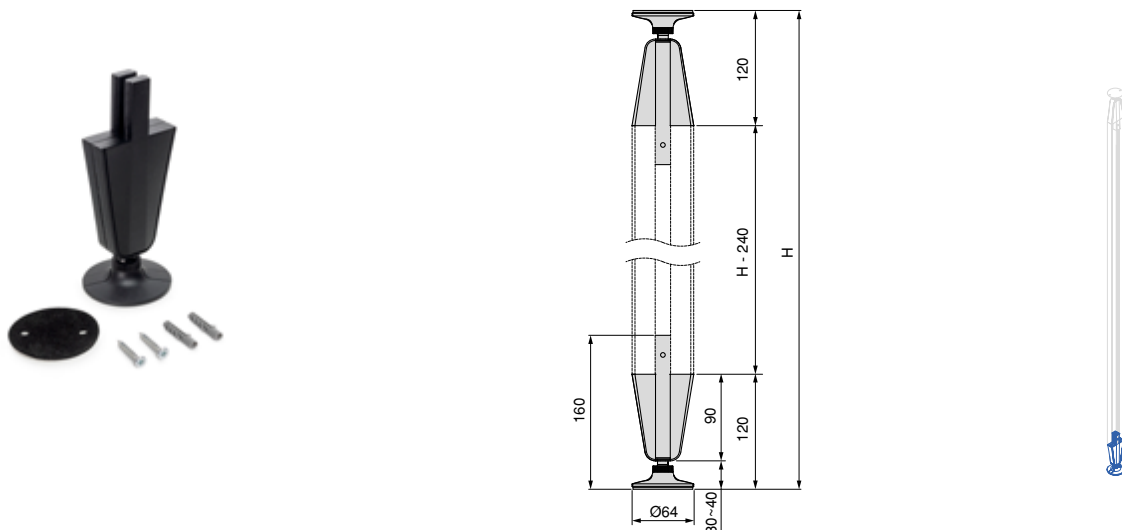

Finishing/Wykończenie	Packaging/Opakowanie	Cod.
Painted stone grey/Malowany na kolor kamienno-szary 	16 Unit/Szt	7032749
Textured black painted/Teksturowana czerni 	16 Unit/Szt	7032754

Plastic, Zamak/Plastik, Znal



Piece to affix the Zero profile to the wall
Element do montażu ściennego profilu Zero



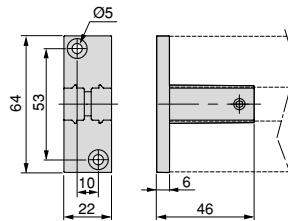

Finishing/Wykończenie	Packaging/Opakowanie	Cod.
Painted stone grey/Malowany na kolor kamienno-szary 	8 Unit/Szt	7031749
Textured black painted/Teksturowana czerni 	8 Unit/Szt	7031754

Zamak/Znal



Joint between Zero profiles
Element do łączenia profili Zero



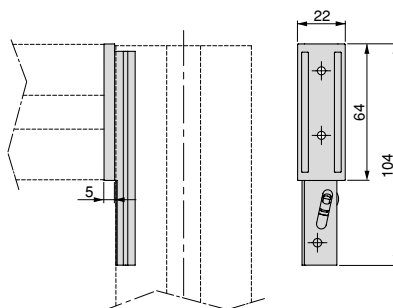

Finishing/Wykończenie	Packaging/Opakowanie	Cod.
Painted stone grey/Malowany na kolor kamienno-szary 	8 Unit/Szt	7031249
Textured black painted/Teksturowana czerni 	8 Unit/Szt	7031254

Zamak/Znal



Cover cap for Zero profile
 Zaślepka do profilu Zero

Finishing/Wykończenie	Packaging/Opakowanie	Cod.
Black plastic/Czarny plastik 	20 Unit/Szt	7032517
Stone grey plastic/Plastik kamiennoszary 	20 Unit/Szt	7032536

Plastic/Plastik

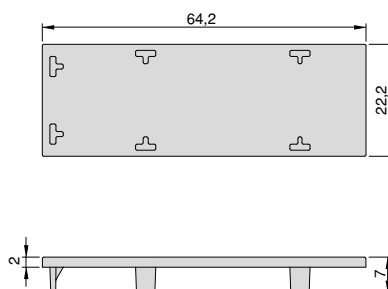

Tool for adjustment of Zero system accessories
 Narzędzie do regulacji akcesoriów systemu Zero

Finishing/Wykończenie	Packaging/Opakowanie	Cod.
Black plastic/Czarny plastik 	8 Unit/Szt	7032617

Plastic, Steel/Plastik, Stal



Zero modular structure kit with tools and profiles to be assembled in the floor and the wall shape
 Zestaw struktury modułowej Zero z okuciami i profilami do montażu do podłogi oraz do ściany



Description/Opis	N° pieces/Liczba elementów	Finishing/Wykończenie	Packaging/Opakowanie	Cod.
2 Profiles/2 Profil	2 UN/2 UN	Textured black painted/Teksturowana czerni	1 KIT/Zestaw	7022054

Aluminium, Plastic, Zamak/Aluminium, Plastik, Znal

KITS

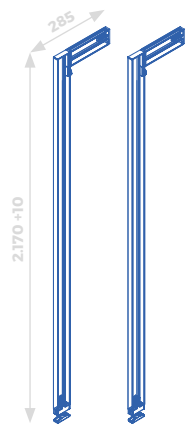
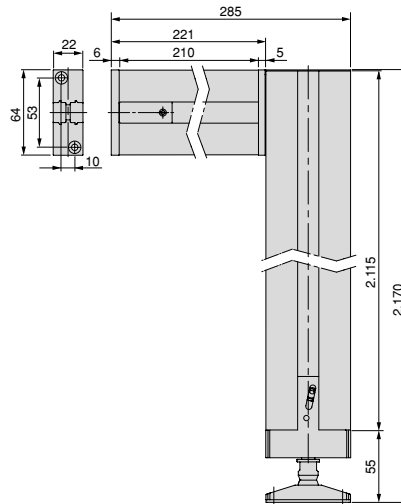
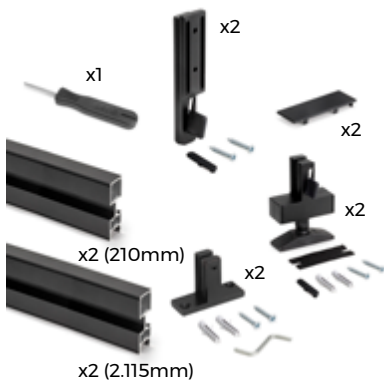

Zero modular structure kit with tools and profiles to be assembled in the floor and the wall shape
 Zestaw struktury modułowej Zero z okuciami i profilami do montażu do podłogi oraz do ściany



Description/Opis	N° pieces/Liczba elementów	Finishing/Wykończenie	Packaging/Opakowanie	Cod.
3 Profiles/3 Profil	3 UN/3 UN	Textured black painted/Teksturowana czerni	1 KIT/Zestaw	7022154

Aluminium, Plastic, Zamak/Aluminium, Plastik, Znal

KITS

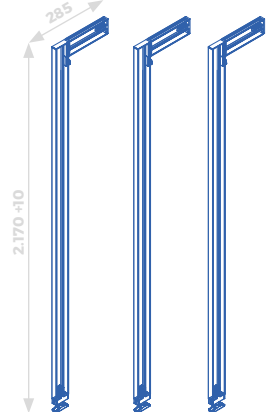
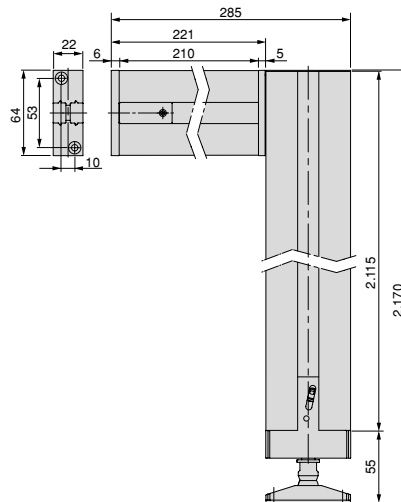
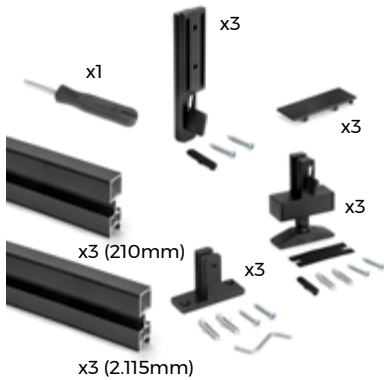

Kit circular leveller to affix profile to floor/wall and Zero profile

Zestaw konstrukcji modułowej Zero z okuciami i profilami do montażu na podłodze i ścianie z okrągłym urządzeniem poziomującym

Description/Opis	N° pieces/Liczba elementów	Finishing/Wykończenie	Packaging/Opakowanie	Cod.
2 Profiles/2 Profil	2 UN/2 UN	Painted stone grey/Malowany na kolor kamienno-szary	1 KIT/Zestaw	7023649

Aluminium, Plastic, Zamak/Aluminium, Plastik, Znal

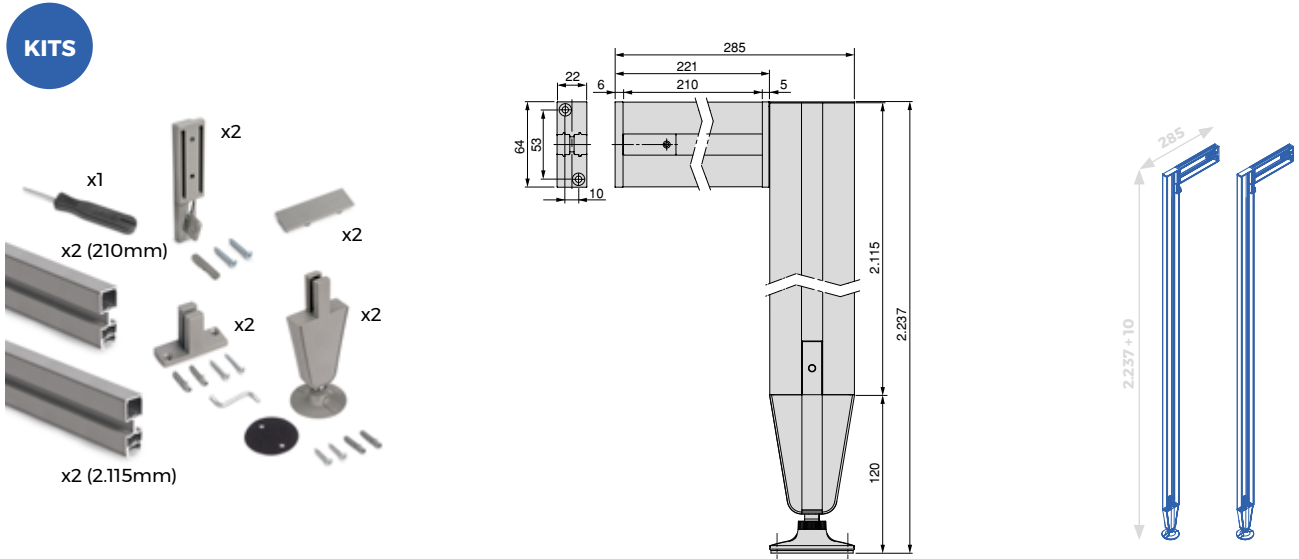

Kit circular leveller to affix profile to floor/wall and Zero profile

Zestaw konstrukcji modułowej Zero z okuciami i profilami do montażu na podłodze i ścianie z okrągłym urządzeniem poziomującym

Description/Opis	N° pieces/Liczba elementów	Finishing/Wykończenie	Packaging/Opakowanie	Cod.
3 Profiles/3 Profil	3 UN/3 UN	Painted stone grey/Malowany na kolor kamienno-szary	1 KIT/Zestaw	7023749

Aluminium, Plastic, Zamak/Aluminium, Plastik, Znal

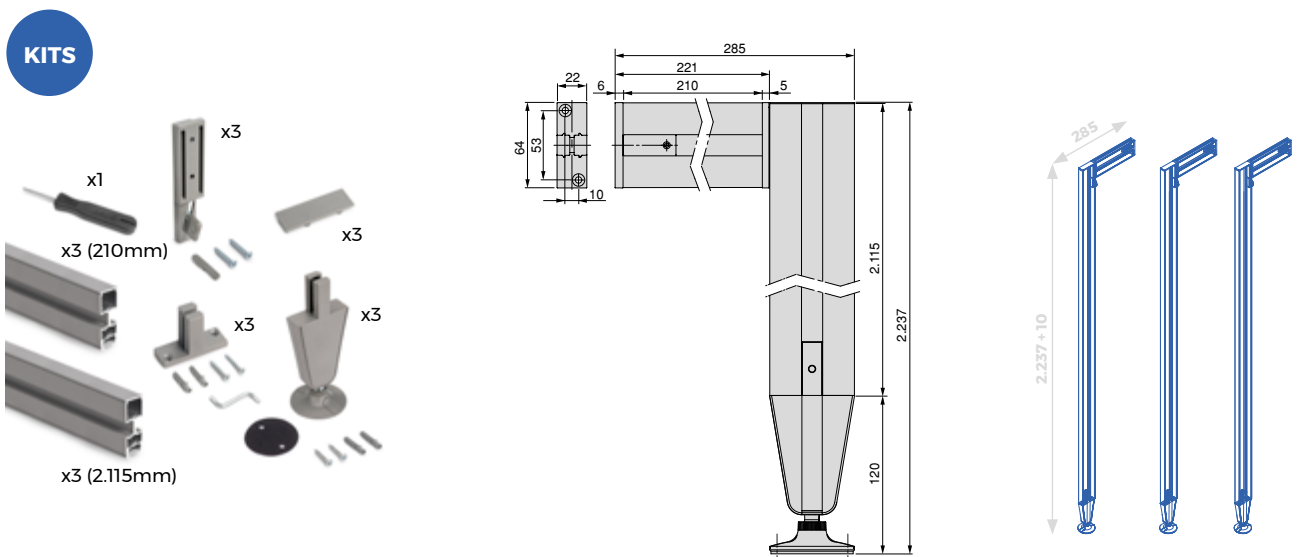

Zero modular structure kit with fittings and profiles for floor and ceiling mounting with rectangular leveller

Zestaw konstrukcji modułowej Zero z okuciami i profilami do montażu na podłodze i suficie z prostokątnym niwelatorem

Description/Opis	N° pieces/Liczba elementów	Finishing/Wykończenie	Packaging/Opakowanie	Cod.
2 Profiles/2 Profil	2 UN/2 UN	Textured black painted/Teksturowana czerni	1 KIT/Zestaw	7023354

Steel, Zamak/Stal, Znal

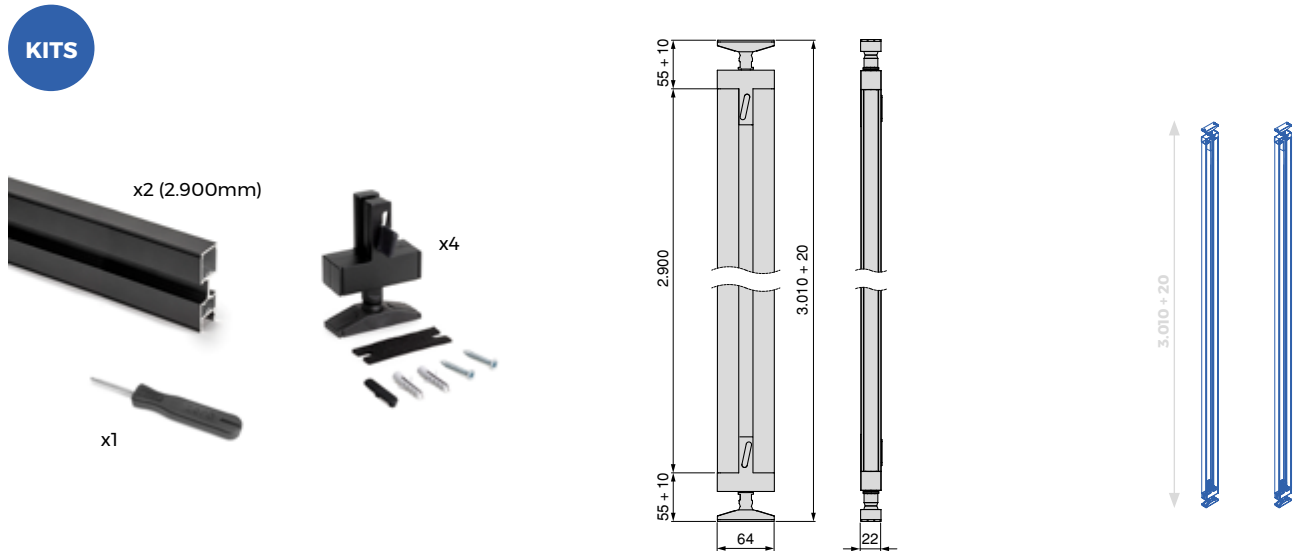

Zero modular structure kit with fittings and profiles for floor and ceiling mounting with rectangular leveller

Zestaw konstrukcji modułowej Zero z okuciami i profilami do montażu na podłodze i suficie z prostokątnym niwelatorem

Description/Opis	N° pieces/Liczba elementów	Finishing/Wykończenie	Packaging/Opakowanie	Cod.
3 Profiles/3 Profil	3 UN/3 UN	Textured black painted/Teksturowana czerni	1 KIT/Zestaw	7023854

Steel, Zamak/Stal, Znal

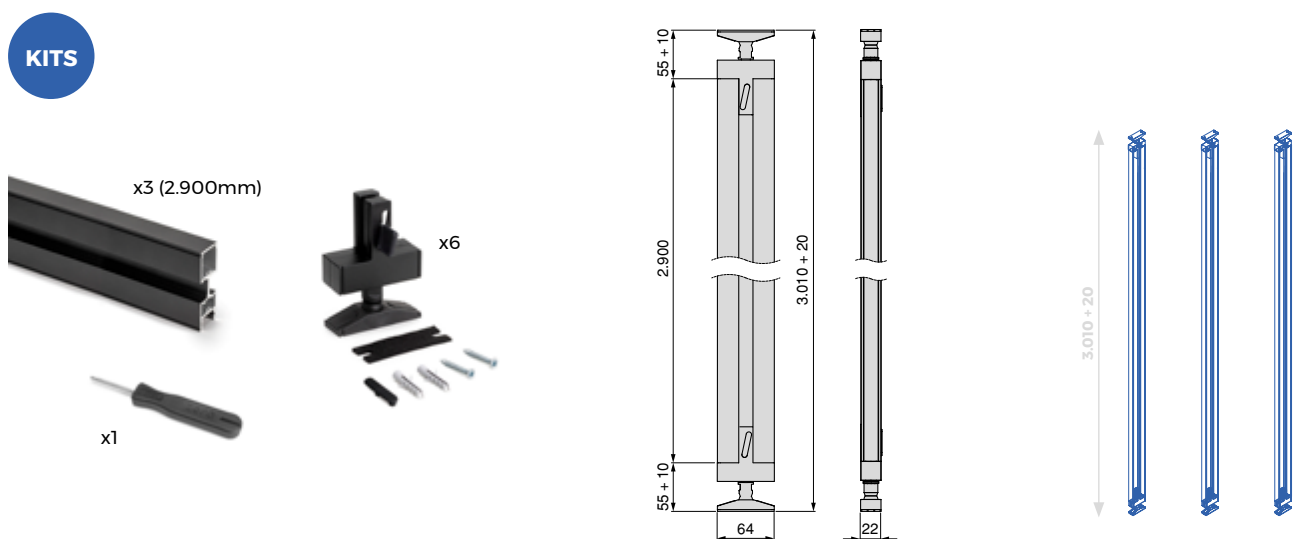

Kit circular leveller to affix profile to floor/ceiling and Zero profile

Zestaw konstrukcji modułowej Zero z okuciami i profilami do montażu na podłodze i suficie z okrągłym urządzeniem poziomującym

Description/Opis	N° pieces/Liczba elementów	Finishing/Wykończenie	Packaging/Opakowanie	Cod.
2 Profiles/2 Profil	2 UN/2 UN	Painted stone grey/Malowany na kolor kamienno-szary	1 KIT/Zestaw	7023449

Aluminium, Plastic, Zamak/Aluminium, Plastik, Znal

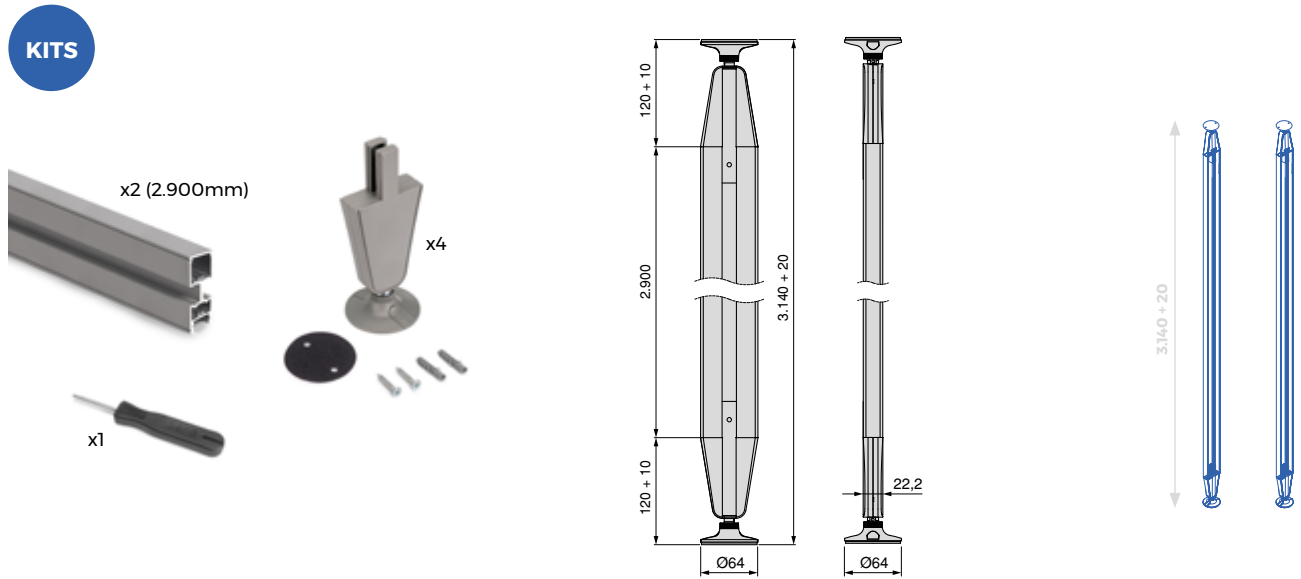

Kit circular leveller to affix profile to floor/ceiling and Zero profile

Zestaw konstrukcji modułowej Zero z okuciami i profilami do montażu na podłodze i suficie z okrągłym urządzeniem poziomującym

Description/Opis	N° pieces/Liczba elementów	Finishing/Wykończenie	Packaging/Opakowanie	Cod.
3 Profiles/3 Profil	3 UN/3 UN	Painted stone grey/Malowany na kolor kamienno-szary	1 KIT/Zestaw	7023949

Aluminium, Plastic, Zamak/Aluminium, Plastik, Znal

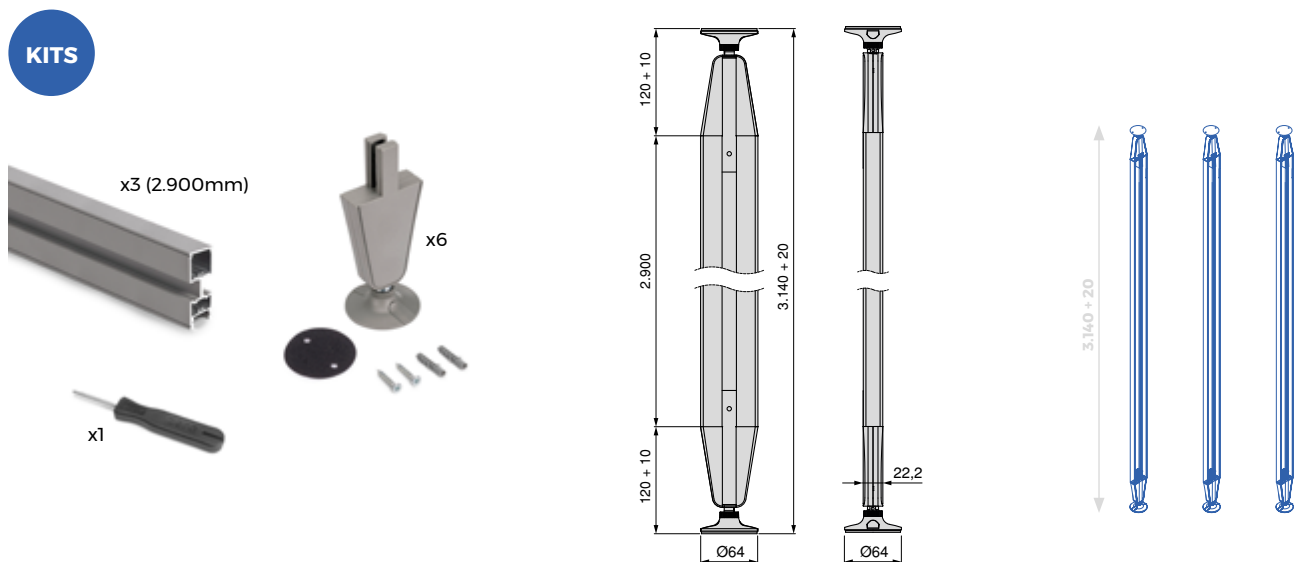

Horizontal Zero Poziom Zero

TYPES OF SHELVES RODZAJE PÓŁEK

Choose between black or stone grey textured paint.

Do wyboru czarna lub kamienna szara farba strukturalna.



Glass shelf support.
Szklany wspornik półki.

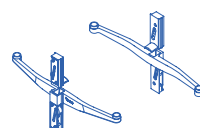

Support for wooden shelf.
Drewniany wspornik półki.

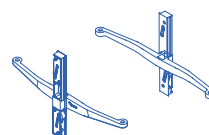

Aluminium shelf support.
Aluminiowy wspornik półki.

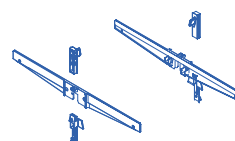



Support for module.
Modułowy wspornik półki.

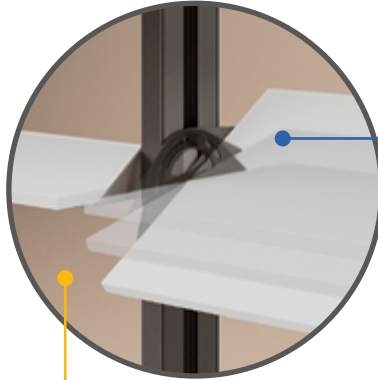
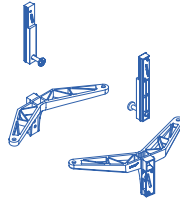

Shelf support with adjustable inclination.
Wspornik półki z regulacją nachylenia.

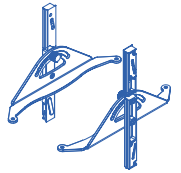

5 different shelf
inclinations.
5 różnych pochyleń
półki.

Capacity per
shelf.
Pojemność na
półkę.

Capacity per
module.
Pojemność na
moduł.

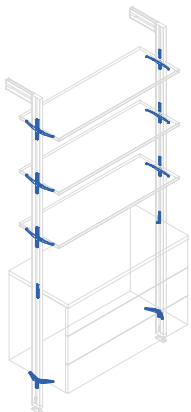

100kg

120kg

Zero modular structure kit with hardware for wall-mounted assembly
Zestaw konstrukcji modułowej Zero z okuciami do montażu na ścianie



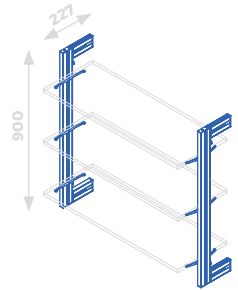
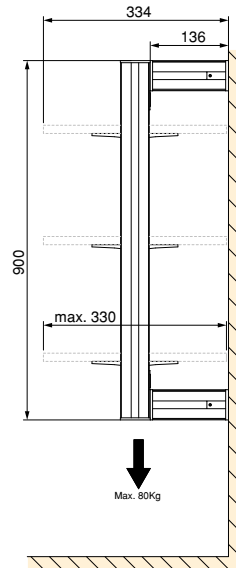

Finishing/Wykończenie	Packaging/Opakowanie	Cod.
Painted stone grey/Malowany na kolor kamienno-szary 	1 KIT/Zestaw	7021849
Textured black painted/Teksturowana czerni 	1 KIT/Zestaw	7021854

Aluminium, Zamak/Aluminium, Znal



Zero support kit for wooden shelves and module
Zestaw wsporników Zero do półek drewnianych i modułów



Finishing/Wykończenie	Packaging/Opakowanie	Cod.
Painted stone grey/Malowany na kolor kamienno-szary 	1 KIT/Zestaw	7022249
Textured black painted/Teksturowana czerni 	1 KIT/Zestaw	7022254

Plastic, Zamak/Plastik, Znal

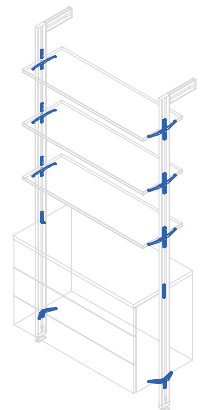

Zero Kit supports for wooden shelves and hanging rail

Zestaw wsporników Zero do półek z drewna i drążka do zawieszania



Finishing/Wykończenie	Packaging/Opakowanie	Cod.
Painted stone grey/Malowany na kolor kamienno-szary 	1 KIT/Zestaw	7022349
Textured black painted/Teksturowana czerni 	1 KIT/Zestaw	7022354

Aluminium, Plastic, Zamak/Aluminium, Plastik, Znal

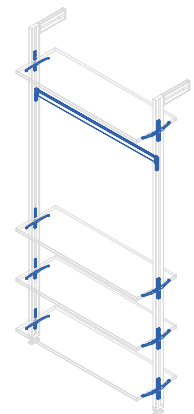

KITS



Zero support kit for wooden and module shelves and hanging rail

Zestaw wsporników Zero do półek z drewna, modułu i drążka na wieszaki



Finishing/Wykończenie	Packaging/Opakowanie	Cod.
Painted stone grey/Malowany na kolor kamienno-szary 	1 KIT/Zestaw	7022449
Textured black painted/Teksturowana czerni 	1 KIT/Zestaw	7022454

Aluminium, Plastic, Zamak/Aluminium, Plastik, Znal

KITS

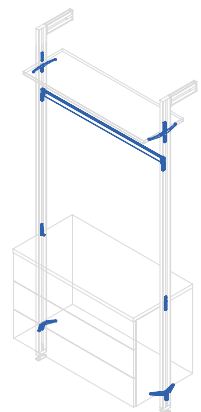



Wooden support / Module support
Wsparcie drewna / Wsparcie modułów



Zero support set for wooden shelf
Zestaw wsporników Zero do półki drewnianej



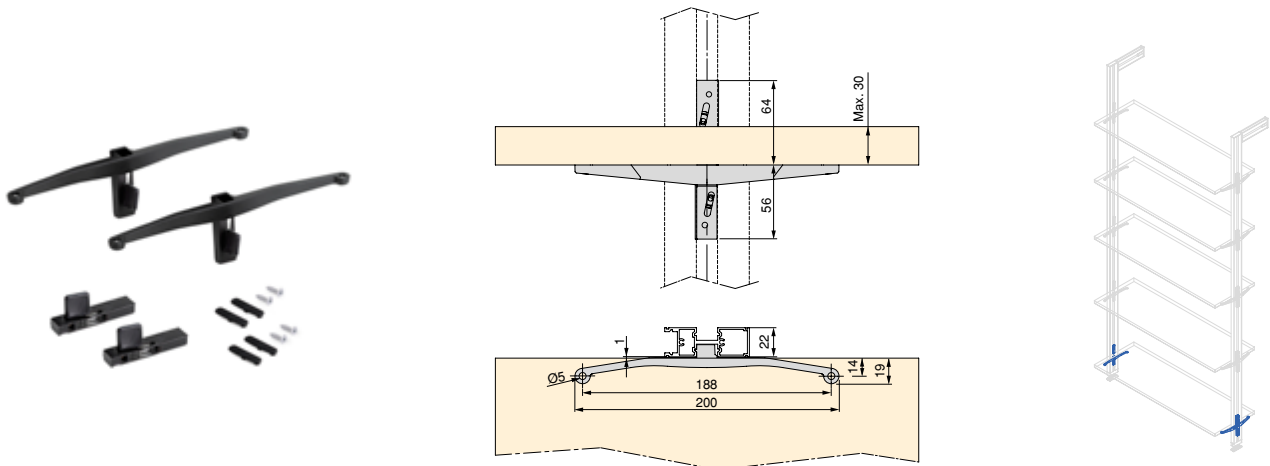

Finishing/Wykończenie	Packaging/Opakowanie	Cod.
Painted stone grey/Malowany na kolor kamienno-szary 	5 Unit/Szt	7031349
Textured black painted/Teksturowana czerni 	5 Unit/Szt	7031354

Zamak/Znal



Zero support kit for module
Zestaw wsporników Zero do modułu



Finishing/Wykończenie	Packaging/Opakowanie	Cod.
Painted stone grey/Malowany na kolor kamienno-szary 	5 Unit/Szt	7031549
Textured black painted/Teksturowana czerni 	5 Unit/Szt	7031554

Zamak/Znal

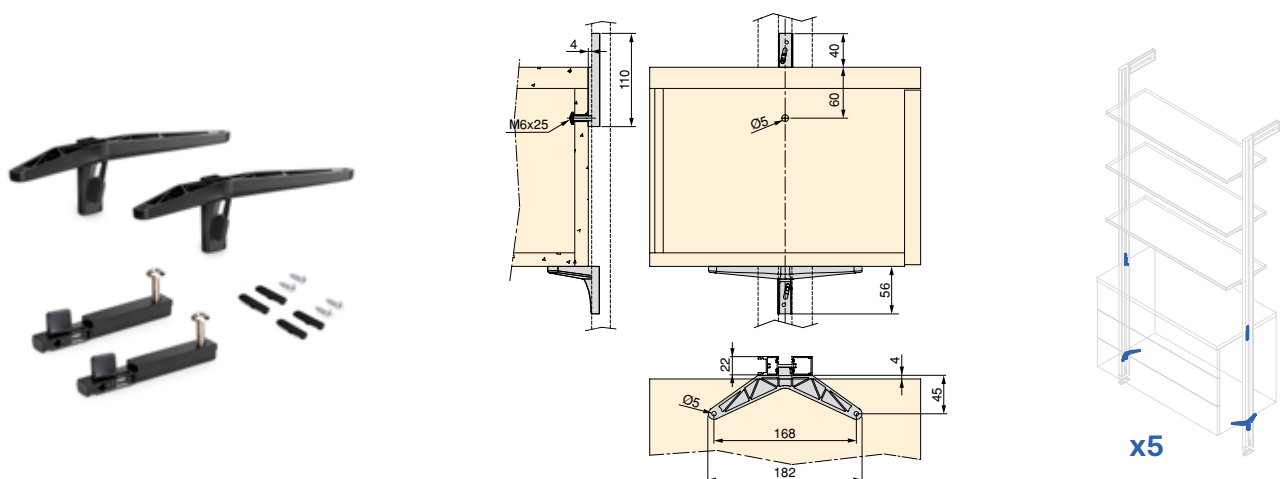



Glass support / Tilted support
Wspornik szyby / wspornik pochylony



Zero support set for glass shelf

Zestaw wsporników Zero do szklanej półki



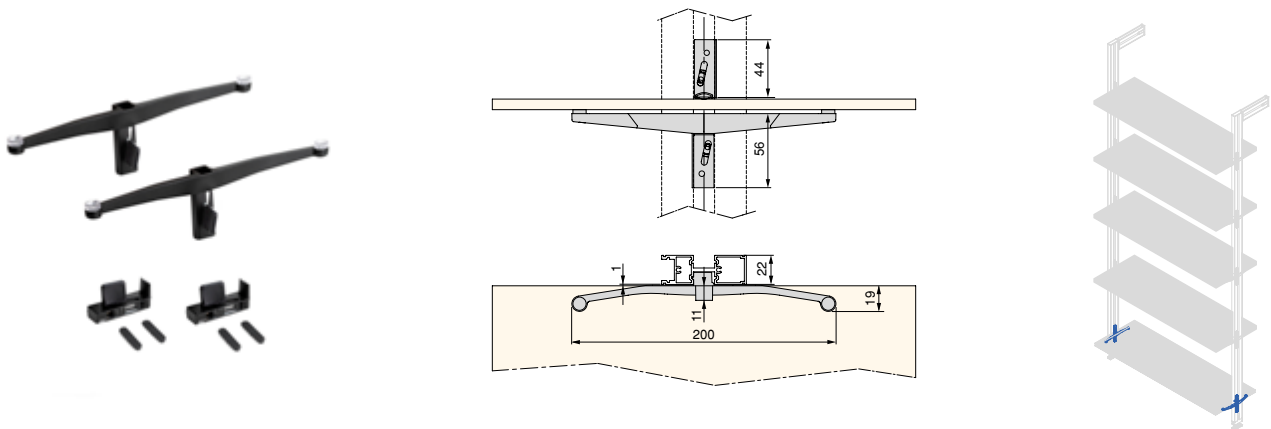

Finishing/Wykończenie	Packaging/Opakowanie	Cod.
Painted stone grey/Malowany na kolor kamienno-szary 	5 Pair/Kpl.	7031449
Textured black painted/Teksturowana czerni 	5 Pair/Kpl.	7031454

Zamak/Znal



Set of brackets for an inclined wooden shelf for the Zero modular structure

Zestaw wsporników do pochylonej półki drewnianej do konstrukcji modułowej Zero

Finishing/Wykończenie	Packaging/Opakowanie	Cod.
Painted stone grey/Malowany na kolor kamienno-szary 	2 Pair/Kpl.	7033049
Textured black painted/Teksturowana czerni 	2 Pair/Kpl.	7033054

Steel, Zamak/Stal, Znal

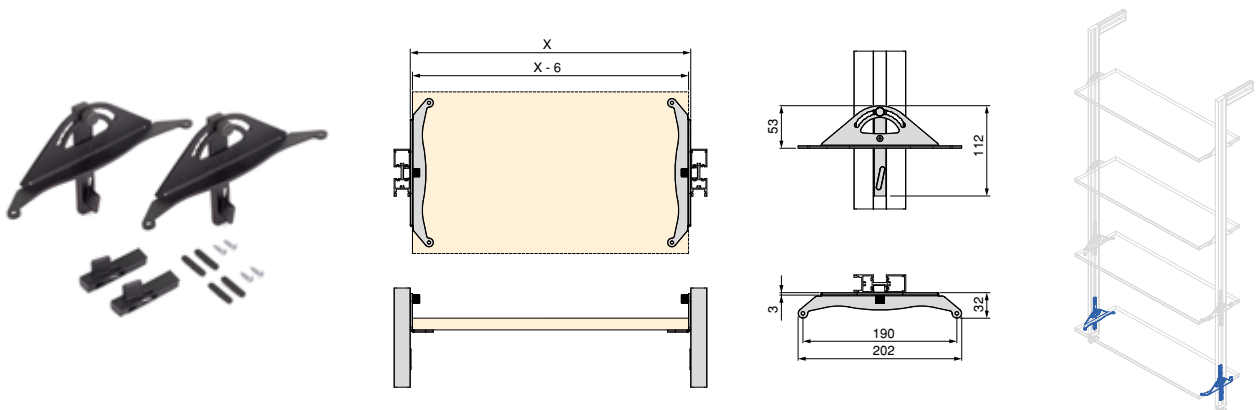

Aluminium shelf Zero Aluminiowy stojak Zero

Ideal for forming bookcases or Zero structures made entirely of aluminium.

Idealny do tworzenia regałów na książki lub konstrukcji Zero wykonanych w całości z aluminium.

KIT



Choose between black or stone grey textured paint.

Do wyboru czarna lub kamienna szara farba strukturalna.

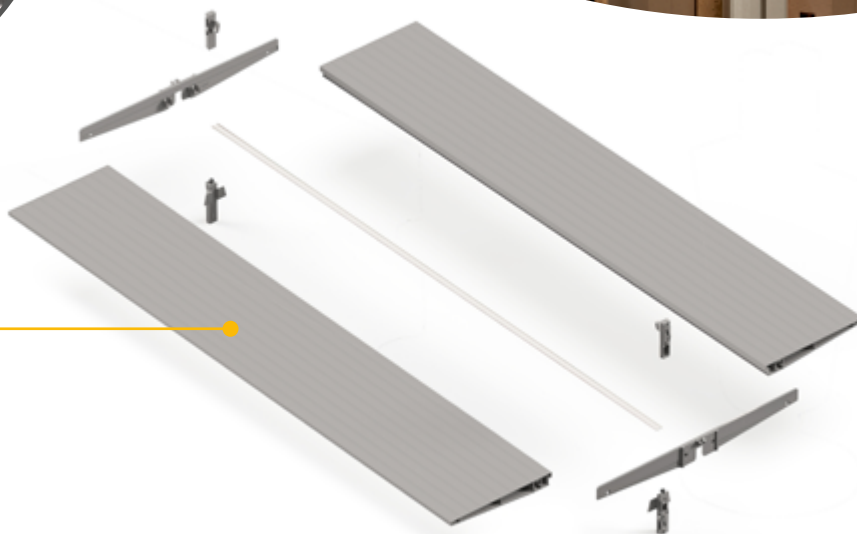
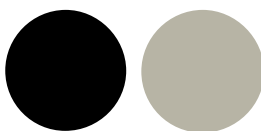

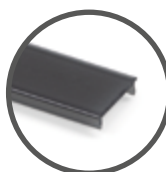
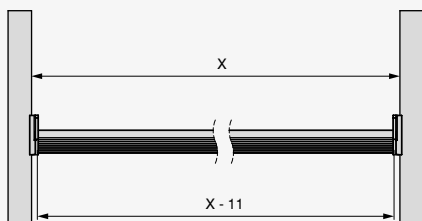

Includes diffuser profile to add LED lighting to the shelf.

Zawiera profil dyfuzora umożliwiający dodanie oświetlenia LED do półki.



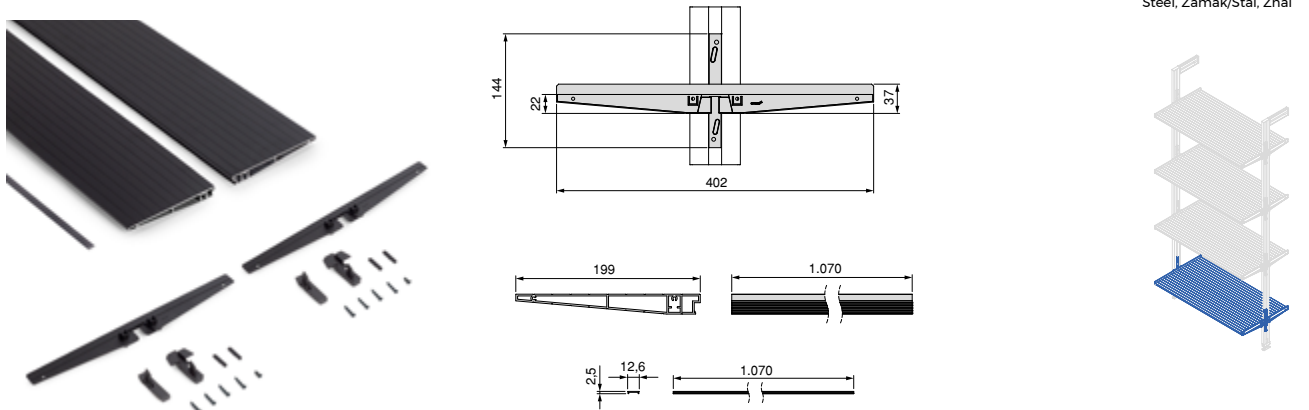

Hardware kit to make an aluminium shelf for the Zero modular structure
Zestaw sprzętu do wykonania półki aluminiowej do konstrukcji modułowej Zero

Finishing/Wykończenie	Packaging/Opakowanie	Cod.
Painted stone grey/Malowany na kolor kamienno-szary 	1 Pair/Kpl.	7023249
Textured black painted/Teksturowana czerń 	1 Pair/Kpl.	7023254



Steel, Zamak/Stal, Znal

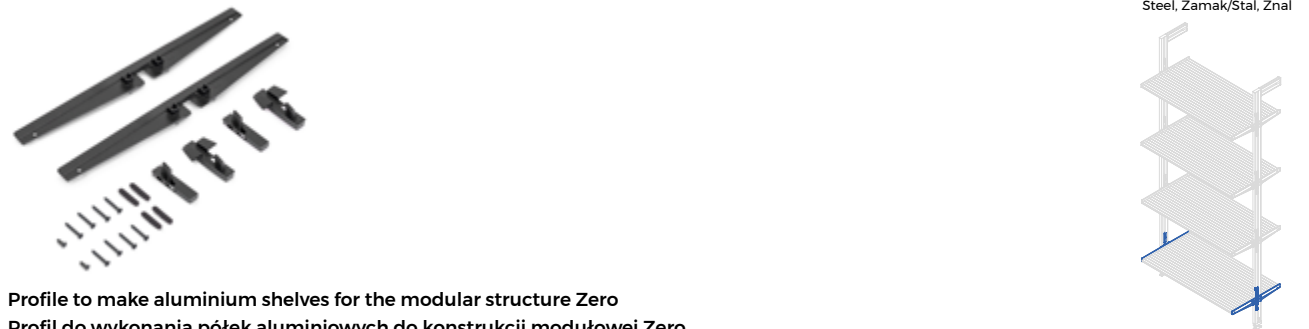

Set of brackets for mounting the aluminium shelf for the Zero modular structure
Zestaw wsporników do montażu półki aluminiowej do konstrukcji modułowej Zero

Finishing/Wykończenie	Packaging/Opakowanie	Cod.
Painted stone grey/Malowany na kolor kamienno-szary 	2 Pair/Kpl.	7033149
Textured black painted/Teksturowana czerń 	2 Pair/Kpl.	7033154



Steel, Zamak/Stal, Znal

Profile to make aluminium shelves for the modular structure Zero
Profil do wykonania półek aluminiowych do konstrukcji modułowej Zero

Longitude/Długość	Finishing/Wykończenie	Packaging/Opakowanie	Cod.
2.160 mm	Painted stone grey/Malowany na kolor kamienno-szary 	4 Unit/Szt	7020949
2.160 mm	Textured black painted/Teksturowana czerń 	4 Unit/Szt	7020954



Aluminium/Aluminium

Luxe rectangular rail Drażek prostokątny Luxe

Set of zamak brackets for a Luxe hanging bar. They are mounted on the profile to create your Zero modular structure.

Zestaw wsporników Zamak do listwy wiszącej Luxe. Są one montowane na profilu, aby stworzyć modułową strukturę Zero.

It has a semi-rigid PVC rubber to avoid the noise of the hangers.

Posiada półsztywną gumę PVC, aby uniknąć hałasu wieszaków.



Choose between black or stone grey textured paint.

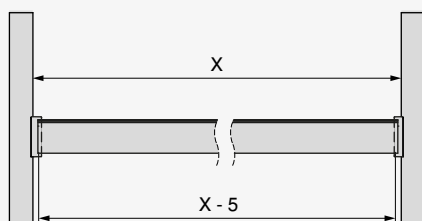
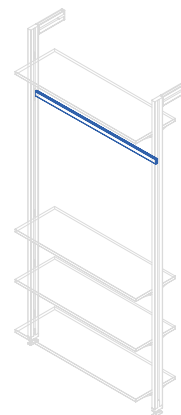

Do wyboru czarna lub kamienna szara farba teksturowana.



Zero support kit for hanging rail

Zestaw wsporników Zero do drążka na wieszaki



Finishing/Wykończenie	Packaging/Opakowanie	Cod.
Painted stone grey/Malowany na kolor kamienno-szary 	8 Pair/Kpl.	7031649
Textured black painted/Teksturowana czerni 	8 Pair/Kpl.	7031654

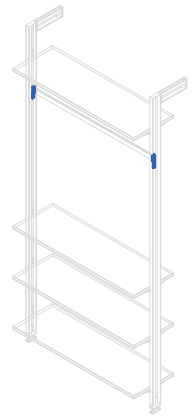
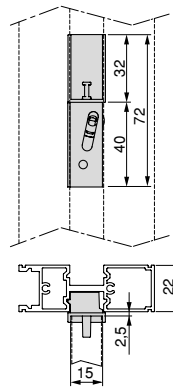

Plastic, Zamak/Plastik, Znal



Luxe rectangular rail for Zero structure

Drążek prostokątny Luxe do struktury Zero



Longitude/Długość	Finishing/Wykończenie	Packaging/Opakowanie	Cod.
1 m	Painted stone grey/Malowany na kolor kamienno-szary 	10 Unit/Szt	7102149
1 m	Textured black painted/Teksturowana czerni 	10 Unit/Szt	7102154

Aluminium/Aluminium

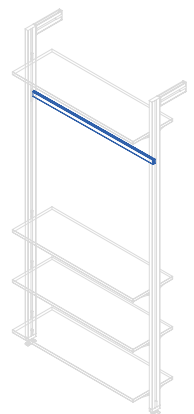
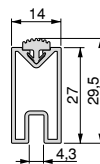
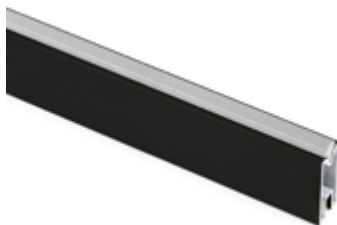

Hang and Hack accessories Akcesoria Hang i Hack

Set of fittings for attaching the Hang folding hanger to the Zero profile.

Zestaw okuć do mocowania składanego wieszaka Hang do profilu Zero.

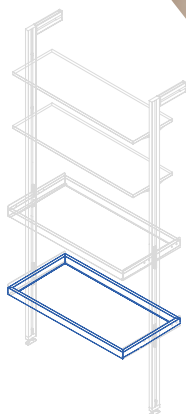
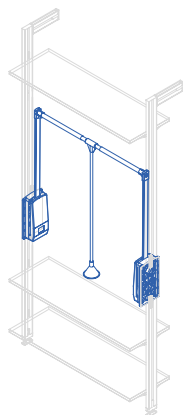

Set of fittings necessary for attaching the Hack frames to the Zero profile.

Zestaw okuć niezbędnych do zamocowania ramek Hack do profilu Zero.

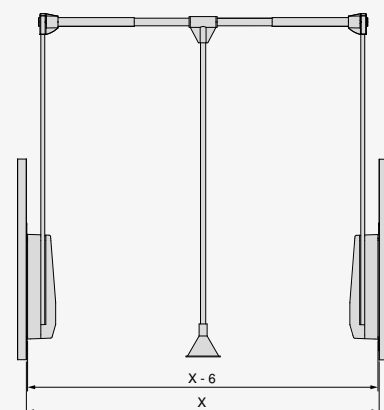

All the accessories for assembly are included.

W zestawie znajdują się wszystkie akcesoria do montażu.

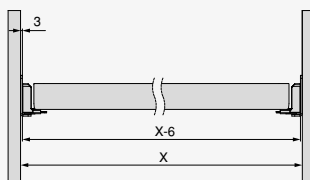

Set of fixings for the Hang folding hanger for the Zero modular structure
Zestaw mocowań do wieszaka składanego Hang do konstrukcji modułowej Zero

Finishing/Wykończenie	Packaging/Opakowanie	Cod.
Textured black painted/Teksturowana czerni 	1 Pair/Kpl.	7022854

Steel, Zamak/Stal, Znal

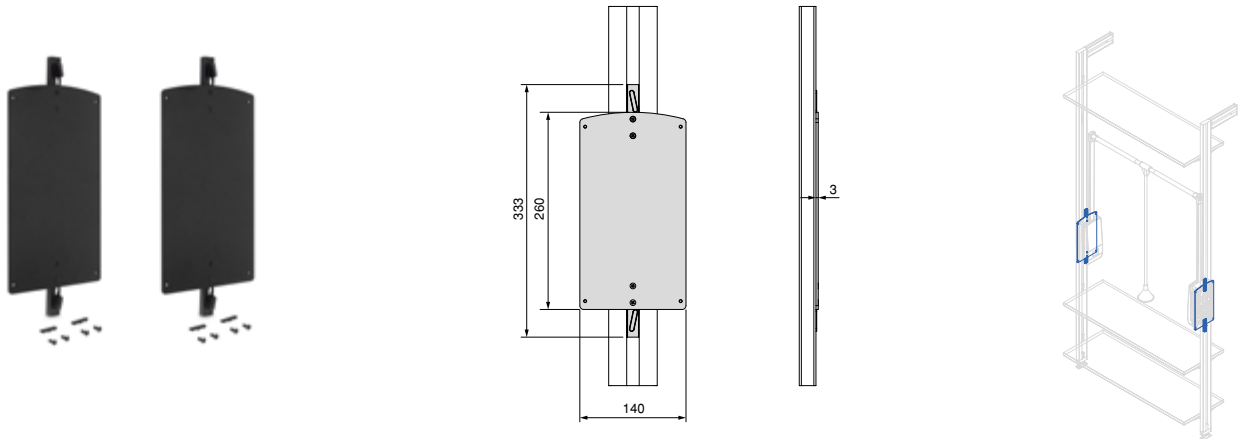

Fixing kit for the Hack cabinet racks for the Zero modular structure
Zestaw mocujący do stojaków szafy Hack dla konstrukcji modułowej Zero

Finishing/Wykończenie	Packaging/Opakowanie	Cod.
Textured black painted/Teksturowana czerni 	2 Pair/Kpl.	7032954

Steel, Zamak/Stal, Znal

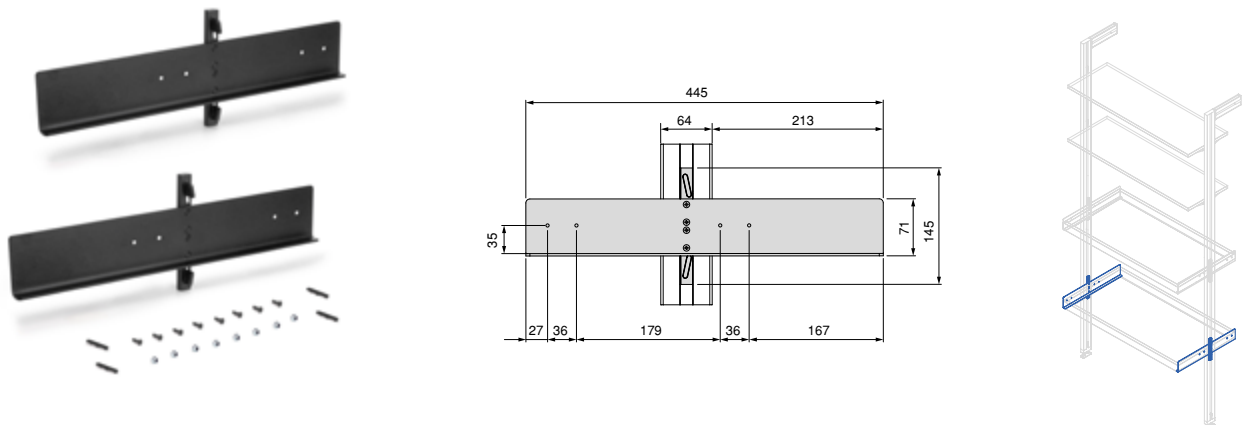

Zero modular structure lighting Oświetlenie struktury modułowej Zero



Rear lighting
Oświetlenie tylne

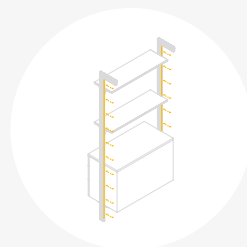
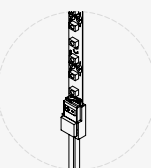
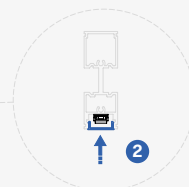
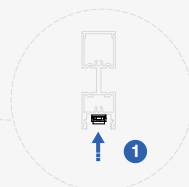
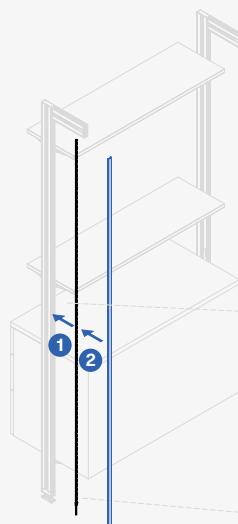

Overhead lighting
Oświetlenie górne

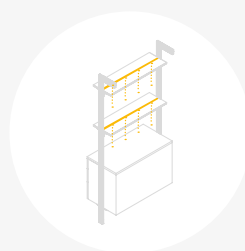
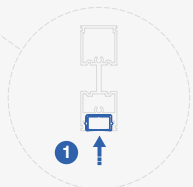
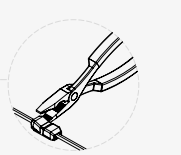
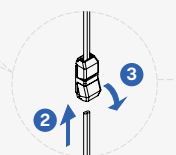
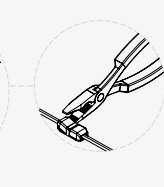
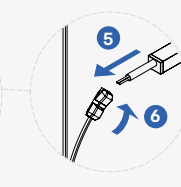
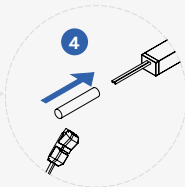
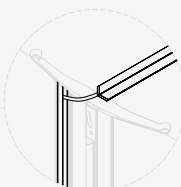
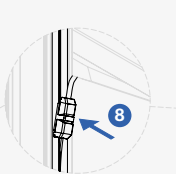
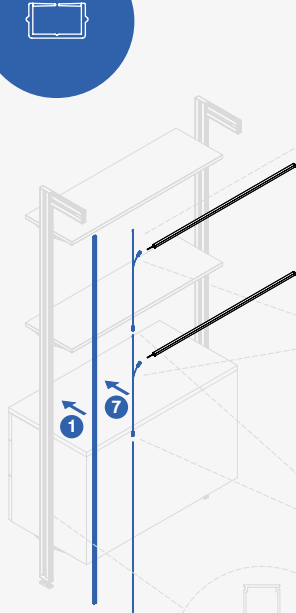



Zero diffuser profile
Profil rozpraszający Zero

Longitude/Długość	Finishing/Wykończenie	Packaging/Opakowanie	Cod.
1,1 m	White plastic/Biały plastik 	20 Unit/Szt	5150315
2,9 m	White plastic/Biały plastik 	20 Unit/Szt	5150415

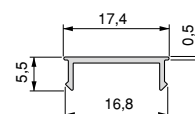
Plastic/Plastik



Zero grommet profile
Profil do przeprowadzania kabli Zero

Longitude/Długość	Finishing/Wykończenie	Packaging/Opakowanie	Cod.
1,1 m	Black plastic/Czarny plastik 	8 Unit/Szt	5150517
2,9 m	Black plastic/Czarny plastik 	8 Unit/Szt	5150617

Plastic/Plastik

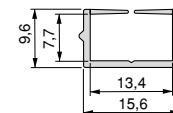

Connector cable for Zero structure lighting
Kabel połączeniowy do oświetlenia struktury Zero

Longitude/Długość	Finishing/Wykończenie	Packaging/Opakowanie	Cod.
500 mm	Not defined/Nieokreślone 	1 KIT/Zestaw	5208320

Plastic/Plastik

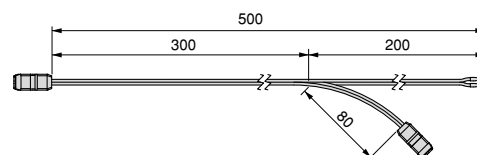

Pull Down Wardrobe Rail Lift Wieszak składany

The folding wardrobe hangers allow effortless access to higher areas. They also have a smooth movement with damped return.

Składane wieszaki do garderoby umożliwiają łatwy dostęp do wyżej położonych miejsc. Mają również płynny ruch z tłumionym powrotem.

12kg

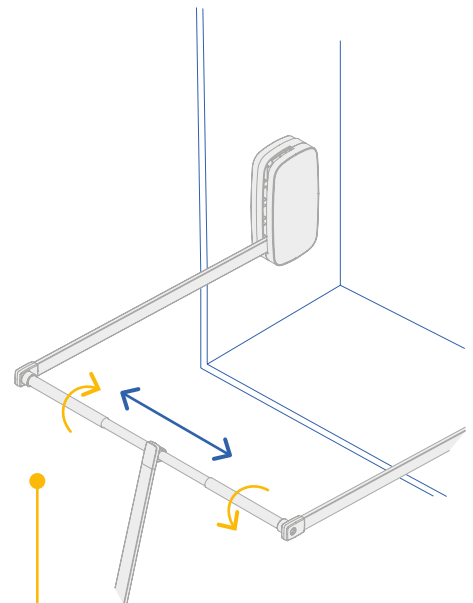

The rod is adjustable in width to be adapted to the useful space of the wardrobe.

Szerokość drążka można regulować w celu dostosowania do przestrzeni użytkowej szafy.



The separator allows the hanger to be installed on the side right at the bottom of the wardrobe.

Separator umożliwia zamontowanie wieszaka z boku na dole szafy.

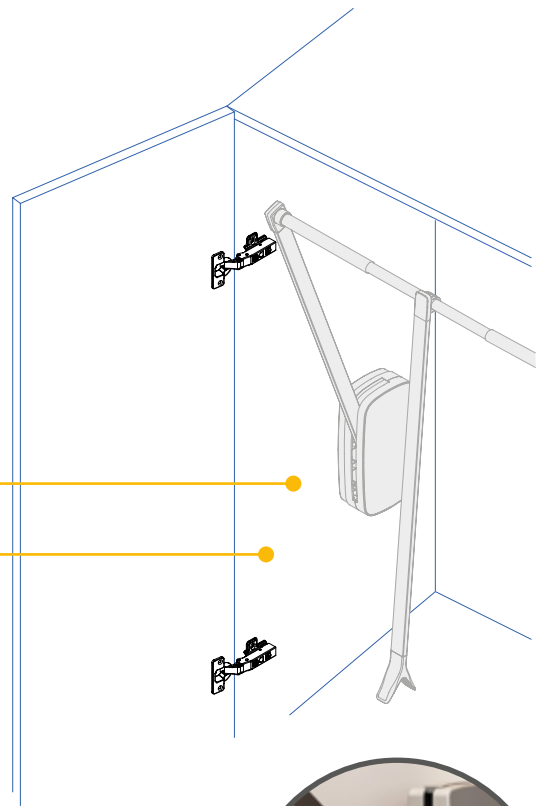

The supplement allows the hanger to be installed in wardrobes with hinged doors.

Dodatek umożliwia montaż wieszaka w szafach z drzwiami skrzydłowymi.

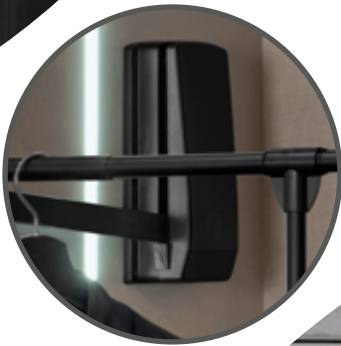

Sling pull down wardrobe rail lift
 Pantograf Sling



Width/Szerokość	Finishing/Wykończenie		Packaging/Opakowanie	Cod.
450 - 600	Chrome plated/Chromowane		1 Unit/Szt	7030011
600 - 830	Chrome plated/Chromowane		1 Unit/Szt	7030111
830 - 1150	Chrome plated/Chromowane		1 Unit/Szt	7030211
450 - 600	White plastic/Biały plastik		1 Unit/Szt	7030015
600 - 830	White plastic/Biały plastik		1 Unit/Szt	7030115
830 - 1150	White plastic/Biały plastik		1 Unit/Szt	7030215
450 - 600	Titanium/Tytanowy		1 Unit/Szt	7030052
600 - 830	Titanium/Tytanowy		1 Unit/Szt	7030152
830 - 1150	Titanium/Tytanowy		1 Unit/Szt	7030252

Plastic, Steel/Plastik, Stal

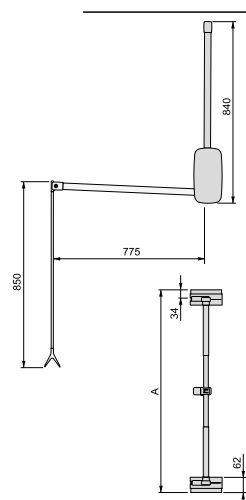
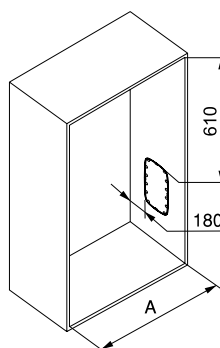

Side covers included to hide the installation screws.
 Also available are cover caps in textile effect.
 Includes mounting screws.
 The handle bar has a fixing system that reduces its swing-back.
 Central bar can be adjusted in width.
 Integrated opening bumper stop.

W komplecie boczne osłony maskujące wkręty montażowe.
 Dostępne są także osłony o powierzchni tekstylnej.
 W komplecie wkręty montażowe.
 Drążek uchwyty jest wyposażony w system mocujący, który ogranicza zakres odchylania się drążka po jego opuszczeniu.
 Szerokość drążka środkowego jest regulowana.
 Zintegrowany odbojnik w otworze na ramiona pantografu.

Set of dividers for Sling pull down wardrobe rail lift
 Zestaw przegródek do podnośnika szynowego do garderoby Sling

Finishing/Wykończenie		Packaging/Opakowanie	Cod.
White plastic/Biały plastik		6 Pair/Kpl.	7030415
Silver painted/Malowane aluminium		6 Pair/Kpl.	7030425
Titanium plastic/Plastik tytanowy		6 Pair/Kpl.	7030438

Plastic/Plastik

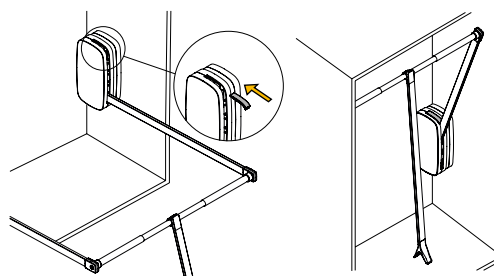

Allows Sling to be mounted to the back of the wardrobe.

Możliwość montowania drążka opuszczanego Sling do tylnej części szafy.

Side supplement for Sling pull down wardrobe rail lift
 Wkładka boczna do pantografu Sling



Finishing/Wykończenie		Packaging/Opakowanie	Cod.
White plastic/Biały plastik		1 Pair/Kpl.	7067315
Silver painted/Malowane aluminium		1 Pair/Kpl.	7067325
Titanium plastic/Plastik tytanowy		1 Pair/Kpl.	7067338

Plastic/Plastik

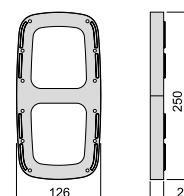
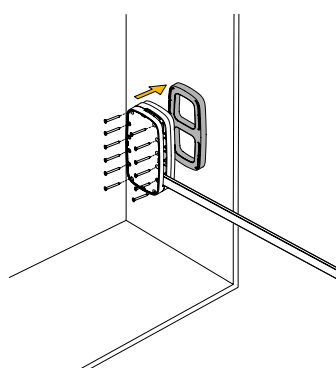

Hang pull down wardrobe rail lift
 Pantograf Hang



Width/Szerokość	Finishing/Wykończenie	Packaging/Opakowanie	Cod.
450 - 600	Painted stone grey/Malowany na kolor kamienno-szary	1 Unit/Szt	9283749
600 - 830	Painted stone grey/Malowany na kolor kamienno-szary	1 Unit/Szt	9283849
830 - 1150	Painted stone grey/Malowany na kolor kamienno-szary	1 Unit/Szt	9283949
450 - 600	Chrome plated/Chromowane	1 Unit/Szt	9283711
600 - 830	Chrome plated/Chromowane	1 Unit/Szt	9283811
830 - 1150	Chrome plated/Chromowane	1 Unit/Szt	9283911
450 - 600	Moka painted/Malowane na kolor mokka	1 Unit/Szt	9283713
600 - 830	Moka painted/Malowane na kolor mokka	1 Unit/Szt	9283813
830 - 1150	Moka painted/Malowane na kolor mokka	1 Unit/Szt	9283913
450 - 600	Black painted/Malowane na czarno	1 Unit/Szt	9283714
600 - 830	Black painted/Malowane na czarno	1 Unit/Szt	9283814
830 - 1150	Black painted/Malowane na czarno	1 Unit/Szt	9283914

Plastic, Steel/Plastik, Stal

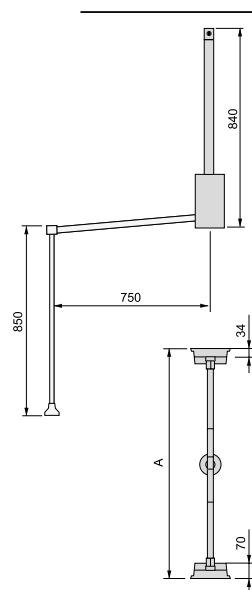
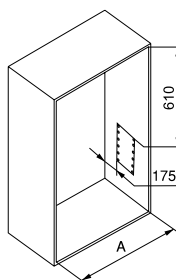

Set of dividers for Hang pull down wardrobe rail lift
 Zestaw przegródek do podnośnika szynowego do garderoby Hang

Finishing/Wykończenie	Packaging/Opakowanie	Cod.
Silver painted/Malowane aluminium	6 Pair/Kpl.	8285425

Plastic/Plastik

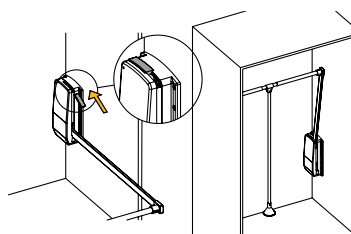

Side supplement for Hang pull down wardrobe rail lift
 Wkładka boczna do pantografu Hang

Finishing/Wykończenie		Packaging/Opakowanie	Cod.
Painted stone grey/Malowany na kolor kamienno-szary		1 Pair/Kpl.	7085049
Silver painted/Malowane aluminium		1 Pair/Kpl.	7085025
Moka painted/Malowane na kolor mokka		1 Pair/Kpl.	7085013
Black plastic/Czarny plastik		1 Pair/Kpl.	7085017

Plastic/Plastik

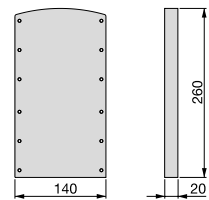

Hang pull down wardrobe rail lift wall-mounted
 System Hang mocowany do ściany



Width/Szerokość	Finishing/Wykończenie	Packaging/Opakowanie	Cod.
600-830	Chrome plated/Chromowane	1 Unit/Szt	6037811

Plastic, Steel/Plastik, Stal

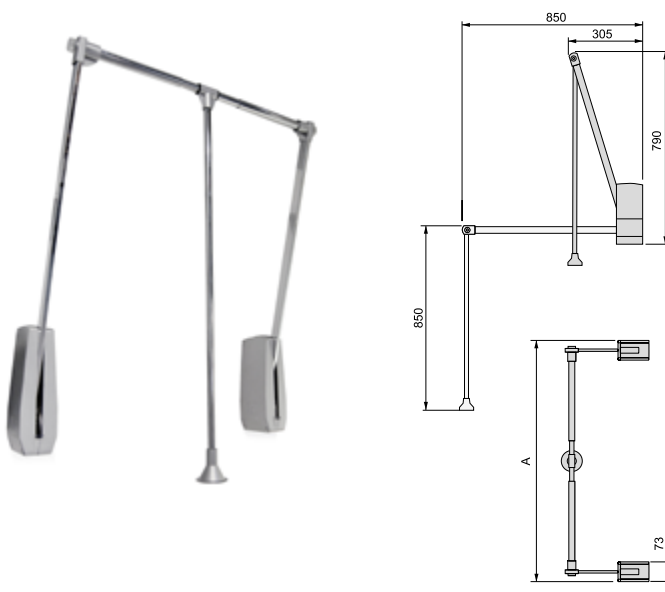

Wardrobe interior wardrobe rails Drażki na wieszaki

Essential for wardrobe and dressing room design.

Niezbędny do projektowania szaf i garderób.

KITS

It has a semi-rigid PVC rubber to prevent noise from the hangers.



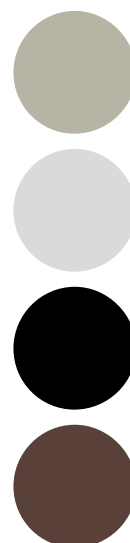

Posiada półsztywną gumę PVC, aby zapobiec hałasowi z wieszaków.

Choose between stone grey, matt anodised, textured black and mocha.

Do wyboru w kolorze szarym kamiennym, matowym anodowanym, czarnym teksturowanym i mokka.



Luxe rectangular wardrobe rail kit
Drażek kwadratowy do szafy Luxe



Longitude/Długość	Finishing/Wykończenie	Packaging/Opakowanie	Cod.
2.35 m	Painted stone grey/Malowany na kolor kamienno-szary 	10 Unit/Szt	7100849
2.35 m	Matt anodized/Anodyzowany mat 	10 Unit/Szt	7100862
2.35 m	Textured black painted/Teksturowana czerni 	10 Unit/Szt	7100854
2.35 m	Moka painted/Malowane na kolor mokka 	10 Unit/Szt	7100813

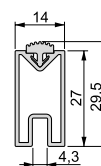
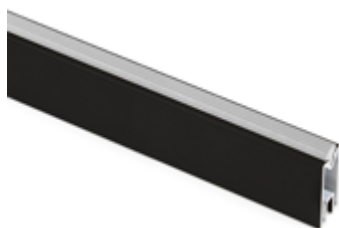

Aluminium/Aluminium

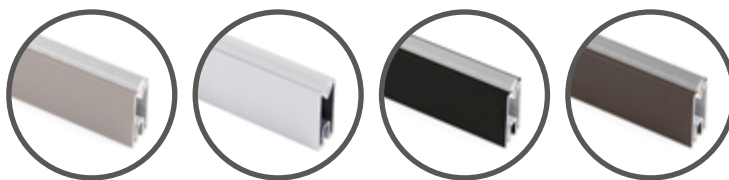

With semi-hard P.V.C profile to avoid coathanger noise and scratches.

Z półtwardym profilem P.V.C, aby uniknąć hałasu i zarysowań powłoki.

Silk wardrobe rail kit
Drażek do szafy Silk

Longitude/Długość	Finishing/Wykończenie	Packaging/Opakowanie	Cod.
2.35 m	Black painted/Malowane na czarno 	10 Unit/Szt	6072114
2.35 m	Matt anodized/Anodyzowany mat 	10 Unit/Szt	6072162

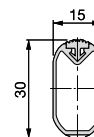
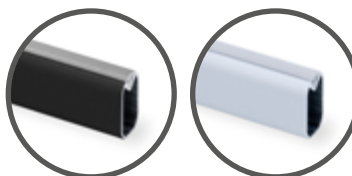

Aluminium/Aluminium



With semi-hard P.V.C profile to avoid coathanger noise and scratches.

Z półtwardym profilem P.V.C, aby uniknąć hałasu i zarysowań powłoki.



Ø28 round wardrobe rail
Okrągły drążek do szafy Ø28

Longitude/Długość	Finishing/Wykończenie	Packaging/Opakowanie	Cod.
2,35 m	Moka painted/Malowane na kolor mokka 	10 Unit/Szt	6057813
2,35 m	Black painted/Malowane na czarno 	10 Unit/Szt	6057814
2,35 m	Matt anodized/Anodyzowany mat 	10 Unit/Szt	6057862

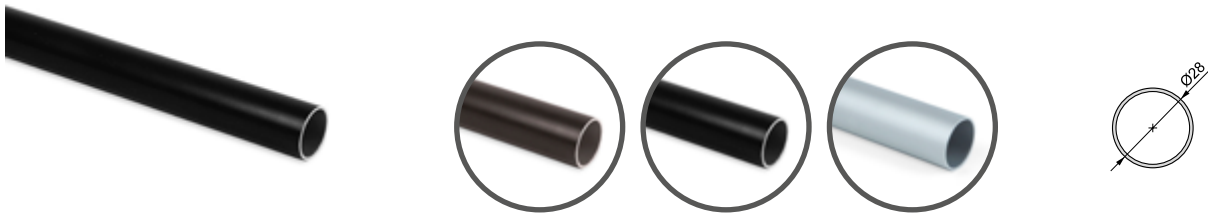
Aluminium/Aluminium



Aluminium wardrobe rail
Aluminiowy drążek do szafy

Longitude/Długość	Finishing/Wykończenie	Packaging/Opakowanie	Cod.
2,35 m	Matt anodized/Anodyzowany mat 	15 Unit/Szt	6220362
3,9 m	Matt anodized/Anodyzowany mat 	15 Unit/Szt	6220262

Aluminium/Aluminium





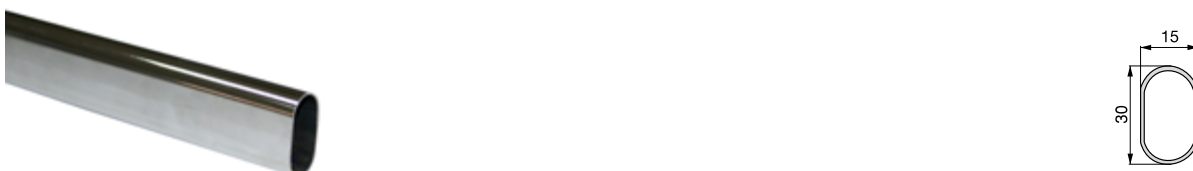

Steel wardrobe rail
Stalowy drążek do szafy

Longitude/Długość	Finishing/Wykończenie	Packaging/Opakowanie	Cod.
2,35 m	Chrome plated/Chromowane 	10 Unit/Szt	7009411

Steel/Stal



Wardrobe hanging rail kit Luxe
Zestaw drążków Luxe

Longitude/Długość	Finishing/Wykończenie	Packaging/Opakowanie	Cod.
1,15 m	Painted stone grey/Malowany na kolor kamienno-szary 	1 KIT/Zestaw	7101349
0,75 m	Painted stone grey/Malowany na kolor kamienno-szary 	1 KIT/Zestaw	7101449
1,15 m	Textured black painted/Teksturowana czerni 	1 KIT/Zestaw	7101354
0,75 m	Textured black painted/Teksturowana czerni 	1 KIT/Zestaw	7101454

Aluminium, Plastic/Aluminium, Plastik



KITS

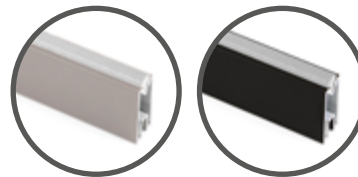
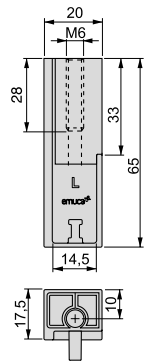
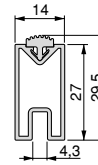

The kit includes everything needed to mount two wardrobe bars Luxe: the tube, the lateral supports, the assembly M6 screws. The tube has a piece of PVC rubber co-extruded in order to avoid noise when moving the hangers. The 1150 mm kits also include 2 central supports to provide the assembly with greater rigidity.



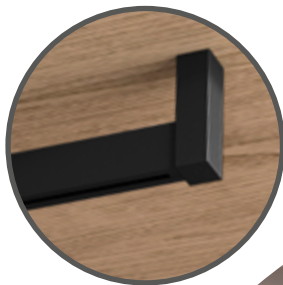

Zestaw zawiera wszystko, co jest potrzebne do montażu dwóch prętów do szafy Luxe: rurki, wspornik boczne i śruby M6 do montażu.

Rurka posiada współwytłaczaną gumę z PVC, aby wytłumić hałas wieszaków.

Zestawy 1150mm posiadają również 2 wsporniki centralne, aby zapewnić większą sztywność montażu.



Wardrobe hanging rail kit Silk
Zestaw drążków Silk

Longitude/Długość	Finishing/Wykończenie		Packaging/Opakowanie	Cod.
1,15 m	Black painted/Malowane na czarno		1 KIT/Zestaw	7070014
0,75 m	Black painted/Malowane na czarno		1 KIT/Zestaw	7070114
1,15 m	Matt anodized/Anodowany mat		1 KIT/Zestaw	7070062
0,75 m	Matt anodized/Anodowany mat		1 KIT/Zestaw	7070162

Aluminium, Plastic/Aluminium, Plastik

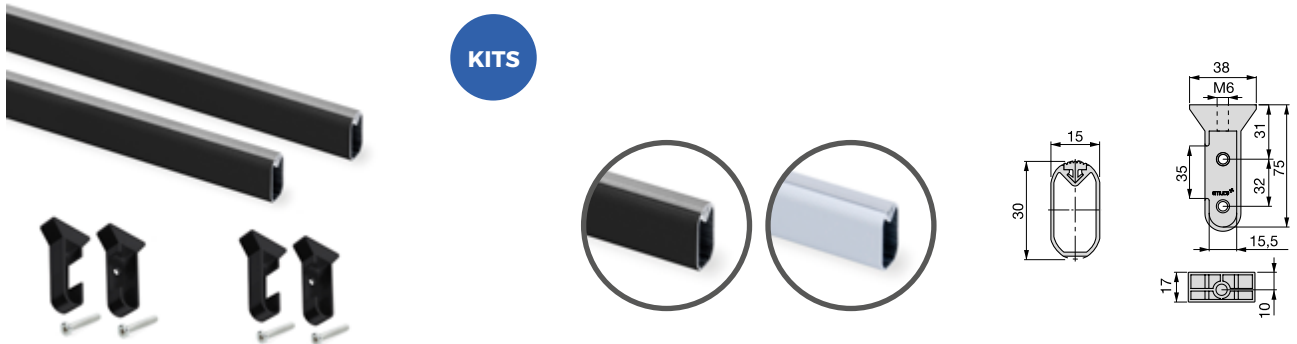

The kit includes everything needed to mount two 30x15 mm wardrobe bars Silk: the tube, the lateral supports, the assembly M6 screws.

The tube has a piece of PVC rubber co-extruded in order to avoid noise when moving the hangers.



The 1150 mm kits also include 2 central supports to provide the assembly with greater rigidity.

Zestaw zawiera wszystko, co jest potrzebne do montażu dwóch prętów do szafy Silk 30x15 mm: rurki, wspornik boczny i śruby M6 do montażu.

Rurka posiada współwyłaczaną gumę z PVC, aby wytłumić hałas wieszaków.

Zestawy 1150mm posiadają również 2 wsporniki centralne, aby zapewnić większą sztywność montażu.

Wardrobe hanging rail kit 30x15 mm aluminium
Zestaw drążków 30x15 mm aluminium

Longitude/Długość	Finishing/Wykończenie		Packaging/Opakowanie	Cod.
0,75 m	Matt anodized/Anodowany mat		1 KIT/Zestaw	7070362
1,15 m	Matt anodized/Anodowany mat		1 KIT/Zestaw	7070262

Aluminium, Zamak/Aluminium, Znak

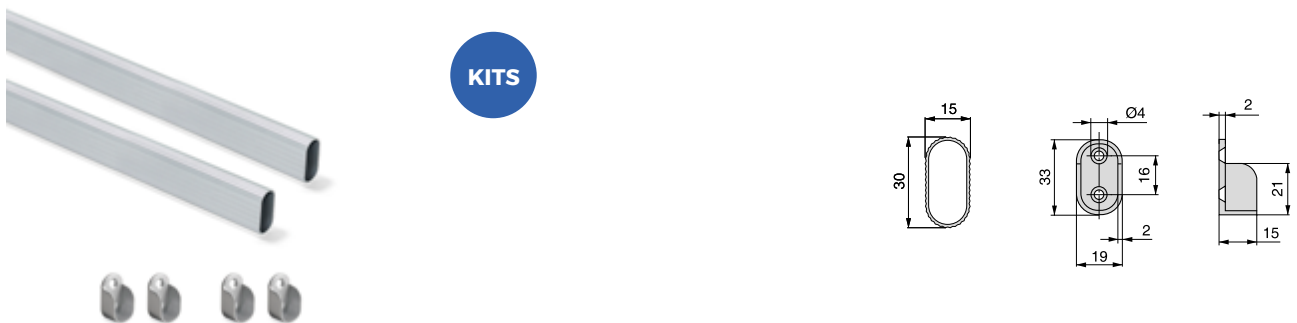

The kit includes two 30x15 mm wardrobe bars made from aluminium and the lateral supports for their installation. The 1150 mm kits also include 2 central supports to provide the assembly with greater rigidity.

Zestaw zawiera dwa drążki do szafy 30x15 mm wykonane ze aluminium oraz wsporniki boczne do montażu.

W zestawach 1150 mm znajdują się również 2 wsporniki środkowe, aby zapewnić większą sztywność całości.

Wardrobe hanging rail kit 30x15 mm steel
Zestaw drążków 30x15 mm stal

Longitude/Długość	Finishing/Wykończenie	Packaging/Opakowanie	Cod.
0,75 m	Chrome plated/Chromowane	1 KIT/Zestaw	7070511
1,15 m	Chrome plated/Chromowane	1 KIT/Zestaw	7070411

Steel, Zamak/Stal, Znal



The kit includes two 30x15 mm wardrobe bars made from steel and the lateral supports for their installation.
The 1150 mm kits also include 2 central supports to provide the assembly with greater rigidity.

Zestaw zawiera dwa drążki do szafy 30x15 mm wykonane ze stali oraz wsporniki boczne do montażu.
W zestawach 1150 mm znajdują się również 2 wsporniki środkowe, aby zapewnić większą sztywność całości.

Wardrobe hanging rail kit round Ø28
Zestaw drążków okrągłych średnica Ø28

Longitude/Długość	Finishing/Wykończenie	Packaging/Opakowanie	Cod.
0,75 m	Moka painted/Malowane na kolor mokka	1 KIT/Zestaw	7070713
1,15 m	Moka painted/Malowane na kolor mokka	1 KIT/Zestaw	7070613
0,75 m	Black painted/Malowane na czarno	1 KIT/Zestaw	7070714
1,15 m	Black painted/Malowane na czarno	1 KIT/Zestaw	7070614
0,75 m	Matt anodized/Anodyzowany mat	1 KIT/Zestaw	7070762
1,15 m	Matt anodized/Anodyzowany mat	1 KIT/Zestaw	7070662

Aluminium, Zamak/Aluminium, Znal



The kit includes everything needed to mount two D.28 mm wardrobe bars: the tube, the lateral supports, the assembly screws.
The 1150 mm kits also include 2 central supports to provide the assembly with greater rigidity.

Zestaw zawiera wszystko, co potrzebne do montażu dwóch prętów do szafy o średnicy 28 mm: rurkę, wsporniki boczne i śruby do montażu.
Zestawy 1150 mm zawierają również 2 wsporniki centralne, aby zapewnić większą sztywność montażu.



Luxe wardrobe rail support set
Zestaw uchwytów do szafy Luxe

Finishing/Wykończenie	Packaging/Opakowanie	Cod.
Painted stone grey/Malowany na kolor kamienno-szary	10 Pair/Kpl.	7102049
Silver painted/Malowane aluminium	10 Pair/Kpl.	7102025
Moka painted/Malowane na kolor mokka	10 Pair/Kpl.	7102013
Textured black painted/Teksturowana czerni	10 Pair/Kpl.	7102054



To calculate the measurement of the bar, subtract 10 mm from the inter-axis of the end support.

W celu obliczenia wymiaru drążka, od rozstawu osi wspornika należy odjąć 10 mm.

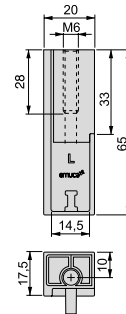

Zamak/Znal

Luxe wardrobe rail central support
Środkowy uchwyt drążka do szafy Luxe

Finishing/Wykończenie	Packaging/Opakowanie	Cod.
Painted stone grey/Malowany na kolor kamienno-szary	20 Unit/Szt	7100349
Silver painted/Malowane aluminium	20 Unit/Szt	7100325
Moka painted/Malowane na kolor mokka	20 Unit/Szt	7100313
Textured black painted/Teksturowana czerni	20 Unit/Szt	7100354

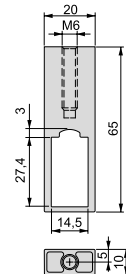

Zamak/Znal

Luxe wardrobe rail angular support
Uchwyt kątowy drążka do szafy

Finishing/Wykończenie	Packaging/Opakowanie	Cod.
Moka painted/Malowane na kolor mokka	20 Unit/Szt	7100213
Silver painted/Malowane aluminium	20 Unit/Szt	7100225
Textured black painted/Teksturowana czerni	20 Unit/Szt	7100254

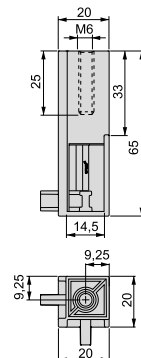
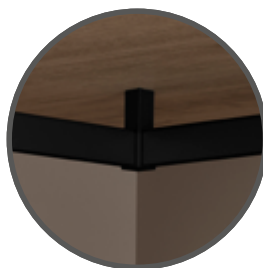

Zamak/Znal

Luxe wardrobe rail support
Uchwyt do drążka do szafy Luxe



Finishing/Wykończenie		Packaging/Opakowanie	Cod.
Moka painted/Malowane na kolor mokka		20 JG/JG	7101543
Black painted/Malowane na czarno		20 JG/JG	7101554
Silver painted/Malowane aluminium		20 JG/JG	7101525

Plastic/Plastik



To calculate the measurement of the rail subtract 11 mm from the internal width.

Aby obliczyć wymiar szyny, od wewnętrznej szerokości należy odjąć 11 mm.

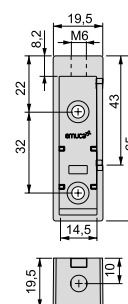

Ø28 wardrobe rail support set
Zestaw uchwytów do drążka do szafy Ø28

Finishing/Wykończenie		Packaging/Opakowanie	Cod.
Moka painted/Malowane na kolor mokka		10 Pair/Kpl.	7922513
Black painted/Malowane na czarno		10 Pair/Kpl.	7922514
Silver painted/Malowane aluminium		10 Pair/Kpl.	7922525

Zamak/Znal



To calculate the measurement of the bar, subtract 3 mm from the inter-axis of the end support.

W celu obliczenia wymiaru drążka, od rozstawu osi wspornika należy odjąć 3 mm.

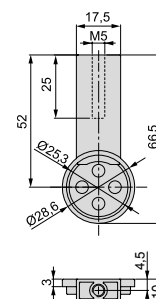



Ø28 wardrobe rail central support
Środkowy uchwyt drążka do szafy Ø28

Finishing/Wykończenie		Packaging/Opakowanie	Cod.
Moka painted/Malowane na kolor mokka		20 Unit/Szt	7919713
Black painted/Malowane na czarno		20 Unit/Szt	7919714
Silver painted/Malowane aluminium		20 Unit/Szt	7919725

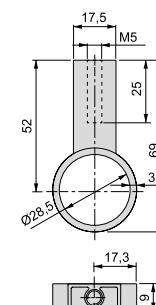
Zamak/Znal



Ø28 wardrobe rail lateral support
Boczny uchwyt drążka do szafy Ø28

Finishing/Wykończenie	Packaging/Opakowanie	Cod.
Moka plastic/Plastik w kolorze mokka 	50 Unit/Szt	7919843
Grey plastic/Szary plastik 	50 Unit/Szt	7919821
Black plastic/Czarny plastik 	50 Unit/Szt	7919817

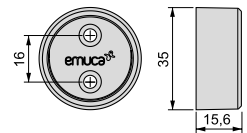

Plastic, Zamak/Plastik, Znal



To calculate the measurement of the rail subtract 6 mm from the internal width.

W celu obliczenia wymiaru drążka, należy odjąć 6 mm od i wyposażonej szerokości.



Silk wardrobe rail central support
Środkowy uchwyt drążka do szafy Silk

Finishing/Wykończenie	Packaging/Opakowanie	Cod.
Black painted/Malowane na czarno 	20 Unit/Szt	6003114
Silver painted/Malowane aluminium 	20 Unit/Szt	6003125

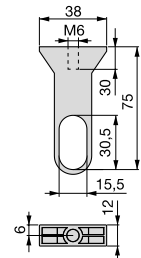
Plastic/Plastik



Silk wardrobe rail support set
Zestaw uchwytów do drążka do szafy Silk

Finishing/Wykończenie	Packaging/Opakowanie	Cod.
Black painted/Malowane na czarno 	10 Pair/Kpl.	7101014
Silver painted/Malowane aluminium 	10 Pair/Kpl.	7101025

Plastic/Plastik

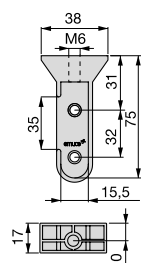

To calculate the measurement of the rail subtract 7 mm from the internal width.

W celu obliczenia wymiaru drążka, należy odjąć 7 mm od i wyposażonej szerokości.

Silk wardrobe rail angular support
Uchwyt kątowy drążka do szafy Silk

Finishing/Wykończenie	Packaging/Opakowanie	Cod.
Black painted/Malowane na czarno	20 Unit/Szt	6003214
Silver painted/Malowane aluminium	20 Unit/Szt	6003225

Plastic/Plastik

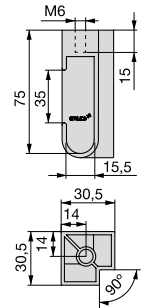
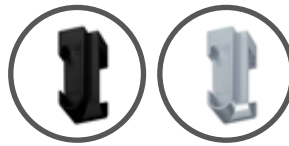

Wardrobe rail lateral support 90168
Boczny uchwyt drążka do szafy 90168

Finishing/Wykończenie	Packaging/Opakowanie	Cod.
Nickel plated/Niklowane	500 Unit/Szt	9016807
Silver painted/Malowane aluminium	500 Unit/Szt	9016825

Zamak/Znal

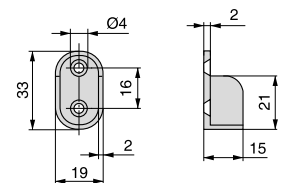

Direct assembly wardrobe rail lateral support
Boczny uchwyt do drążka do szafy, montaż bezpośredni

Finishing/Wykończenie	Packaging/Opakowanie	Cod.
Nickel plated/Niklowane	500 Unit/Szt	9016707

Zamak/Znal

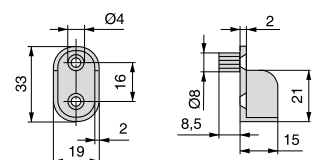

Wardrobe rail lateral support 40070
Boczny uchwyt drążka do szafy 40070

Finishing/Wykończenie	Packaging/Opakowanie	Cod.
Nickel plated/Niklowane 	500 Unit/Szt	4007007

Steel/Stal

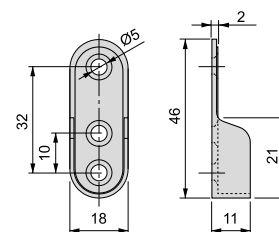



Wardrobe rail lateral support 70143
Boczny uchwyt drążka do szafy 70143

Finishing/Wykończenie	Packaging/Opakowanie	Cod.
Nickel plated/Niklowane 	500 Unit/Szt	7014307

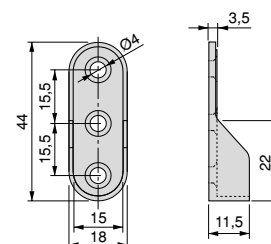
Zamak/Znal





Wardrobe rail lateral support 60474
Boczny uchwyt drążka do szafy 60474

Finishing/Wykończenie	Packaging/Opakowanie	Cod.
Nickel plated/Niklowane 	200 Unit/Szt	6047407
Silver painted/Malowane aluminium 	200 Unit/Szt	6047425

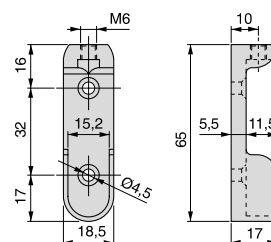
Zamak/Znal



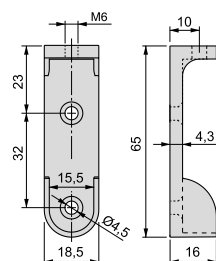

Wardrobe rail lateral support 71468
Boczny uchwyt drążka do szafy 71468

Finishing/Wykończenie	Packaging/Opakowanie	Cod.
Nickel plated/Niklowane 	250 Unit/Szt	7146807
Silver painted/Malowane aluminium 	250 Unit/Szt	7146825



Zamak/Znal

Wardrobe rail lateral support 60026
Boczny uchwyt drążka do szafy 60026

Finishing/Wykończenie	Packaging/Opakowanie	Cod.
Nickel plated/Niklowane 	300 Unit/Szt	6002607
Silver painted/Malowane aluminium 	300 Unit/Szt	6002625

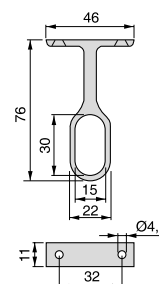

Zamak/Znal

Wardrobe rail central support 81203
Środkowy uchwyt drążka do szafy 81203

L	Finishing/Wykończenie	Packaging/Opakowanie	Cod.
30	Silver painted/Malowane aluminium 	500 Unit/Szt	8120325

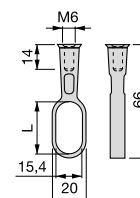

Zamak/Znal

Wall coat racks Wieszak ścienny

The wall hooks are sturdy and are easy to attach to the wall with screws included in the scope of delivery.

Haki ścienne są solidne i można je łatwo przymocować do ściany za pomocą śrub wchodzących w zakres dostawy.

KITS



This coat rack folds down to hang items and folds flat to save space.

Ten wieszak na płaszczce składa się, aby powiesić rzeczy i składa się na płasko, aby zaoszczędzić miejsce.



It has an anti-slip rubber in the hanging area for better grip.

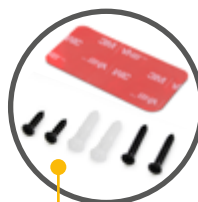

Posiada antypoślizgową gumę w obszarze zawieszenia dla lepszej przyczepności.



It offers three types of installation, screwed to the wall, screwed to a piece of furniture or glued.

Oferuje trzy rodzaje montażu: przykręcany do ściany, przykręcany do mebla lub przyklejany.



Wellington wall hanger
Wieszak ścienny Wellington

Finishing/Wykończenie	Packaging/Opakowanie	N° pieces/Liczba elementów	Cod.
Chrome plated/Chromowane 	1 Unit/Szt	7 units/7 jednostki	7200211
Black painted/Malowane na czarno 	1 Unit/Szt	7 units/7 jednostki	7200214

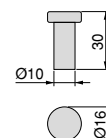
Zamak/Znal





Hamilton wall hanger
Wieszak ścienny Hamilton

Finishing/Wykończenie	Packaging/Opakowanie	Cod.
Black painted/Malowane na czarno 	1 Unit/Szt	7200314
Satin finished nickel/Nikiel satynowy 	1 Unit/Szt	7200351

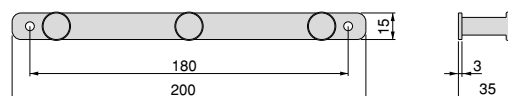
Steel/Stal



Nelson wall hanger
Wieszak ścienny Nelson

Finishing/Wykończenie	Packaging/Opakowanie	N° pieces/Liczba elementów	Cod.
Black painted/Malowane na czarno 	1 LOT/Partia	4 units/4 jednostki	7200114
Matt anodized/Anodyzowany mat 	1 LOT/Partia	4 units/4 jednostki	7200162

Aluminium/Aluminium

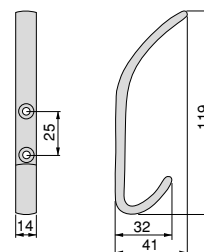

Folding wall hanger
Składany wieszak ścienny

Finishing/Wykończenie	Packaging/Opakowanie	N° pieces/Liczba elementów	Cod.
Black painted/Malowane na czarno 	1 Unit/Szt	5 units/5 jednostki	7200414

Steel/Stal

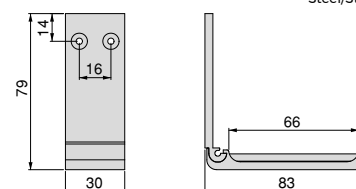

Hack accessories Akcesoria Hack

Hack enclosure accessories are distinguished by their elegant design and flawless finish, which is achieved by mechanical assembly.

Akcesoria do obudów Hack wyróżniają się eleganckim wzornictwem i nieskazitelnym wykończeniem, które uzyskuje się poprzez montaż mechaniczny.

20kg

slow

partial

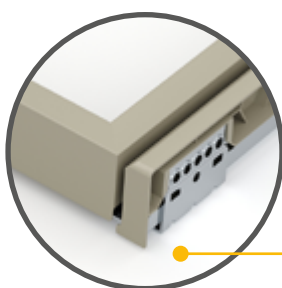
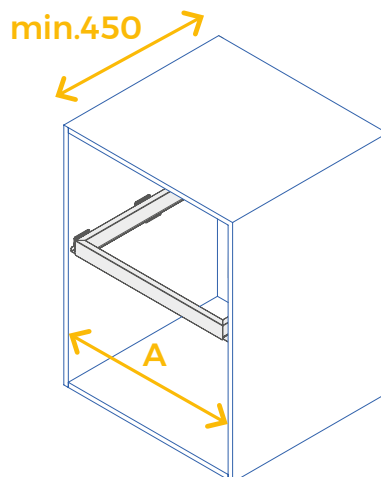

It has a range of cabinet openings from 560 to 1,112 mm (A) wide to be able to install the racks.

Posiada szereg otworów w szafach o szerokości od 560 do 1112 mm (A), umożliwiających montaż szaf rack.

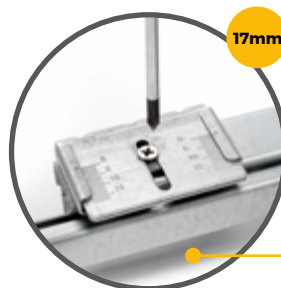

17mm

It has an adjustment of up to 17mm in each of its guides.

Posiada regulację do 17 mm w każdej z prowadnic.



The spacer leaves a space of 25mm between the frame and the side of the cabinet.

Element dystansowy pozostawia przestrzeń 25 mm między ramą a bokiem szafy.

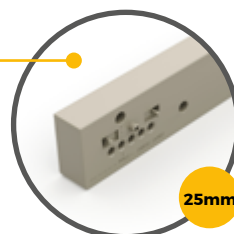

25mm



Choose between black or stone grey textured paint.

Do wyboru czarna lub kamienna szara farba strukturalna.



Hack



Hack accessories Akcesoria Hack

Hack enclosure accessories are distinguished by their elegant design and flawless finish, which is achieved by mechanical assembly.

Akcesoria do obudów Hack wyróżniają się eleganckim wzornictwem i nieskazitelnym wykończeniem, które uzyskuje się poprzez montaż mechaniczny.

20kg

slow

partial

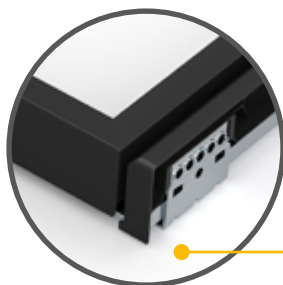
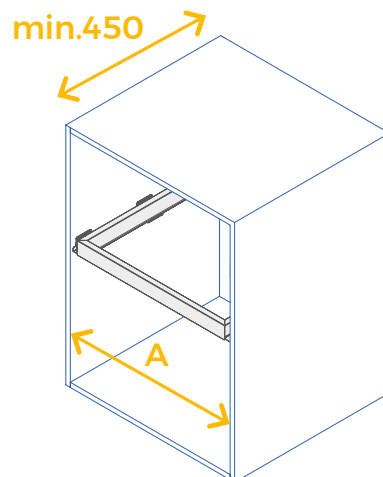

It has a range of cabinet openings from 560 to 1,112 mm (A) wide to be able to install the racks.

Posiada szereg otworów w szafach o szerokości od 560 do 1112 mm (A), umożliwiających montaż szaf rack.

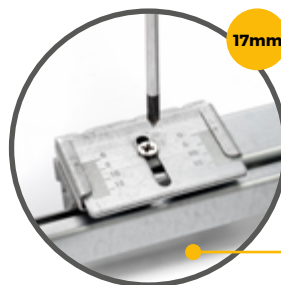

It has an adjustment of up to 17mm in each of its guides.

Posiada regulację do 17 mm w każdej z prowadnic.



The spacer leaves a space of 25mm between the frame and the side of the cabinet.

Element dystansowy pozostawia przestrzeń 25 mm między ramą a bokiem szafy.

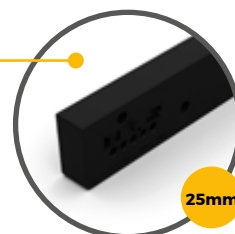

Choose between black or stone grey textured paint.

Do wyboru czarna lub kamienna szara farba teksturowana.

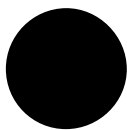

Hack











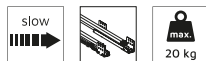













Hack accessories
Akcesoria Hack



Frame with soft-close slides for cabinet accessories Hack

Rama z szynami z systemem Soft-Close dla akcesoriów szafek Hack







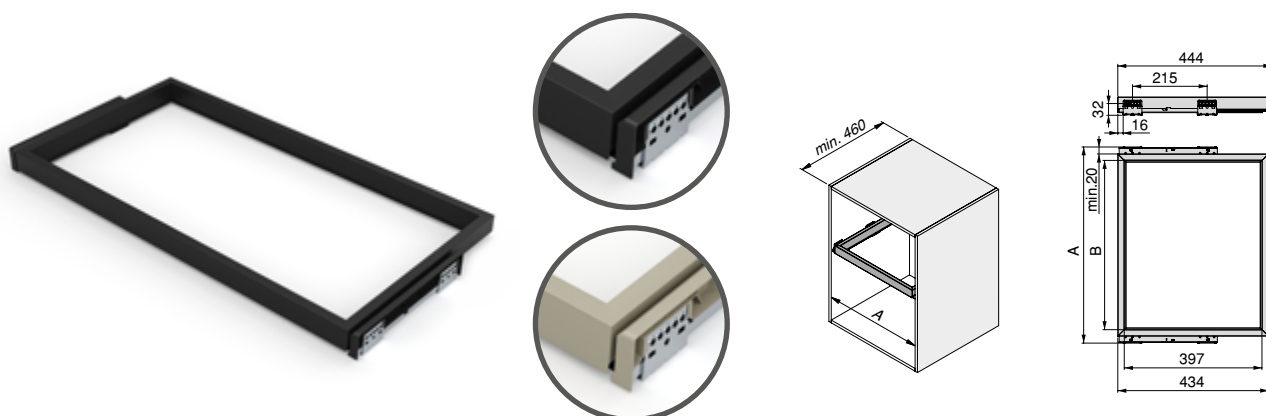

A	B	Finishing/Wykończenie	Packaging/Opakowanie	Cod.
560 - 594	483 (M60)	Textured black painted/Teksturowana czerń 	2 Unit/Szt	7113054
623 - 657	546	Textured black painted/Teksturowana czerń 	2 Unit/Szt	7113154
682 - 716	605	Textured black painted/Teksturowana czerń 	2 Unit/Szt	7113254
741 - 775	664	Textured black painted/Teksturowana czerń 	2 Unit/Szt	7113354
760 - 794	683 (M80)	Textured black painted/Teksturowana czerń 	2 Unit/Szt	7113454
798 - 832	721	Textured black painted/Teksturowana czerń 	2 Unit/Szt	7113554
832 - 866	755	Textured black painted/Teksturowana czerń 	2 Unit/Szt	7113654
860 - 894	783 (M90)	Textured black painted/Teksturowana czerń 	2 Unit/Szt	7113754
923 - 957	846	Textured black painted/Teksturowana czerń 	2 Unit/Szt	7113854
982 - 1.016	905	Textured black painted/Teksturowana czerń 	2 Unit/Szt	7113954
1.041 - 1.075	964	Textured black painted/Teksturowana czerń 	2 Unit/Szt	7114054
560 - 594	483 (M60)	Painted stone grey/Malowany na kolor kamienno-szary 	2 Unit/Szt	7113049
623 - 657	546	Painted stone grey/Malowany na kolor kamienno-szary 	2 Unit/Szt	7113149
682 - 716	605	Painted stone grey/Malowany na kolor kamienno-szary 	2 Unit/Szt	7113249
741 - 775	664	Painted stone grey/Malowany na kolor kamienno-szary 	2 Unit/Szt	7113349
760 - 794	683 (M80)	Painted stone grey/Malowany na kolor kamienno-szary 	2 Unit/Szt	7113449
798 - 832	721	Painted stone grey/Malowany na kolor kamienno-szary 	2 Unit/Szt	7113549
832 - 866	755	Painted stone grey/Malowany na kolor kamienno-szary 	2 Unit/Szt	7113649
860 - 894	783 (M90)	Painted stone grey/Malowany na kolor kamienno-szary 	2 Unit/Szt	7113749
923 - 957	846	Painted stone grey/Malowany na kolor kamienno-szary 	2 Unit/Szt	7113849
982 - 1.016	905	Painted stone grey/Malowany na kolor kamienno-szary 	2 Unit/Szt	7113949
1.041 - 1.075	964	Painted stone grey/Malowany na kolor kamienno-szary 	2 Unit/Szt	7114049

Aluminium, Plastic/Aluminium, Plastik







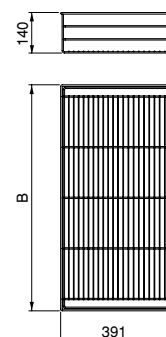
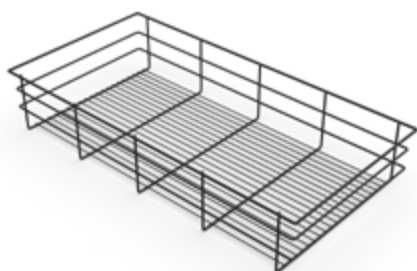

Drawer or wire basket for closets and dressers Hack
Szufłada lub kosz druciany do szafy Hack i komody

B	Finishing/Wykończenie		Packaging/Opakowanie	Cod.
482 (M60)	Textured black painted/Teksturowana czerni		2 Unit/Szt	7114754
682 (M80)	Textured black painted/Teksturowana czerni		2 Unit/Szt	7114854
782 (M90)	Textured black painted/Teksturowana czerni		2 Unit/Szt	7114954
482 (M60)	Painted stone grey/Malowany na kolor kamienno-szary		2 Unit/Szt	7114749
682 (M80)	Painted stone grey/Malowany na kolor kamienno-szary		2 Unit/Szt	7114849
782 (M90)	Painted stone grey/Malowany na kolor kamienno-szary		2 Unit/Szt	7114949

Steel/Stal



Shoe drawer for closets and dressers Hack
Szufłada na buty do szafy i garderoby Hack

B	Finishing/Wykończenie		Packaging/Opakowanie	Cod.
482 (M60)	Textured black painted/Teksturowana czerni		2 Unit/Szt	7114454
682 (M80)	Textured black painted/Teksturowana czerni		2 Unit/Szt	7114554
782 (M90)	Textured black painted/Teksturowana czerni		2 Unit/Szt	7114654
482 (M60)	Painted stone grey/Malowany na kolor kamienno-szary		2 Unit/Szt	7114449
682 (M80)	Painted stone grey/Malowany na kolor kamienno-szary		2 Unit/Szt	7114549
782 (M90)	Painted stone grey/Malowany na kolor kamienno-szary		2 Unit/Szt	7114649

Steel/Stal

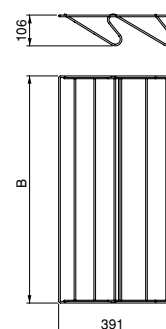
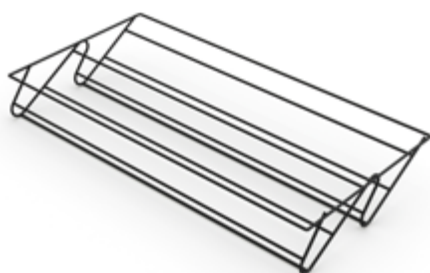

Tray or shelf for closets and dressers Hack
 Taca lub półka do szaf i garderoby Hack

B	Finishing/Wykończenie		Packaging/Opakowanie	Cod.
483 (M60)	Textured black painted/Teksturowana czerni		2 Unit/Szt	7115154
683 (M80)	Textured black painted/Teksturowana czerni		2 Unit/Szt	7115254
783 (M90)	Textured black painted/Teksturowana czerni		2 Unit/Szt	7115354
483 (M60)	Painted stone grey/Malowany na kolor kamienno-szary		2 Unit/Szt	7115149
683 (M80)	Painted stone grey/Malowany na kolor kamienno-szary		2 Unit/Szt	7115249
783 (M90)	Painted stone grey/Malowany na kolor kamienno-szary		2 Unit/Szt	7115349

Steel/Stal

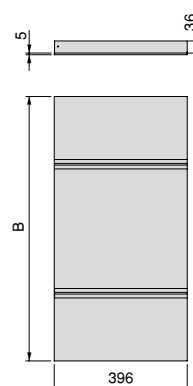
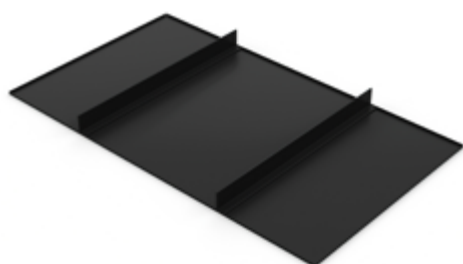

Organizer drawer for closets and dressers Hack
 Szuflada organizacyjna do szafy i garderoby Hack

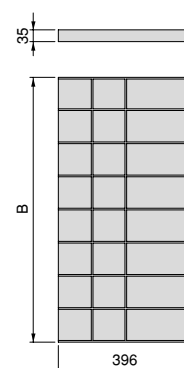

B	Finishing/Wykończenie		Packaging/Opakowanie	Cod.
483 (M60)	Painted stone grey/Malowany na kolor kamienno-szary		1 Unit/Szt	7111149
683 (M80)	Painted stone grey/Malowany na kolor kamienno-szary		1 Unit/Szt	7111249
783 (M90)	Painted stone grey/Malowany na kolor kamienno-szary		1 Unit/Szt	7111349

Wood/Drewno



Side spacer for Hack frame

Boczny element dystansowy do ramy Hack

Finishing/Wykończenie	Packaging/Opakowanie	Cod.
Black plastic/Czarny plastik 	4 Unit/Szt	7115417
Stone grey plastic/Plastik kamienno-szary 	4 Unit/Szt	7115436

Plastic/Plastik

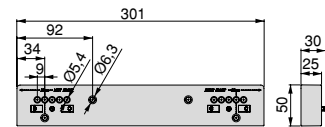



A spacer is required on the side of the cabinet where it coincides with the door and is installed in the place where the guide goes. Its function is to leave a space of 25mm between the frame and the side of the cabinet so that the door does not collide with the frame.

You can first install the spacer to the cabinet with $\varnothing 4 \times 25$ mm screws and then attach the slide with EURO $\varnothing 6,2 \times 13$ mm screws. Or you can pre-mount the spacer to the rail with the built-in clips, and then attach the assembly to the cabinet with $\varnothing 4 \times 40$ mm screws.

Po stronie szafki w miejscu, w którym styka się ona z drzwiami, wymagany jest element dystansowy, który montuje się w miejscu, w którym przebiega prowadnica. Jego zadaniem jest pozostawienie 25 mm wolnej przestrzeni pomiędzy ramą a bokiem korpusu, tak aby drzwi nie kolidowały z ramą. Podkładkę dystansową można najpierw przymocować do korpusu za pomocą wkrętów $\varnothing 4 \times 25$ mm, a następnie zamocować szynę za pomocą wkrętów EURO $\varnothing 6,2 \times 13$ mm. Można też zamocować tuleję dystansową do szyny za pomocą klipsów, a następnie przymocować ją do obudowy za pomocą śrub $\varnothing 4 \times 40$ mm.

Set of 7 trouser rods for closets and dressing rooms Hack

Zestaw 7 drążków na spodnie do szafy Hack i garderoby

N° pieces/Liczba elementów	Finishing/Wykończenie	Packaging/Opakowanie	Cod.
7 units/7 jednostki	Textured black painted/Teksturowana czerń 	1 LOT/Partia	7112054
7 units/7 jednostki	Painted stone grey/Malowany na kolor kamienno-szary 	1 LOT/Partia	7112049

Aluminium, Plastic/Aluminium, Plastik

x7

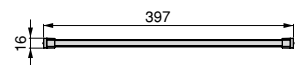

Closet and dressing room organizer basket Hack
 Kosz organizacyjny do szafy i garderoby Hack

Finishing/Wykończenie	Packaging/Opakowanie	Cod.
Grey textil effect/Efekt szarej tkaniny 	6 Unit/Szt	7115827

Fabric/Tkanina

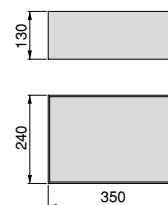

Auxiliary tray for closets and dressing rooms Hack
 Taca pomocnicza do szafy Hack i garderoby

Finishing/Wykończenie	Packaging/Opakowanie	Cod.
Not defined/Nieokreślone 	2 Unit/Szt	7115920

Plastic/Plastik

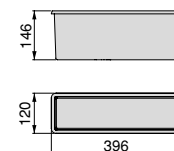

Hack compositions Hack kompozycje

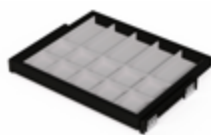
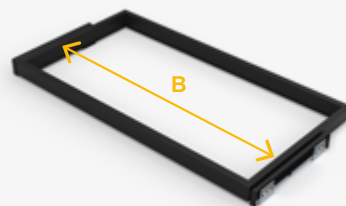

7113054 + 7111149
483 (M60)

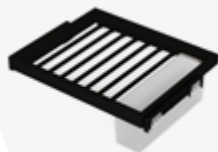

7113154 + 7112054 + 7115920
B = 546

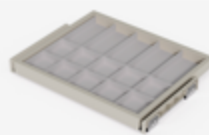

7113049 + 7111149483 (M60)



7113149 + 7112049 + 7115920
B = 546

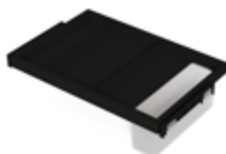

7113254 + 7115154 + 7115920
B = 605

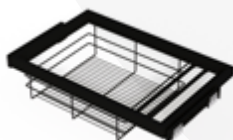

7113354 + 7114754 + 7112054
B = 664

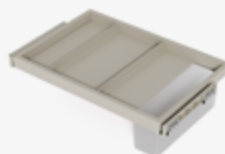

7113249 + 7115149 + 7115920
B = 605

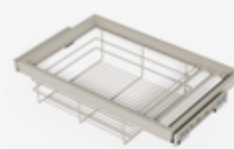

7113349 + 7114749 + 7112049
B = 664

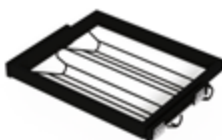

7113454 + 7114554
B = 683 (M80)

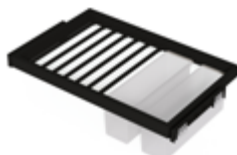

7113554 + 7112054 + 7115920
B = 721



7113449 + 7114549
B = 683 (M80)



7113549 + 7112054 + 7115920
B = 721

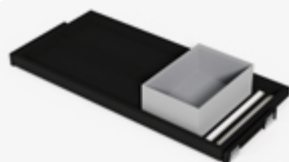

7113654 + 7115354 + 7112054 + 7115827
B = 755

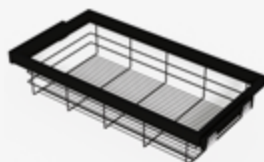

7113754 + 7114954
B = 783 (M90)

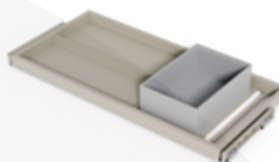

7113649 + 7115349 + 7112049 + 7115827
B = 755



7113749 + 7114949
B = 783 (M90)

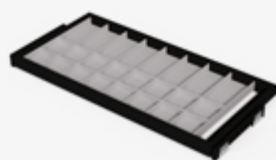

7113854 + 7111349 + 7112054
B = 846

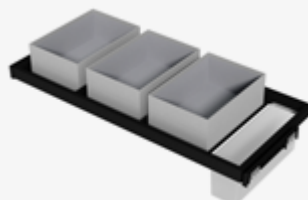

7113954 + 7115354 + 7115920 + 7115827
B = 905

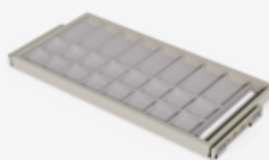

7113849 + 7111349 + 7112049
B = 846

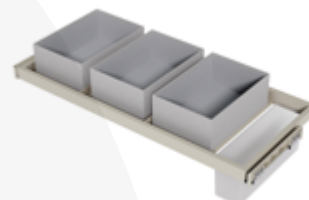

7113949 + 7115349 + 7115920 + 7115827
B = 905

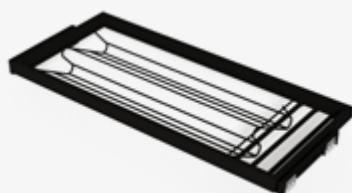

7114054 + 7114654 + 7112054
B = 964



7114049 + 7114649 + 7112049
B = 964

Hack kits Hack zestawy

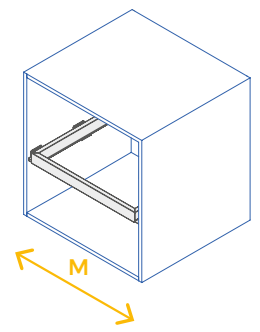

7028449
B = 483 (M60)

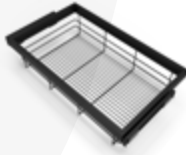

7028549
683 (M80)



7028554
B = 783 (M90)



7028349
B = 483 (M60)

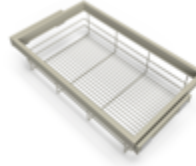

7028354
683 (M80)



7028454
783 (M90)



7028054
B = 483 (M60)

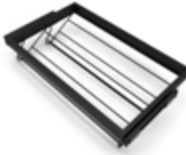

7028154
683 (M80)

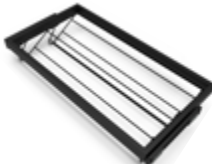

7028254
B = 783 (M90)

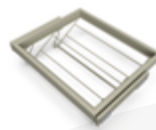

7028049
B = 483 (M60)

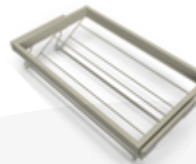

7028149
683 (M80)

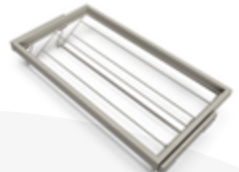

7028249
783 (M90)

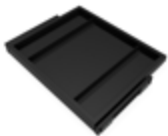

7029149
B = 483 (M60)



7028954
683 (M80)

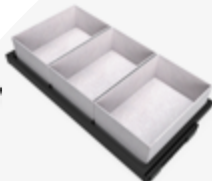

7029154
B = 783 (M90)

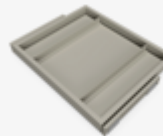

7028949
B = 483 (M60)

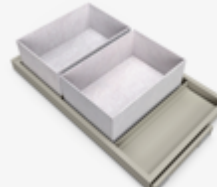

7029049
683 (M80)



7029054
783 (M90)



7028654
483 (M60)



7028754
683 (M80)

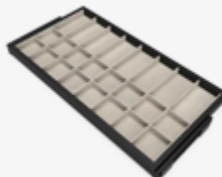

7028854
B = 783 (M90)

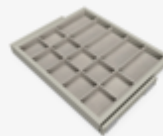

7028649
B = 483 (M60)

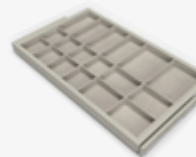

7028749
683 (M80)

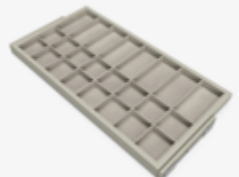

7028849
783 (M90)



7029254
B = 483 (M60)

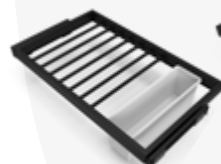

7029354
B = 683 (M80)

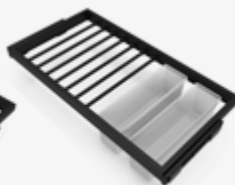

7029454
B = 783 (M90)



7029249
B = 483 (M60)

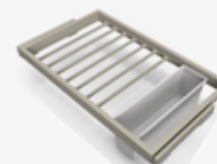

7029349
683 (M80)

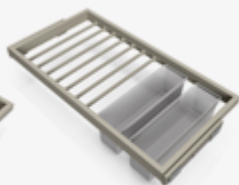

7029449
783 (M90)

Hack pull out wire drawer kit for wardrobes
 Zestaw koszy drucianych Hack do szaf

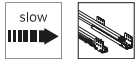

A	B	Finishing/Wykończenie	Packaging/Opakowanie	Cod.
560 - 594	483 (M60)	Painted stone grey/Malowany na kolor kamienno-szary	1 KIT/Zestaw	7028349
760 - 794	683 (M80)	Painted stone grey/Malowany na kolor kamienno-szary	1 KIT/Zestaw	7028449
560 - 594	483 (M60)	Textured black painted/Teksturowana czern	1 KIT/Zestaw	7028354
860 - 894	783 (M90)	Painted stone grey/Malowany na kolor kamienno-szary	1 KIT/Zestaw	7028549
760 - 794	683 (M80)	Textured black painted/Teksturowana czern	1 KIT/Zestaw	7028454
860 - 894	783 (M90)	Textured black painted/Teksturowana czern	1 KIT/Zestaw	7028554

Aluminium, Plastic, Steel/Aluminium, Plastik, Stal

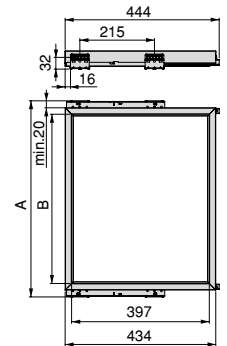
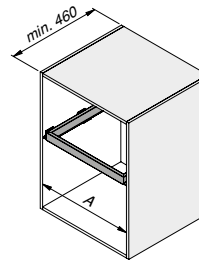

Hack Wire shoe rack kit for wardrobes
 Zestaw drucianych półek na buty Hack do szaf

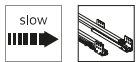

A	B	Finishing/Wykończenie	Packaging/Opakowanie	Cod.
560 - 594	483 (M60)	Painted stone grey/Malowany na kolor kamienno-szary	1 KIT/Zestaw	7028049
760 - 794	683 (M80)	Painted stone grey/Malowany na kolor kamienno-szary	1 KIT/Zestaw	7028149
860 - 894	783 (M90)	Painted stone grey/Malowany na kolor kamienno-szary	1 KIT/Zestaw	7028249
560 - 594	483 (M60)	Textured black painted/Teksturowana czern	1 KIT/Zestaw	7028054
760 - 794	683 (M80)	Textured black painted/Teksturowana czern	1 KIT/Zestaw	7028154
860 - 894	783 (M90)	Textured black painted/Teksturowana czern	1 KIT/Zestaw	7028254

Aluminium, Plastic, Steel/Aluminium, Plastik, Stal

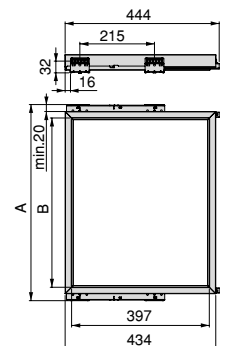
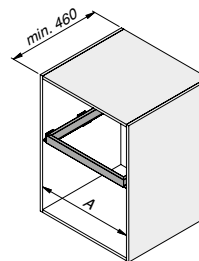

Hack Kit of tray and rack with slides for wardrobe

Kit taca lub półka do szaf i garderoby Hack

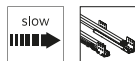

A	B	Finishing/Wykończenie	Packaging/Opakowanie	Cod.
560 - 594	483 (M60)	Painted stone grey/Malowany na kolor kamienno-szary	1 KIT/Zestaw	7028949
860 - 894	783 (M90)	Painted stone grey/Malowany na kolor kamienno-szary	1 KIT/Zestaw	7029149
760 - 794	683 (M80)	Painted stone grey/Malowany na kolor kamienno-szary	1 KIT/Zestaw	7029049
560 - 594	483 (M60)	Textured black painted/Teksturowana czern	1 KIT/Zestaw	7028954
760 - 794	683 (M80)	Textured black painted/Teksturowana czern	1 KIT/Zestaw	7029054
860 - 894	783 (M90)	Textured black painted/Teksturowana czern	1 KIT/Zestaw	7029154

Aluminium, Fabric, Plastic, Steel/Aluminium, Plastik, Stal, Tkanina

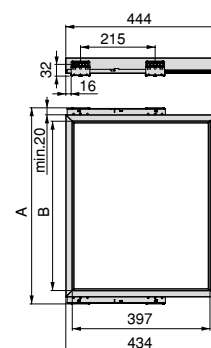
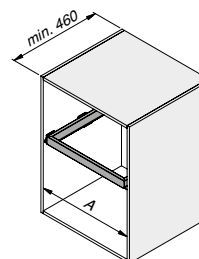

Kit organizer drawer Hack for wardrobes

Zestaw szuflada z przegródkami Hack do szafy

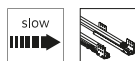

A	B	Finishing/Wykończenie	Packaging/Opakowanie	Cod.
560 - 594	483 (M60)	Painted stone grey/Malowany na kolor kamienno-szary	1 KIT/Zestaw	7028649
760 - 794	683 (M80)	Painted stone grey/Malowany na kolor kamienno-szary	1 KIT/Zestaw	7028749
860 - 894	783 (M90)	Painted stone grey/Malowany na kolor kamienno-szary	1 KIT/Zestaw	7028849
560 - 594	483 (M60)	Textured black painted/Teksturowana czern	1 KIT/Zestaw	7028654
760 - 794	683 (M80)	Textured black painted/Teksturowana czern	1 KIT/Zestaw	7028754
860 - 894	783 (M90)	Textured black painted/Teksturowana czern	1 KIT/Zestaw	7028854

Aluminium, Plastic, Wood/Aluminium, Drewno, Plastik

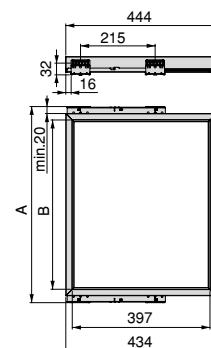
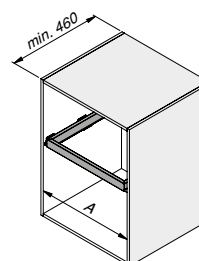

Trouser rod kit Hack for wardrobes

Zestaw na spodnie Hack do szafy

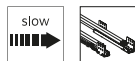

A	B	Finishing/Wykończenie	Packaging/Opakowanie	Cod.
560 - 594	483 (M60)	Painted stone grey/Malowany na kolor kamienno-szary	1 KIT/Zestaw	7029249
760 - 794	683 (M80)	Painted stone grey/Malowany na kolor kamienno-szary	1 KIT/Zestaw	7029349
860 - 894	783 (M90)	Painted stone grey/Malowany na kolor kamienno-szary	1 KIT/Zestaw	7029449
560 - 594	483 (M60)	Textured black painted/Teksturowana czern	1 KIT/Zestaw	7029254
760 - 794	683 (M80)	Textured black painted/Teksturowana czern	1 KIT/Zestaw	7029354
860 - 894	783 (M90)	Textured black painted/Teksturowana czern	1 KIT/Zestaw	7029454

Aluminium, Plastic/Aluminium, Plastik

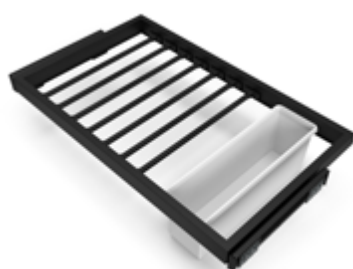

Pull-out side shoe rack for closets and walk-in closets Hack

Wysuwana półka na buty do szafy typu Hack i garderoby typu walk-in



Hand/Uchwyty	Finishing/Wykończenie	Packaging/Opakowanie	Cod.
Right/Prawy	Painted stone grey/Malowany na kolor kamienno-szary	1 Unit/Szt	7112649
Left/Lewy	Painted stone grey/Malowany na kolor kamienno-szary	1 Unit/Szt	7112749
Right/Prawy	Textured black painted/Teksturowana czern	1 Unit/Szt	7112654
Left/Lewy	Textured black painted/Teksturowana czern	1 Unit/Szt	7112754

Steel/Stal



Left/Lewy



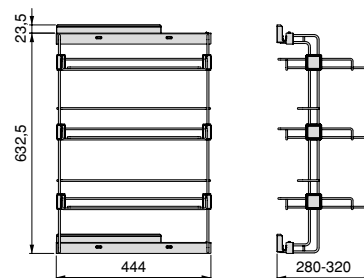

Right/Prawy



Pull-out trouser rack
 Wysuwany wieszak na spodnie





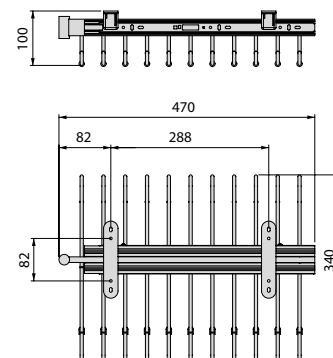
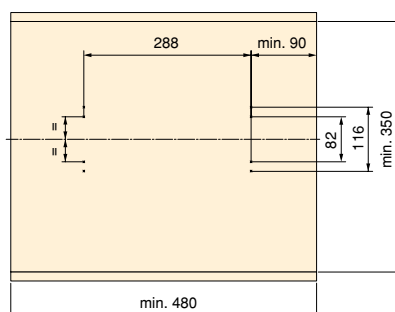

Finishing/Wykończenie	Packaging/Opakowanie	Cod.
Chrome plated/Chromowane 	1 Unit/Szt	7017811
Black painted/Malowane na czarno 	1 Unit/Szt	7017814
Painted stone grey/Malowany na kolor kamienno-szary 	1 Unit/Szt	7017849

Steel/Stal



Pull-out mirror for inside wardrobe
 Wysuwane lustro do szafy



Finishing/Wykończenie	Packaging/Opakowanie	Cod.
Moka painted/Malowane na kolor mokka 	1 Unit/Szt	7018013
Silver painted/Malowane aluminium 	1 Unit/Szt	7018025
Painted stone grey/Malowany na kolor kamienno-szary 	1 Unit/Szt	7018049
Textured black painted/Teksturowana czerni 	1 Unit/Szt	7018054

Glass, Plastic, Steel/Plastik, Stal, Szkło

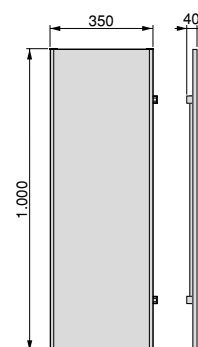
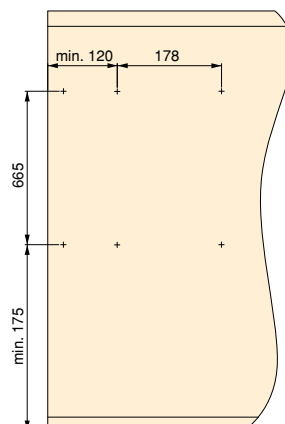
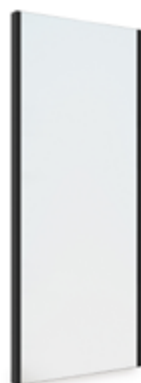

Moka accessories Akcesoria Moka

The Moka wardrobe and dressing room accessories are specially designed to organise your home in the most elegant way.

Szafy i akcesoria do garderoby Moka zostały specjalnie zaprojektowane, aby zorganizować dom w najbardziej elegancki sposób.

30kg

slow

partial

min.480

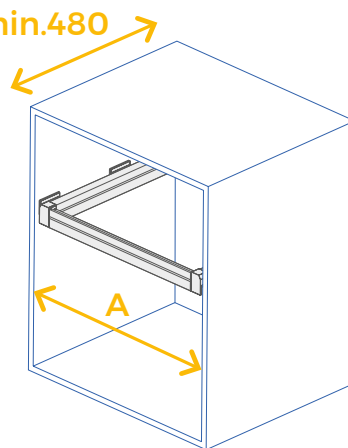

There is a range of wardrobe recesses from 564 to 1,114 mm (A) wide for the installation of the racks.

Dostępne są wnęki na szafy o szerokości od 564 do 1114 mm (A) do montażu regałów.

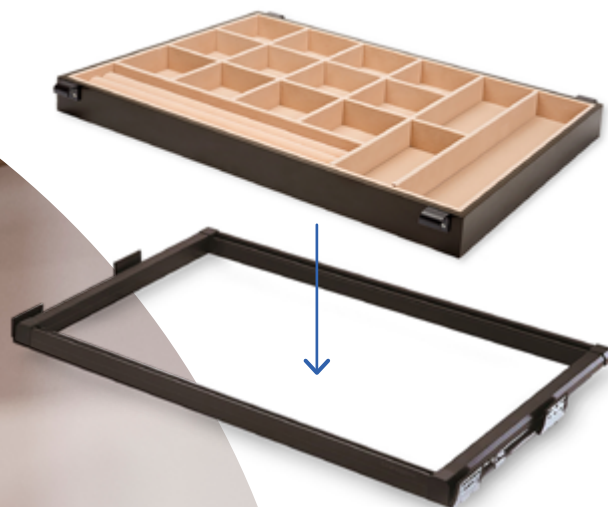

The spacer leaves a 25mm gap between the frame and the side of the wardrobe.

Element dystansowy pozostawia szczelinę 25 mm między ramą a bokiem szafy.

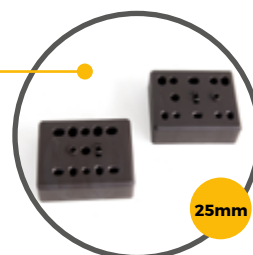

It has a mocha coloured painted finish.

Ma lakierowane wykończenie w kolorze mokka.

RAL 8019



Set of hooks for installing a border on the frame.

Zestaw haczyków do montażu obramowania na ramie.

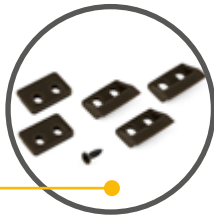

Moka



Moka accessories
Akcesoria Moka



Moka frame with runners
Moka rama z prowadnicami

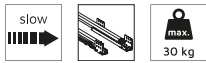

A	B	Finishing/Wykończenie	Packaging/Opakowanie	Cod.
564 - 614	484 - 534	Moka painted/Malowane na kolor mokka	1 Unit/Szt	6930013
614 - 664	534 - 584	Moka painted/Malowane na kolor mokka	1 Unit/Szt	6929913
664 - 714	584 - 634	Moka painted/Malowane na kolor mokka	1 Unit/Szt	6930113
714 - 764	634 - 684	Moka painted/Malowane na kolor mokka	1 Unit/Szt	6930613
764 - 814	684 - 734	Moka painted/Malowane na kolor mokka	1 Unit/Szt	6930213
814 - 864	734 - 784	Moka painted/Malowane na kolor mokka	1 Unit/Szt	6930713
864 - 914	784 - 834	Moka painted/Malowane na kolor mokka	1 Unit/Szt	6930313
914 - 964	834 - 884	Moka painted/Malowane na kolor mokka	1 Unit/Szt	6930813
964 - 1.014	884 - 934	Moka painted/Malowane na kolor mokka	1 Unit/Szt	6930413
1.014 - 1.064	934 - 984	Moka painted/Malowane na kolor mokka	1 Unit/Szt	6930913
1.064 - 1.114	984 - 1.014	Moka painted/Malowane na kolor mokka	1 Unit/Szt	6930513

Aluminium, Plastic/Aluminium, Plastik

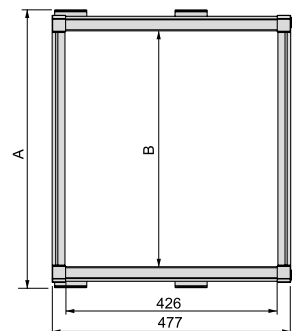
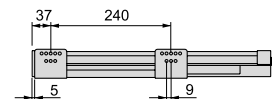
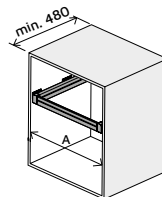

Set of spacers for removable Moka
Boczny zestaw dystansowy do ramy Moka

Finishing/Wykończenie	Packaging/Opakowanie	Cod.
Moka plastic/Plastik w kolorze mokka	4 Pair/Kpl.	6939943

Plastic/Plastik



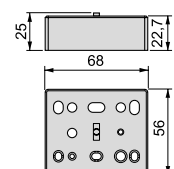

To be used with hinged doors or as a spacer for hollow modules.
Recommended screw $\varnothing 4 \times 40$.

Przeznaczony do drzwi z zawiasami lub jako rozpórka do modułów pustych.
Zalecany wkręt $\varnothing 4 \times 40$.



Metallic drawer Moka for wardrobes
Szufłada metalowa Moka do szaf



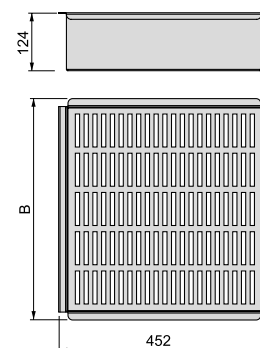

B	Finishing/Wykończenie	Packaging/Opakowanie	Cod.
475	Moka painted/Malowane na kolor mokka 	1 Unit/Szt	6932013
675	Moka painted/Malowane na kolor mokka 	1 Unit/Szt	6932113
775	Moka painted/Malowane na kolor mokka 	1 Unit/Szt	6932213

Steel/Stal



Wire drawer Moka for wardrobes
Wysuwany kosz Moka do szaf



B	Finishing/Wykończenie	Packaging/Opakowanie	Cod.
475	Moka painted/Malowane na kolor mokka 	2 Unit/Szt	6933013
675	Moka painted/Malowane na kolor mokka 	2 Unit/Szt	6933113
775	Moka painted/Malowane na kolor mokka 	2 Unit/Szt	6933213

Steel/Stal

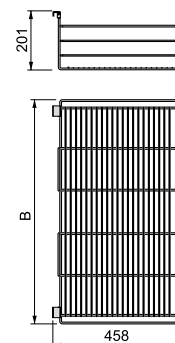

Shoe drawer Moka for wardrobes
Szuflada na buty Moka do szaf



B	Finishing/Wykończenie	Packaging/Opakowanie	Cod.
475	Moka painted/Malowane na kolor mokka	2 Unit/Szt	6937013
675	Moka painted/Malowane na kolor mokka	2 Unit/Szt	6937113
775	Moka painted/Malowane na kolor mokka	2 Unit/Szt	6937213

Steel/Stal

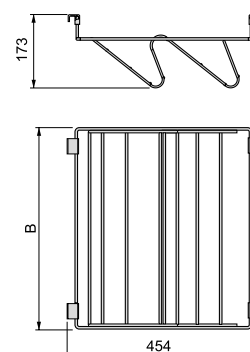
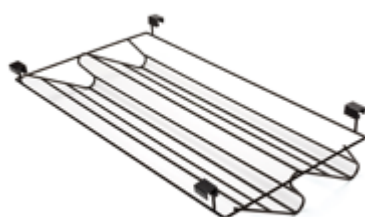

Organizer drawer Moka for wardrobes
Szuflada z przegródkami Moka do szaf



B	Finishing/Wykończenie	Packaging/Opakowanie	Cod.
483	Walnut wood/Drewno orzechowe	1 Unit/Szt	6931075
683	Walnut wood/Drewno orzechowe	1 Unit/Szt	6931175
783	Walnut wood/Drewno orzechowe	1 Unit/Szt	6931275

Wood/Drewno

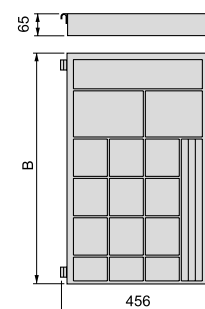

Auxiliary tray Moka for wardrobes
Dodatkowa taca Moka do szaf



B	Finishing/Wykończenie	Packaging/Opakowanie	Cod.
99	Moka painted/Malowane na kolor mokka 	1 Unit/Szt	6939613

Aluminium, Plastic/Aluminium, Plastik

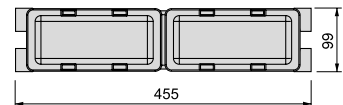

Set of 7 trousers rods Moka for wardrobes
Zestaw 7 wieszaków na spodnie Moka do szaf



N° pieces/Liczba elementów	Finishing/Wykończenie	Packaging/Opakowanie	Cod.
7 units/7 sztuk	Moka painted/Malowane na kolor mokka 	1 LOT/Partia	6934013

Aluminium, Plastic/Aluminium, Plastik

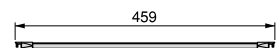
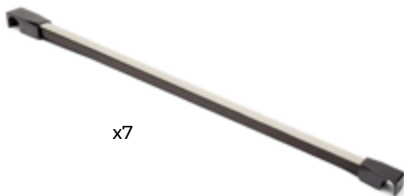

Hanging clip Moka for wardrobes
Wieszak zaciskowy Moka do szaf



Finishing/Wykończenie	Packaging/Opakowanie	Cod.
Moka plastic/Plastik w kolorze mokka 	10 Unit/Szt	6934143

Plastic/Plastik

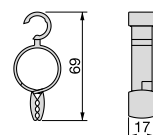

Basket Moka for wardrobes
Kosz Moka do szaf



B	Finishing/Wykończenie	Packaging/Opakowanie	Cod.
355	Moka painted/Malowane na kolor mokka	1 Unit/Szt	6934213

Fabric, Steel/Stal, Tkanina

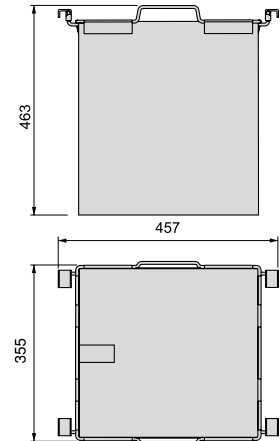

Moka pull out shoe rack drawer
Zestaw wysuwanych szuflad na buty Moka

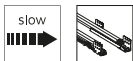

A	M	Finishing/Wykończenie	Packaging/Opakowanie	Cod.
564 - 594	600 mm	Moka painted/Malowane na kolor mokka	1 Unit/Szt	6936013
764 - 794	800 mm	Moka painted/Malowane na kolor mokka	1 Unit/Szt	6936113
864 - 894	900 mm	Moka painted/Malowane na kolor mokka	1 Unit/Szt	6936213

Steel/Stal

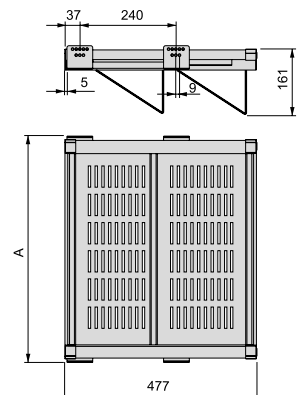

Pull-out trouser rack
Wysuwany wieszak



Hand/Uchwyt	Finishing/Wykończenie	Packaging/Opakowanie	Cod.
Left/Lewy	Moka painted/Malowane na kolor mokka	1 Unit/Szt	6912813
Right/Prawy	Moka painted/Malowane na kolor mokka	1 Unit/Szt	6923413
Left/Lewy	Silver painted/Malowane aluminium	1 Unit/Szt	6912825
Right/Prawy	Silver painted/Malowane aluminium	1 Unit/Szt	6923425

Plastic, Steel/Plastik, Stal

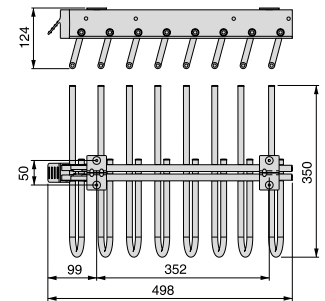
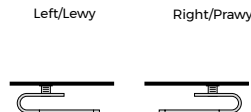

Moka pull out lateral shoe rack
Wysuwana boczna szuflada na buty do wnętrza szafy Moka

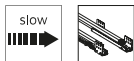

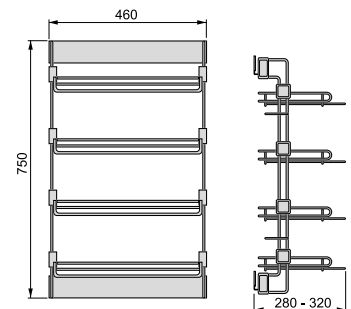
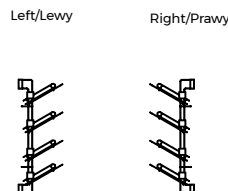

Hand/Uchwyt	Finishing/Wykończenie	Packaging/Opakowanie	Cod.
Left/Lewy	Moka painted/Malowane na kolor mokka	1 Unit/Szt	6938413
Right/Prawy	Moka painted/Malowane na kolor mokka	1 Unit/Szt	6938513

Steel/Stal

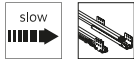

Moka extractable hanger for wardrobe
 Wysuwany wieszak Moka do szafy



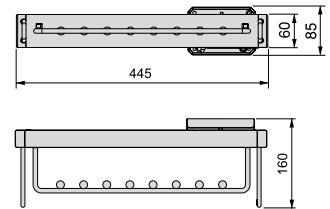

Finishing/Wykończenie	Packaging/Opakowanie	Cod.
Moka painted/Malowane na kolor mokka 	1 Unit/Szt	6938713

Aluminium, Plastic/Aluminium, Plastik

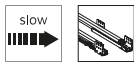

Moka extractable lateral tie rack
 Wysuwany boczny wieszak na krawaty Moka



Finishing/Wykończenie	Packaging/Opakowanie	Cod.
Moka painted/Malowane na kolor mokka 	1 Unit/Szt	6938813

Aluminium, Plastic/Aluminium, Plastik

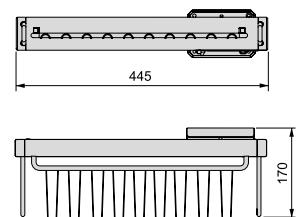

Moka extractable mirror for inside wardrobe
Wysuwane lustro do szafy Moka

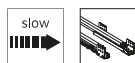

Width/Szerokość	Finishing/Wykończenie	Packaging/Opakowanie	Cod.
440	Moka painted/Malowane na kolor mokka	1 Unit/Szt	6938613

Aluminium, Plastic/Aluminium, Plastik

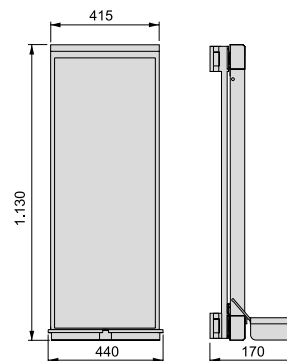
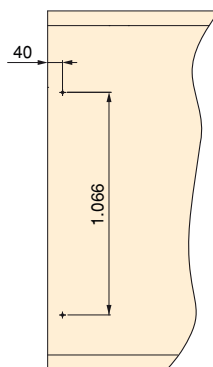

Pull-out mirror for inside wardrobe
Wysuwane lustro do szafy



Finishing/Wykończenie	Packaging/Opakowanie	Cod.
Moka painted/Malowane na kolor mokka	1 Unit/Szt	7018013
Silver painted/Malowane aluminium	1 Unit/Szt	7018025
Painted stone grey/Malowany na kolor kamienno-szary	1 Unit/Szt	7018049
Textured black painted/Teksturowana czerni	1 Unit/Szt	7018054

Glass, Plastic, Steel/Plastik, Stal, Szkło

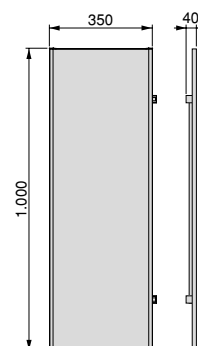
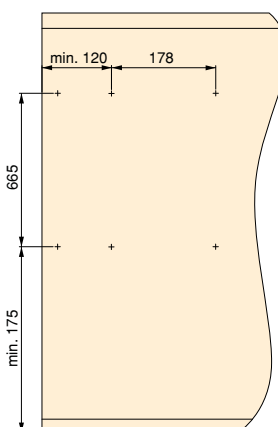

Wardrobe side mounting Self trouser rack
 Wieszak na spodnie Self do montażu bocznego w szafie

Hand/Uchwyty	Finishing/Wykończenie	Packaging/Opakowanie	Cod.
Left hand/Lewa ręka	Chrome plated/Chromowane	1 Unit/Szt	7018111
Right hand/Prawa ręka	Chrome plated/Chromowane	1 Unit/Szt	7018211

Aluminium, Plastic, Steel/Aluminium, Plastik, Stal

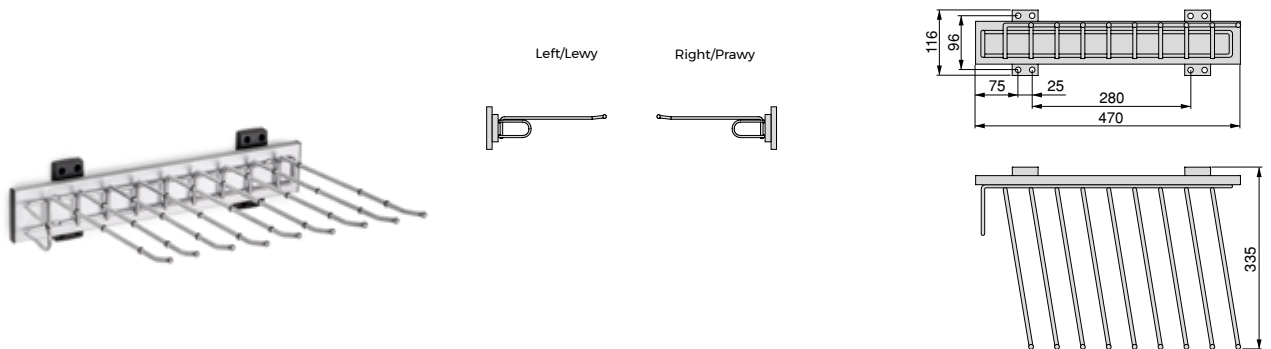

Self Pullout double trouser rack for wardrobes.
 Zdejmowany podwójny wieszak na spodnie Self do szafy.

Finishing/Wykończenie	Packaging/Opakowanie	Cod.
Chrome plated/Chromowane	1 Unit/Szt	7017911

Plastic, Steel/Plastik, Stal

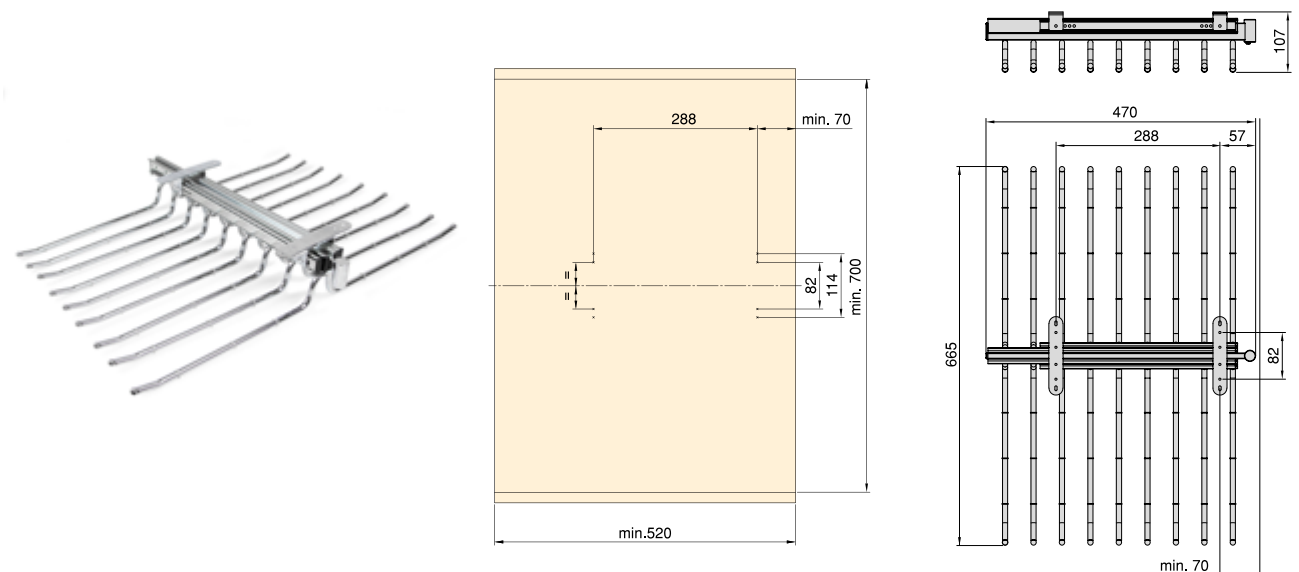

Self pull-out lateral trouser rack
Wysuwany boczny wieszak na spodnie Self

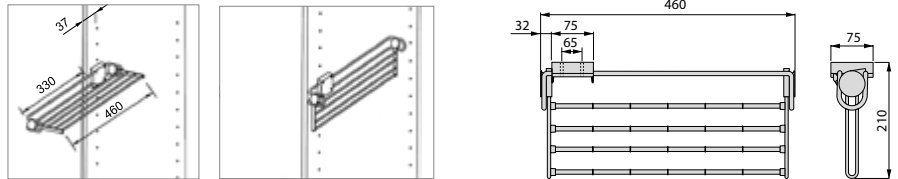

Finishing/Wykończenie	Packaging/Opakowanie	Cod.
Silver painted/Malowane aluminium 	1 Unit/Szt	621125

Plastic, Steel/Plastik, Stal



Pull-out trouser rack
Wysuwany wieszak na spodnie



Finishing/Wykończenie	Packaging/Opakowanie	Cod.
Chrome plated/Chromowane 	1 Unit/Szt	7017811
Black painted/Malowane na czarno 	1 Unit/Szt	7017814
Painted stone grey/Malowany na kolor kamienno-szary 	1 Unit/Szt	7017849

Steel/Stal

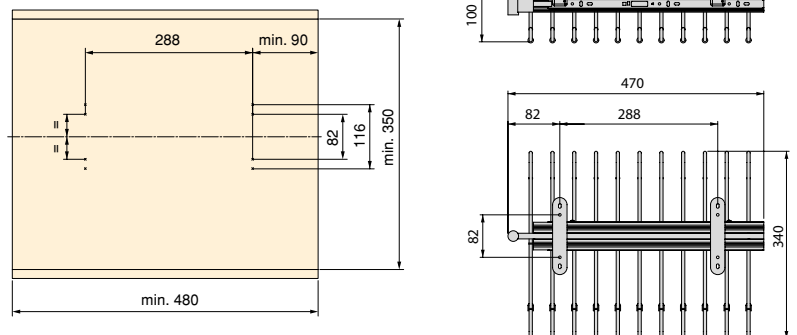

Self Pull-out wardrobe rail
 Wysuwany wieszak Self do szafy

A	B	L	Finishing/Wykończenie	Packaging/Opakowanie	Cod.
335	302	300	Silver painted/Malowane aluminium	10 Unit/Szt	6210925
385	352	350	Silver painted/Malowane aluminium	10 Unit/Szt	6210825
435	402	400	Silver painted/Malowane aluminium	10 Unit/Szt	6210725
485	452	450	Silver painted/Malowane aluminium	10 Unit/Szt	6210625

Plastic, Steel/Plastik, Stal





Self extractable hanger for very deep wardrobes
 Wysuwany wieszak do szafy Self

Longitude/Długość	Finishing/Wykończenie	Packaging/Opakowanie	Cod.
800	Black painted/Malowane na czarno	1 Unit/Szt	7005714
800	Silver painted/Malowane aluminium	1 Unit/Szt	7005725

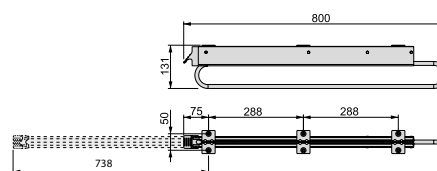
Plastic, Steel/Plastik, Stal



Extractable hanger for wardrobe
Wysuwany wieszak do szafy

Finishing/Wykończenie	Packaging/Opakowanie	Cod.
Black painted/Malowane na czarno 	1 Unit/Szt	6916314
Matt anodized/Anodyzowany mat 	1 Unit/Szt	6916362

Aluminium/Aluminium

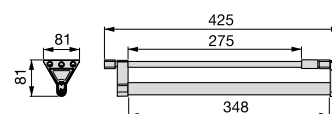

Self shoe rack for inside wardrobe
Stojak na buty Self do wnętrza szafy

Finishing/Wykończenie	Packaging/Opakowanie	Cod.
Silver painted/Malowane aluminium 	1 Unit/Szt	6211225

Plastic, Steel/Plastik, Stal

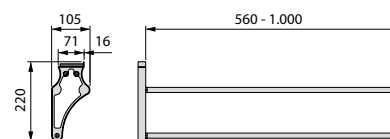

Pull-out hanging rail for Keeper wardrobe
Wysuwany drążek do szafy Ø14

Finishing/Wykończenie	Packaging/Opakowanie	Cod.
Chrome plated/Chromowane 	1 Unit/Szt	7910611

Steel/Stal

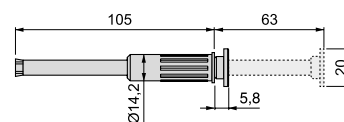
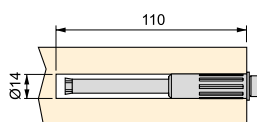

Self pull-out lateral tie
 Wysuwany boczny wieszak na krawaty Self

Finishing/Wykończenie	Packaging/Opakowanie	Cod.
Silver painted/Malowane aluminium 	10 Unit/Szt	6211025

Plastic, Steel/Plastik, Stal

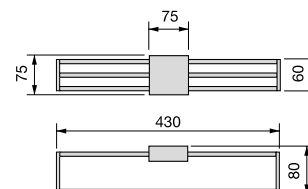

Extractable lateral tie rack for wardrobe
 Wysuwany wieszak na krawaty do montażu z boku szafy

Finishing/Wykończenie	Packaging/Opakowanie	Cod.
Matt anodized/Anodyzowany mat 	1 Unit/Szt	7913862

Aluminium, Plastic/Aluminium, Plastik

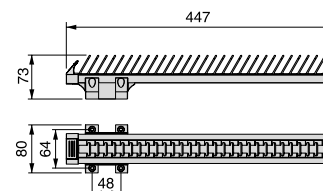

Extractable lateral belt holder
 Wysuwany boczny wieszak na paski

Finishing/Wykończenie	Packaging/Opakowanie	Cod.
Matt anodized/Anodyzowany mat 	1 Unit/Szt	7913962

Aluminium, Plastic/Aluminium, Plastik

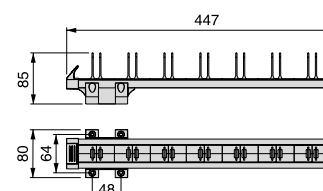

Lader Bookcases Szafka Lader

Structures for making shelves, made of high-strength 25x10mm steel tube.

Estruturas para fazer prateleiras, feitas de tubo de aço 25x10mm de grande resistência.

30kg



Includes 4 shelves 690 mm long and 19 mm thick, manufactured with an oak finish board.

Inclui 4 prateleiras, de 690 mm de comprimento e 19 mm de espessura, feitas de tábua de acabamento em carvalho.



Includes all the accessories for the assembly of the shelves, wall fixing and levellers for stability.

Inclui todos os acessórios para a montagem das prateleiras, fixação à parede e niveladores para estabilidade.

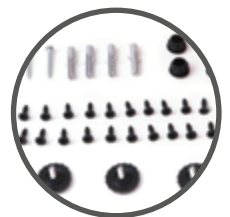

Structure for Lader bookcases
Stelaż do szafki Lader



Height/Wysokość	Finishing/Wykończenie	Packaging/Opakowanie	Cod.
830	Black painted/Malowane na czarno	1 Pair/Kpl.	4450014
1150	Black painted/Malowane na czarno	1 Pair/Kpl.	4450114
1790	Black painted/Malowane na czarno	1 Pair/Kpl.	4450314

Steel/Stal

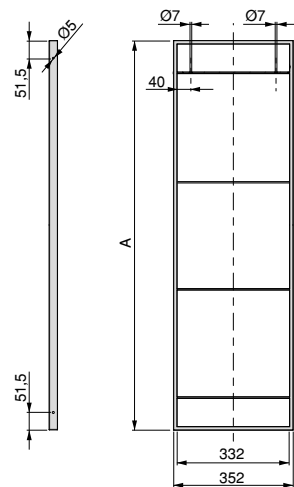

Lader Bookcases with structure and shelves
Szafka Lader ze stelażem i półkami



Width/Szerokość	Height/Wysokość	Finishing/Wykończenie	Packaging/Opakowanie	Cod.
690	1150	Black painted/Malowane na czarno	1 KIT/Zestaw	4450214

Steel, Wood/Drewno, Stal

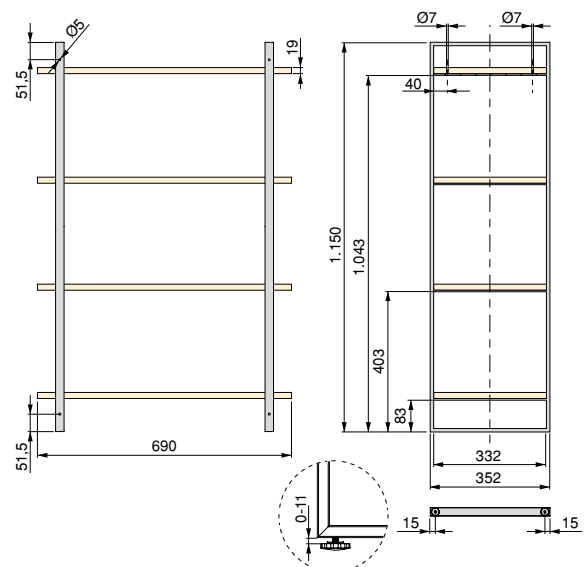

Jagmet structure System Jagmet

Discover these modular shelves designed to equip the interior of wardrobes, dressing rooms, shops, laundry rooms, pantries, storerooms... and an infinite number of spaces.

Odkryj te modułowe półki zaprojektowane do wyposażenia wnętrza szaf, garderób, sklepów, pralni, spiżarni, magazynów... i nieskończonej liczby przestrzeni.

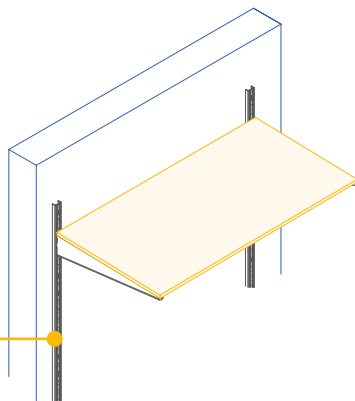

The double groove profile with 32 mm pitch and the support are designed to make shelves with boards.

Profil z podwójnym rowkiem o rozstawie 32 mm i wspornik są przeznaczone do tworzenia półek z płyt.

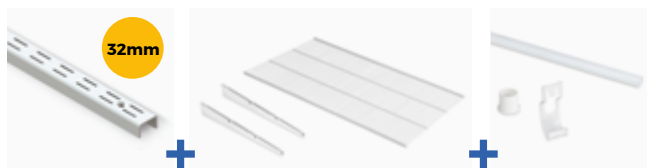
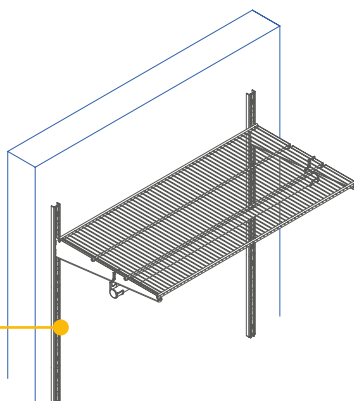

The wire shelves are used in combination with the 32 mm pitch profiles and with the cabinet rail, as they are equipped with slots for the installation of the rail.

Półki druciane są używane w połączeniu z profilami o rozstawie 32 mm i szyną do szaf, ponieważ są wyposażone w otwory do montażu szyny.

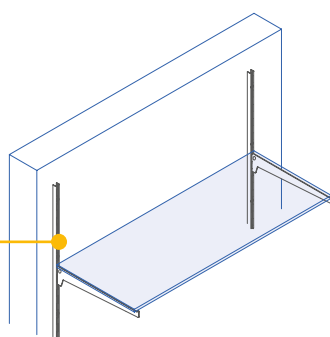

The single groove profile with 50 mm pitch and the bracket are designed for shelving with glass.

Profil z pojedynczym rowkiem o rozstawie 50 mm i wspornik są przeznaczone do półek ze szkłem.

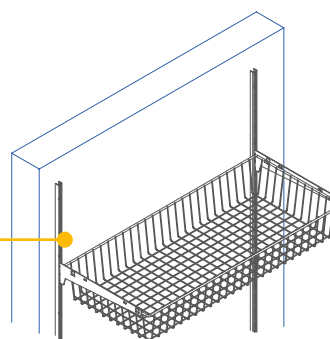

The wire baskets are removable and are designed to be used together with the 50 mm pitch and 32 mm pitch profiles.

Koszki druciane są wyjmowalne i przeznaczone do stosowania z profilami o rozstawie 50 mm i 32 mm.



The rods are placed over the holes, allowing the hanger to be folded down without falling out.

Pręty są umieszczone nad otworami, umożliwiając złożenie wieszaka bez ryzyka wypadnięcia.

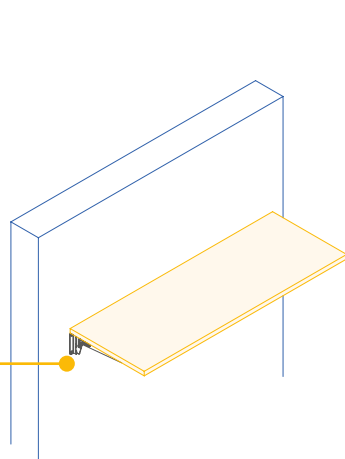
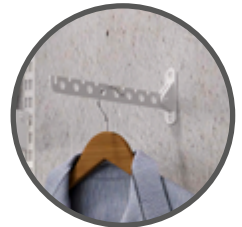

This kit consists of eight fixing plates and four sets of shelf brackets.

Zestaw składa się z ośmiu płyt mocujących i czterech zestawów wsporników półek.

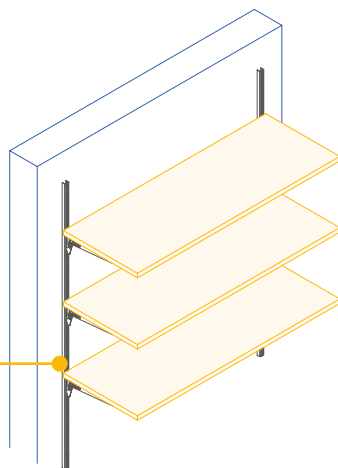

This kit consists of two 1 m single-slotted rack profiles and three sets of shelf brackets.



Zestaw składa się z dwóch profili regału z pojedynczym rowkiem o długości 1 m i trzech zestawów wsporników półek.



**Jagmet structure
System Jagmet**



Profili di fissaggio a parete Jagmet con scanalatura singola e passo 50 mm
Jagmet Einschlitzz-Wandbefestigungsprofile, 50 mm Abstand



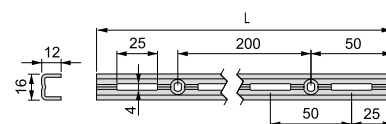

Lunghezza/Längengrad	Finitura/Fertigstellung	Imballaggio/Verpackung	N° pezzi/Nr. Stücke	Cod.	
1 m	Verniciato bianco/Weiß		1 LOTTO/Partie	10 unità/10 Einheiten	7907812
2.0 m	Verniciato bianco/Weiß		1 LOTTO/Partie	10 unità/10 Einheiten	7909112
2.5 m	Verniciato bianco/Weiß		1 LOTTO/Partie	10 unità/10 Einheiten	7909212

Acciaio/Stahl



50mm

Reggipiani Jagmet con scanalatura singola e con passo 50 mm
Regalträger Jagmet für Profil mit Durchlass 50 mm

Portata/Belastung	Lunghezza/Längengrad	Finitura/Fertigstellung	Imballaggio/Verpackung	N° pezzi/Nr. Stücke	Cod.	
40	200	Verniciato bianco/Weiß		1 LOTTO/Partie	20 unità/20 Einheiten	7908012
32	250	Verniciato bianco/Weiß		1 LOTTO/Partie	20 unità/20 Einheiten	7908112
26	300	Verniciato bianco/Weiß		1 LOTTO/Partie	20 unità/20 Einheiten	7908212
23	350	Verniciato bianco/Weiß		1 LOTTO/Partie	20 unità/20 Einheiten	7908312
20	400	Verniciato bianco/Weiß		1 LOTTO/Partie	20 unità/20 Einheiten	7908412

Acciaio/Stahl

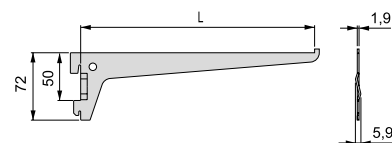

50mm

Profili di fissaggio a parete Jagmet con doppia scanalatura con passo 32 mm
Jagmet Doppelnut-Wandbefestigungsprofile mit 32 mm Abstand

Lunghezza/Längengrad	Finitura/Fertigstellung	Imballaggio/Verpackung	N° pezzi/Nr. Stücke	Cod.
0,951 m	Verniciato bianco/Weiß	1 LOTTO/Partie	10 unità/10 Einheiten	7907912
2,064 m	Verniciato bianco/Weiß	1 LOTTO/Partie	10 unità/10 Einheiten	7909412
2,229 m	Verniciato bianco/Weiß	1 LOTTO/Partie	10 unità/10 Einheiten	7909512

Acciaio/Stahl

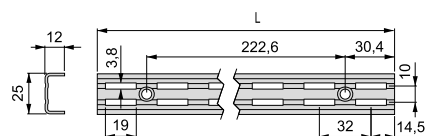

32mm

Reggipiani Jagmet a doppia scanalatura con passo 32mm
Jagmet Doppelschlitz-Wandbefestigungsprofile, 32 mm Abstand

Altezza/Höhe	Portata/Belastung	Lunghezza/Längengrad	Finitura/Fertigstellung	Imballaggio/Verpackung	N° pezzi/Nr. Stücke	Cod.
47	44	170	Verniciato bianco/Weiß	1 LOTTO/Partie	20 unità/20 Einheiten	7908512
49	34	220	Verniciato bianco/Weiß	20 UN/Einh		7908612
52	27	270	Verniciato bianco/Weiß	20 UN/Einh		7908712
58	23	320	Verniciato bianco/Weiß	1 LOTTO/Partie	20 unità/20 Einheiten	7908812
64	20	370	Verniciato bianco/Weiß	1 LOTTO/Partie	20 unità/20 Einheiten	7908912
80	16	470	Verniciato bianco/Weiß	1 LOTTO/Partie	20 unità/20 Einheiten	7909012

Acciaio/Stahl

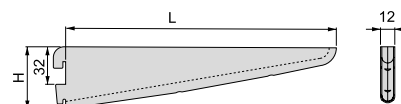

32mm

Wall fastening rails and Jagmet shelf supports
Profile mocowane do ściany i wsporniki do półek Jagmet

C	Longitude/Długość	Finishing/Wykończenie	Packaging/Opakowanie	Cod.
157	230	White painted/Malowane na biało	1 KIT/Zestaw	7026612
207	280	White painted/Malowane na biało	1 KIT/Zestaw	7026712
307	380	White painted/Malowane na biało	1 KIT/Zestaw	7026812

Steel/Stal

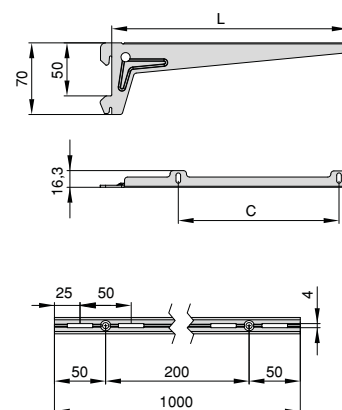

Wall fastening plates and Jagmet shelf supports
Płyty mocowane do ściany i wsporniki do półek Jagmet

C	Longitude/Długość	Finishing/Wykończenie	Packaging/Opakowanie	Cod.
157	230	White painted/Malowane na biało	1 KIT/Zestaw	7026912
207	280	White painted/Malowane na biało	1 KIT/Zestaw	7027012
307	380	White painted/Malowane na biało	1 KIT/Zestaw	7027112

Steel/Stal

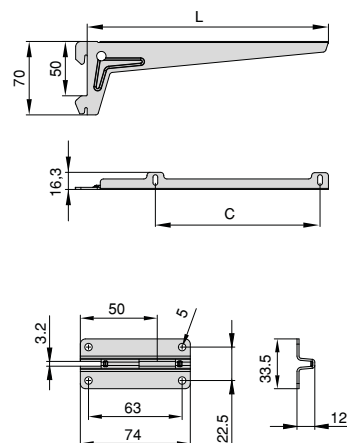

Wire baskets and Jagmet supports
Kosze druciane i wsporniki Jagmet

Finishing/Wykończenie	Packaging/Opakowanie	Cod.
White painted/Malowane na biało	1 KIT/Zestaw	7027412

Steel/Stal

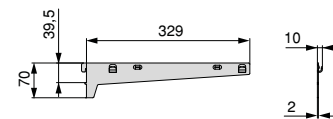
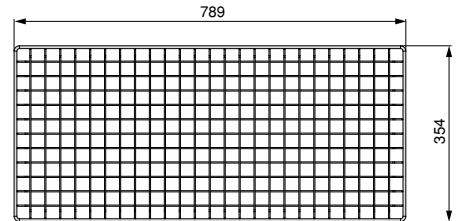

50mm 32mm

Wire shelves and Jagmet supports
Półki druciane i wsporniki Jagmet

Finishing/Wykończenie	Packaging/Opakowanie	Cod.
White painted/Malowane na biało	1 KIT/Zestaw	7027612

Steel/Stal

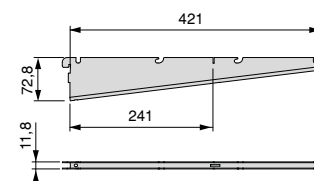
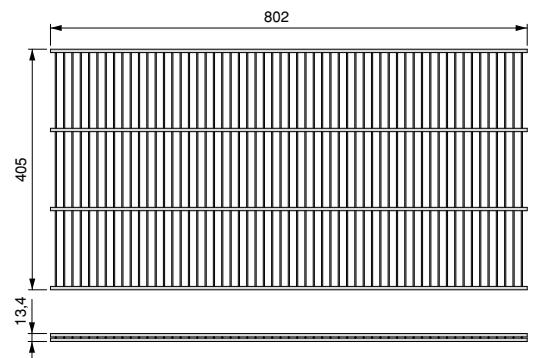
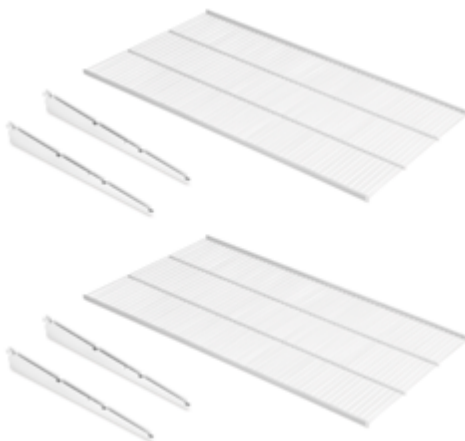

32mm

Jagmet wardrobe bars
Drażki do szafy Jagmet

Finishing/Wykończenie	Packaging/Opakowanie	Cod.
White painted/Malowane na biało	1 KIT/Zestaw	7027712

Steel/Stal

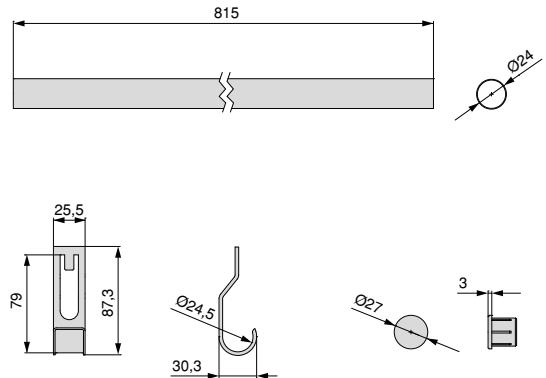

32mm

Folding coat hanger bars for a Jagmet wardrobe
Wieszaki składane Jagmet na wieszaki odzieżowe do szafy



Finishing/Wykończenie	Packaging/Opakowanie	Cod.
White painted/Malowane na biało	1 KIT/Zestaw	7027812

Steel/Stal

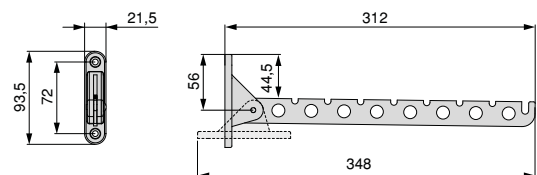

Profiles Profile

Discover our profiles designed for wardrobe doors or drawer fronts.

Odkryj nasze profile przeznaczone do drzwi szaf lub frontów szuflad.

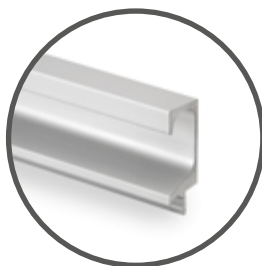

With this profile you can protect the furniture and create an area to rest your suitcases in a hotel room.

Dzięki temu profilowi możesz chronić meble i stworzyć miejsce na walizki w pokoju hotelowym.

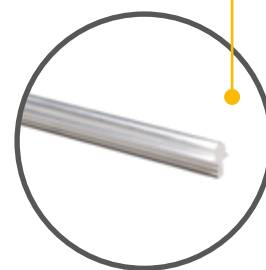

Adige vertical profile for wardrobe
Profil pionowy Adige do szaf



Longitude/Długość	Finishing/Wykończenie	Packaging/Opakowanie	Cod.
2,8 m	Matt anodized/Anodyzowany mat	10 Unit/Szt	7013462

Aluminium/Aluminium

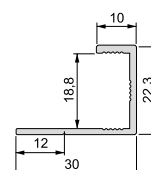
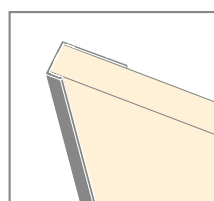

To calculate the measure to cut the board reduce 4 mm to the width of door.

Aby obliczyć wymiary płyty do wycięcia należy odjąć 4 mm od szerokości drzwi.

Adige handle profile for wardrobe
Profil uchwytyowy Adige do szaf



Longitude/Długość	Finishing/Wykończenie	Packaging/Opakowanie	Cod.
2,8 m	Matt anodized/Anodyzowany mat	10 Unit/Szt	7013262

Aluminium/Aluminium

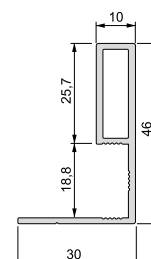
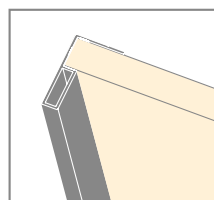

To calculate the measure to cut the board reduce 4 mm to the width of door.

Aby obliczyć wymiary płyty do wycięcia należy odjąć 4 mm od szerokości drzwi.

Free Face vertical profile for wardrobe
 Profil pionowy Free Face do szaf



Longitude/Długość	Finishing/Wykończenie	Packaging/Opakowanie	Cod.
2,9 m	Matt anodized/Anodyzowany mat	10 Unit/Szt	5872762

Aluminium/Aluminium

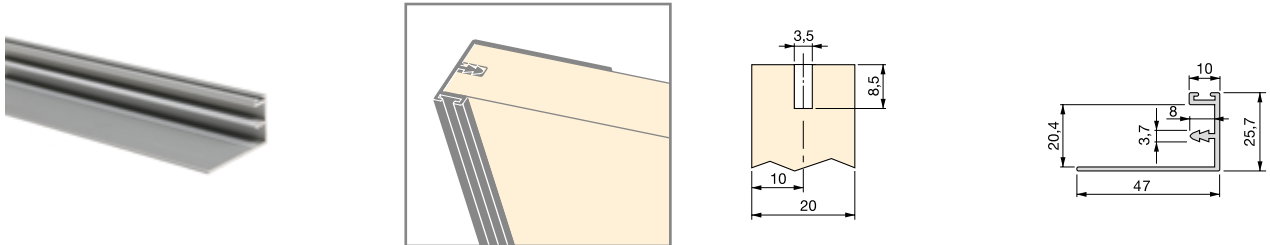

Free Face handle profile for wardrobe
 Profil uchwytowy Free Face do szaf



Longitude/Długość	Finishing/Wykończenie	Packaging/Opakowanie	Cod.
2,9 m	Matt anodized/Anodyzowany mat	10 Unit/Szt	5872862

Aluminium/Aluminium

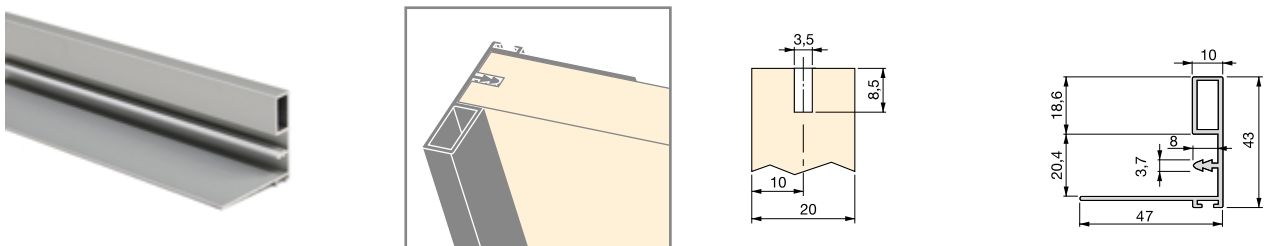

Free Face handle cover profile for wardrobe
 Profil osłony uchwytu Free Face do szaf



Longitude/Długość	Finishing/Wykończenie	Packaging/Opakowanie	Cod.
2,9 m	Matt anodized/Anodyzowany mat	5 Unit/Szt	5872962

Aluminium/Aluminium

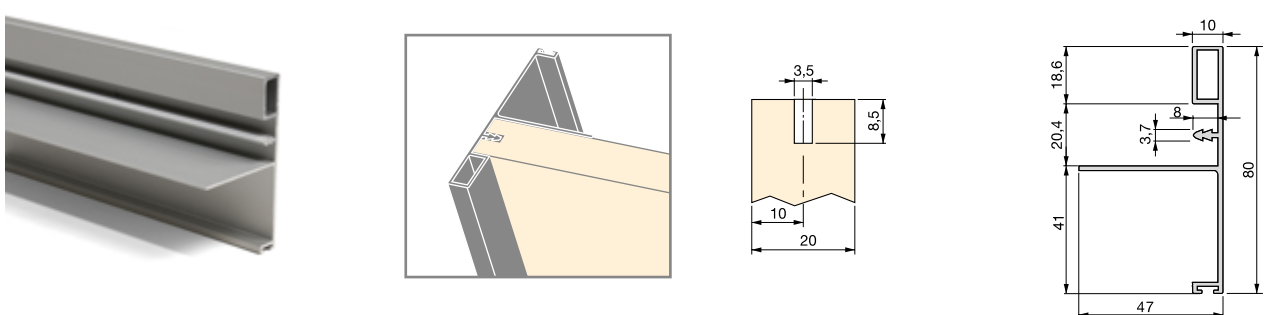

To calculate the measure to cut the board reduce 4 mm to the width of door.
 Allows the use of dustguards profiles Cod. 9045121, 9034221 and 9034121.

Aby obliczyć wymiary płyty do wycięcia należy odjąć 4 mm od szerokości drzwi.
 Umożliwia stosowanie profili osłon przeciwkurzowych kody 9045121, 9034221 i 9034121.

Free Rapid vertical profile for wardrobe
Profil pionowy Free Rapid do szaf



Longitude/Długość	Finishing/Wykończenie	Packaging/Opakowanie	Cod.
2.7 m	Matt anodized/Anodizowany mat	10 Unit/Szt	7018562

Aluminium/Aluminium

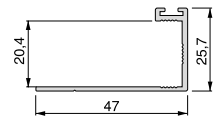
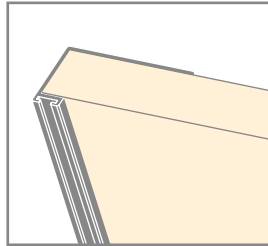

To calculate the measure to cut the board reduce 4 mm to the width of door.
 Allows the use of dustguards profiles Cod. 9045121, 9034221 and 9034121.

Aby obliczyć wymiary płyty do wycięcia należy odjąć 4 mm od szerokości drzwi.
 Umożliwia stosowanie profili osłon przeciwkurzowych kody 9045121, 9034221 i 9034121.

Free Rapid handle profile for wardrobe
Profil uchwytowy Free Rapid do szaf



Longitude/Długość	Finishing/Wykończenie	Packaging/Opakowanie	Cod.
2.7 m	Matt anodized/Anodizowany mat	10 Unit/Szt	7018362

Aluminium/Aluminium

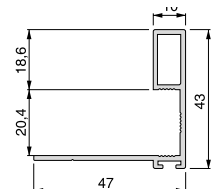
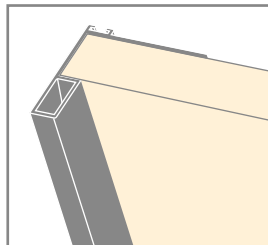

To calculate the measure to cut the board reduce 4 mm to the width of door.
 Allows the use of dustguards profiles Cod. 9045121, 9034221 and 9034121.

Aby obliczyć wymiary płyty do wycięcia należy odjąć 4 mm od szerokości drzwi.
 Umożliwia stosowanie profili osłon przeciwkurzowych kody 9045121, 9034221 i 9034121.

Styl 1 handle profile for wardrobe
Profil uchwytowy Styl do szaf



Longitude/Długość	Finishing/Wykończenie	Packaging/Opakowanie	Cod.
2.355 m	Silver painted/Malowane aluminium	10 Unit/Szt	7016125

Steel/Stal

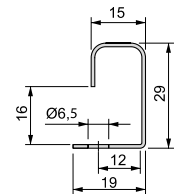
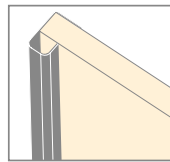

To calculate the measure to cut the board reduce 2 mm to the width of door.

Aby obliczyć wymiary płyty do wycięcia należy odjąć 2 mm od szerokości drzwi.

U Styl 1 handle profiles for wardrobe
Perfil endireitador U Styl do szaf



Longitude/Długość	Finishing/Wykończenie	Packaging/Opakowanie	Cod.
2.355 m	Silver painted/Malowane aluminium	10 Unit/Szt	7016325

Steel/Stal

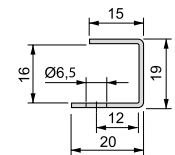
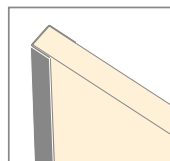

To calculate the measure to cut the board reduce 2 mm to the width of door.

Aby obliczyć wymiary płyty do wycięcia należy odjąć 2 mm od szerokości drzwi.

Profiles without adhesive dust cover for sliding door

Listwa przeciwkurzowa bez warstwy klejącej szczotka przeciwkurzowa do drzwi przesuwnych

Height/Wysokość	Longitude/Długość	Finishing/Wykończenie	Packaging/Opakowanie	Cod.
5	375 m	Grey plastic/Szary plastik	1 Unit/Szt	9045121
7	225 m	Grey plastic/Szary plastik	1 Unit/Szt	9034221
9	175 m	Grey plastic/Szary plastik	1 Unit/Szt	9034121

Plastic/Plastik

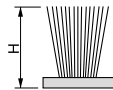

Profiles with adhesive dust cover for sliding door

Listwa przeciwkurzowa z warstwą klejącą szczotka przeciwkurzowa do drzwi przesuwnych



Height/Wysokość	Longitude/Długość	Finishing/Wykończenie	Packaging/Opakowanie	Cod.
7	400 m	Grey plastic/Szary plastik	1 Unit/Szt	9129921
9	300 m	Grey plastic/Szary plastik	1 Unit/Szt	9034321
17	125 m	Grey plastic/Szary plastik	1 Unit/Szt	9054021

Plastic/Plastik

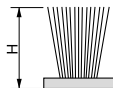
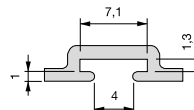

self-adhesive dust excluder for doors and windows

Samoprzylepna osłona przeciwpyłowa do drzwi i okien



Height/Wysokość	Finishing/Wykończenie	Packaging/Opakowanie	Cod.
7	Grey plastic/Szary plastik	10 m/m	7089321
9	Grey plastic/Szary plastik	10 m/m	7089421
17	Grey plastic/Szary plastik	10 m/m	7089521

Plastic/Plastik

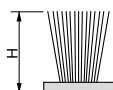
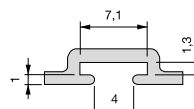

Rhodes furniture handle
Uchwyty meblowe Rhodes

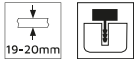

Longitude/Długość	Finishing/Wykończenie	Packaging/Opakowanie	Cod.
2,9 m	Matt anodized/Anodyzowany mat	10 Unit/Szt	9296662

Aluminium/Aluminium

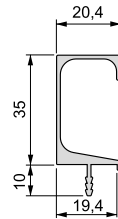
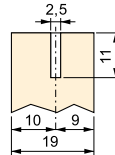
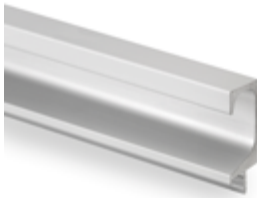

EDGING PROFILES FACE / PROFILE KRAWĘDZIOWE FACE

Profile for edges Face T
Profil narożny Face T

Longitude/Długość	Finishing/Wykończenie	Packaging/Opakowanie	Cod.
2,35 m	Matt anodized/Anodyzowany mat	50 Unit/Szt	6057762

Aluminium/Aluminium

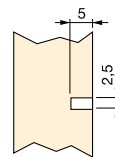

Profile for edges Wind
Profil narożny Wind

Longitude/Długość	Finishing/Wykończenie	Packaging/Opakowanie	Cod.
2,35 m	Natural aluminium/Naturalne aluminium	20 Unit/Szt	6301761

Aluminium/Aluminium

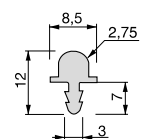
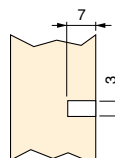

Even truss for wardrobe door
Okucie wyrównujące drzwi Even do drzwi szafy



L	M	Finishing/Wykończenie	Packaging/Opakowanie	Cod.
1.970	1.920	Matt anodized/Anodyzowany mat	25 Unit/Szt	7089662
2.290	2.240	Matt anodized/Anodyzowany mat	25 Unit/Szt	7089762

Aluminium, Plastic, Steel/Aluminium, Plastik, Stal



For the assembly, we recommend to use 2 truss per door.

Przy montażu zalecamy stosowanie 2 kratownic na drzwi.

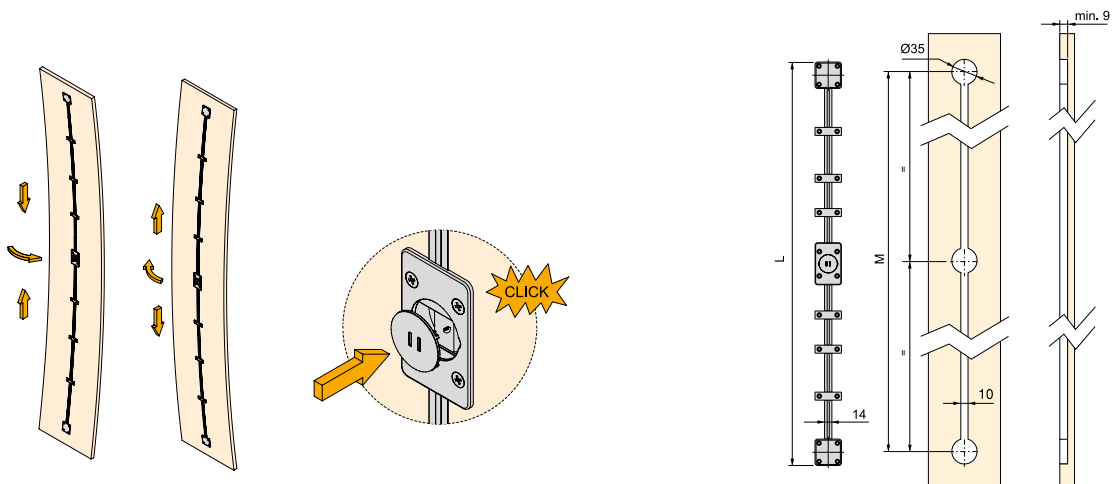

Profiles kit for making a Free wardrobe door
Zestaw profili do wykonania drzwi do szafy Free

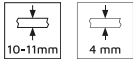

Description/Opis	Finishing/Wykończenie	Packaging/Opakowanie	Cod.
Type A/Type A	Matt anodized/Anodyzowany mat	1 Unit/Szt	7020662
Type B/Type B	Matt anodized/Anodyzowany mat	1 Unit/Szt	7020762
Type C/Type C	Matt anodized/Anodyzowany mat	1 Unit/Szt	7020862

Aluminium/Aluminium

How to calculate the door
Jak obliczyć drzwi

	2 doors wardrobe Szafa 2-drzwiowa	3 doors wardrobe Szafa 3-drzwiowa
A	$\frac{Aa + 8}{2}$	$\frac{Aa + 18}{3}$
Space +		
H	Ha + 87	

Ha-total height of the wardrobe
Ha-całkowita wysokość szafy

How to calculate the glass or chipboard
Jak obliczyć szkło lub płytę wiórową

	Glass 4 / Board 11 Szkło 4 / Płyta 11	Board 10 Płyta 10
Width Szerokość	A - 14	A - 13
Height Wysokość	$H - 5,5 - (4 \times N)$	$H - 4,5 - (3 \times N)$
	N + 1	N + 1

N = number of cross-pieces
N = liczba poprzeczek

Fittings for one door Free
Okucia do jednych drzwi Free

Description/Opis	Set/Zestaw	Finishing/Wykończenie	Packaging/Opakowanie	Cod.
Space +/Space +	1 Cross-piece/1 Profil	Not defined/Nieokreślone	1 Unit/Szt	7016820
Space +/Space +	2 Cross-pieces/2 Profil	Not defined/Nieokreślone	1 Unit/Szt	7016920
Space +/Space +	3 Cross-pieces/3 Profil	Not defined/Nieokreślone	1 Unit/Szt	7017020

Aluminium, Steel, Zamak/Aluminium, Stal, Znak

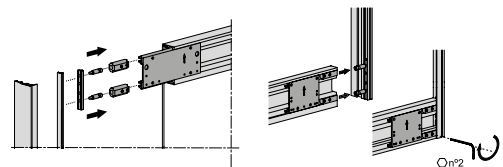

Free profiles
Profile Free

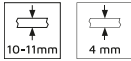

Description/Opis	Longitude/Długość	Finishing/Wykończenie	Packaging/Opakowanie	Cod.
Handle/Uchwyt	2,6 m	Matt anodized/Anodyzowany mat		12 Unit/Szt 6909462
Handle with wing/Uchwyt ze skrzydełkiem	2,6 m	Matt anodized/Anodyzowany mat		6 Unit/Szt 6909562
Vertical/Pionowy	2,6 m	Matt anodized/Anodyzowany mat		12 Unit/Szt 6909362
Upper / Bottom/Górny / dolny	2,35 m	Matt anodized/Anodyzowany mat		6 Unit/Szt 7025062
Middle profile/Profil środkowy	2,35 m	Matt anodized/Anodyzowany mat		12 Unit/Szt 7025162
Middle hidden profile/Profil środkowy	2,35 m	Matt anodized/Anodyzowany mat		12 Unit/Szt 6304262
Gasket for 4 mm glass/Uszczelka do szyby 4 mm	2,35 m	Grey plastic/Szary plastik		20 Unit/Szt 7920021

Aluminium, Plastic/Aluminium, Plastik

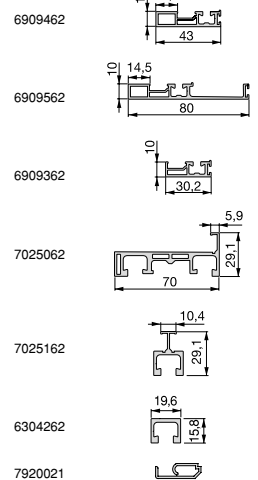
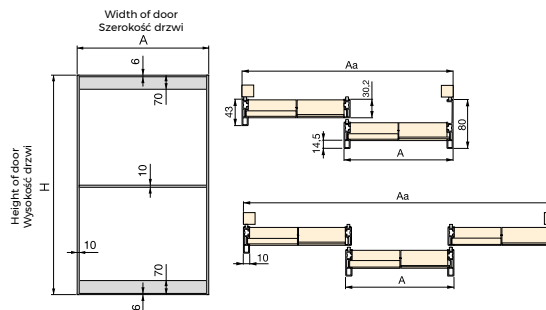
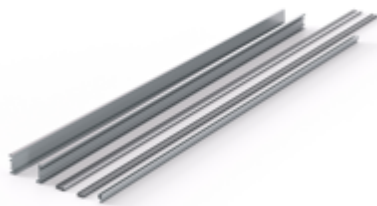

How to calculate the profiles:

Vertical = H
Horizontal = A - 20 mm

Jak obliczyć profile:

Pionowy = H
Poziomy = A - 20mm

How to calculate the door Jak obliczyć drzwi		How to calculate the glass or chipboard Jak obliczyć szkło lub płytę wiórową		
	2 doors wardrobe Szafa 2-drzwiowa	3 doors wardrobe Szafa 3-drzwiowa	Class 4 / Board 11 Szkło 4 / Płyta 11	Board 10 Płyta 10
A	$\frac{Aa + 8}{2}$	$\frac{Aa + 18}{3}$	A - 14	A - 13
H	Space + Ha + 87		$\frac{H - 5,5 - (4 \times N)}{N + 1}$	$\frac{H - 4,5 - (3 \times N)}{N + 1}$
Ha=total height of the wardrobe Ha=całkowita wysokość szafy			N = number of cross-pieces N = liczba poprzeczek	

T Link for Free wardrobe doors

Złącze T do poprzeczek Free do drzwi szafy Free

Finishing/Wykończenie	Packaging/Opakowanie	Cod.
Not defined/Nieokreślone	1 Unit/Szt	6100620

Various/Różne

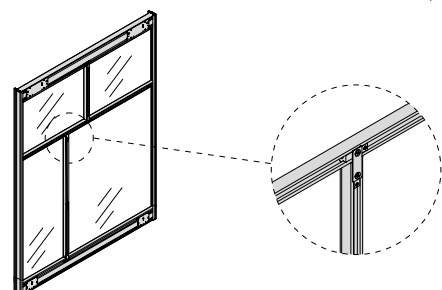

Plus profiles Profile Plus

At Emuca we are committed to black as the absolute protagonist, and for this reason, we incorporate our display cabinets in black, a colour that combines well with the whole chromatic range.

W Emuca stawiamy na czerni jako absolutnego bohatera i z tego powodu nasze gabloty są w kolorze czarnym, który dobrze łączy się z całą gamą chromatyczną.

Choose between black textured paint or matt anodised.

Do wyboru czarna teksturowana farba lub matowa anodyzacja.

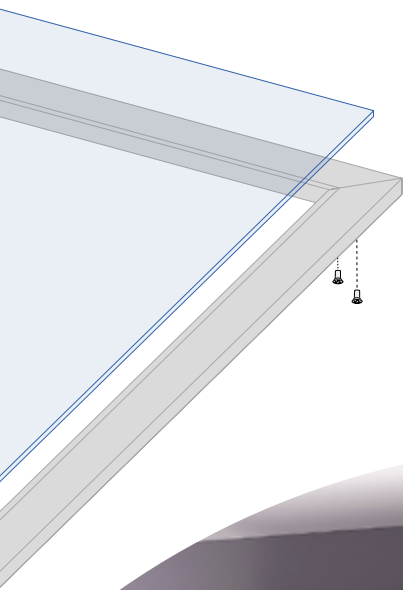
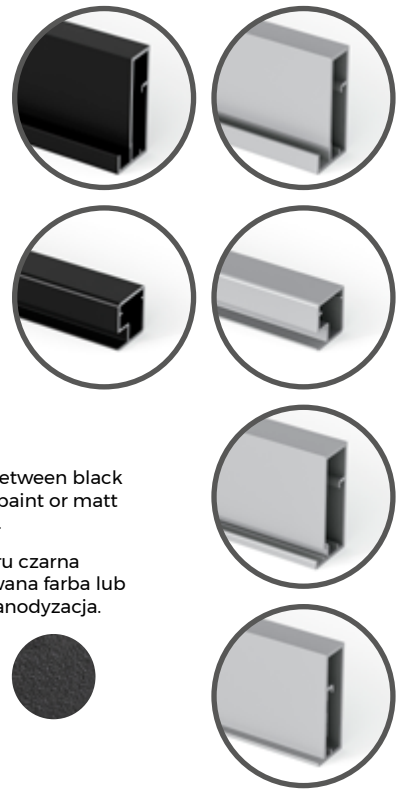





The Plus 4 and Plus 7 profiles are made of extruded aluminium, painted in textured black, which adds elegance to their timeless design.

Profile Plus 4 i Plus 7 są wykonane z wytłoczonego aluminium, pomalowanego na czarny teksturowany kolor, co dodaje elegancji ich ponadczasowemu wzornictwu.

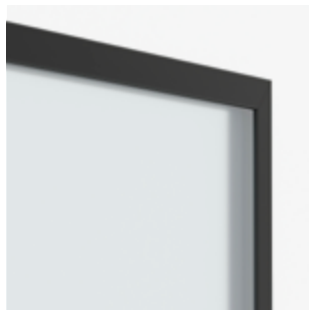
Plus





Profile for making cabinet doors Plus 4
Profil do wykonania drzwi szafy Plus 4

Longitude/Długość	Finishing/Wykończenie	Packaging/Opakowanie	Cod.
2.35 m	Textured black painted/Teksturowana czerń 	8 Unit/Szt	6304354
2.35 m	Matt anodized/Anodyzowany mat 	8 Unit/Szt	6304362

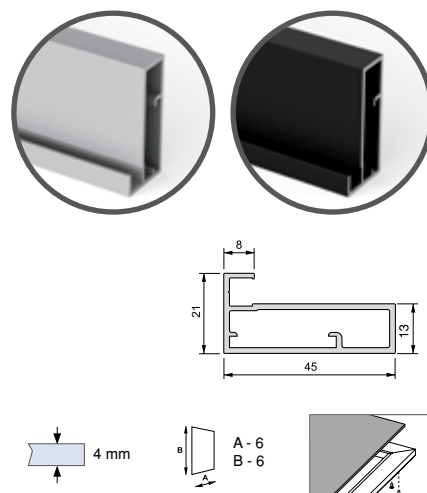
Aluminium/Aluminium



Profile for making cabinet doors Plus 7
Profil do wykonania drzwi szafy Plus 7

Longitude/Długość	Finishing/Wykończenie	Packaging/Opakowanie	Cod.
2.35 m	Textured black painted/Teksturowana czerń 	20 Unit/Szt	7025254
2.35 m	Matt anodized/Anodyzowany mat 	20 Unit/Szt	7025262

Aluminium/Aluminium

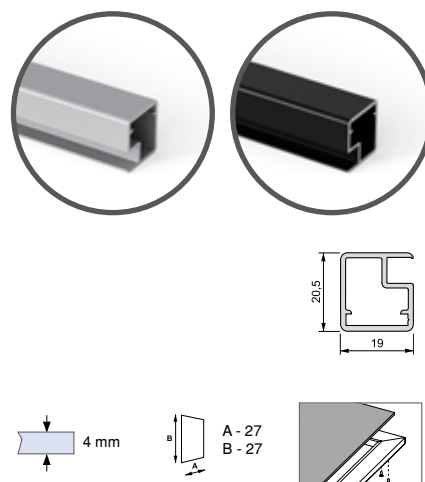

Profile for making cabinet doors Plus 11
Profil do wykonania drzwi szafy Plus 11

Longitude/Długość	Finishing/Wykończenie	Packaging/Opakowanie	Cod.
2,35 m	Matt anodized/Anodowany mat 	8 Unit/Szt	6300762

Aluminium/Aluminium

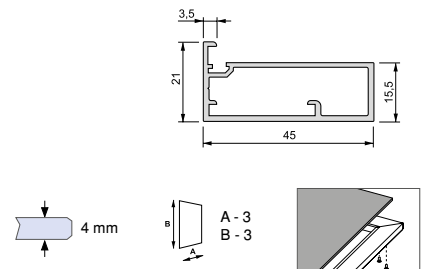
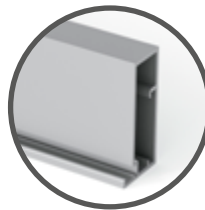

Profile for making cabinet doors Plus 14 (14+4)
Profil do wykonania drzwi szafy Plus 4 (14+4)



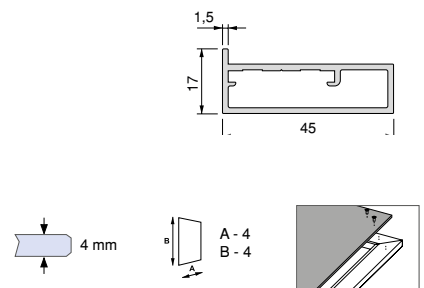
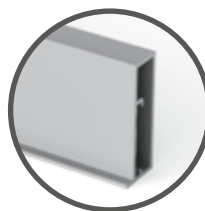

Longitude/Długość	Finishing/Wykończenie	Packaging/Opakowanie	Cod.
2,35 m	Matt anodized/Anodowany mat 	8 Unit/Szt	6304462

Aluminium/Aluminium



Gasket for Plus 4 - 7 - 18 profiles

Gałka do profilu Plus 4 - 7 - 18

Description/Opis	Longitude/Długość	Finishing/Wykończenie	Packaging/Opakowanie	Cod.
Gasket for 4 mm glass/Uszczelka do szyby 4 mm	2,35 m	Black plastic/Czarny plastik 	20 Unit/Szt	7921017
Gasket for 4 mm glass/Uszczelka do szyby 4 mm	2,35 m	Grey plastic/Szary plastik 	20 Unit/Szt	7921021

Plastic/Plastik



Gasket for Plus 11 profiles

Gałka do profilu Plus 11

Description/Opis	Longitude/Długość	Finishing/Wykończenie	Packaging/Opakowanie	Cod.
Gasket for 4 mm glass/Uszczelka do szyby 4 mm	2,35 m	Not defined/Nieokreślone 	20 Unit/Szt	7922020

Plastic/Plastik



Corners for Plus 4 - 11 - 14 - 18 profiles

Wsporniki do profilu Plus 4 - 11 - 14 - 18

Description/Opis	Finishing/Wykończenie		Packaging/Opakowanie	Cod.
Black screws/Czarne śruby	Black painted/Malowane na czarno	■	10 KIT/Zestaw	7101120
Zinc-plated screws/Śruby ocynkowane	Zinc plated/Cynkowane	■	10 KIT/Zestaw	9985520

Steel/Stal

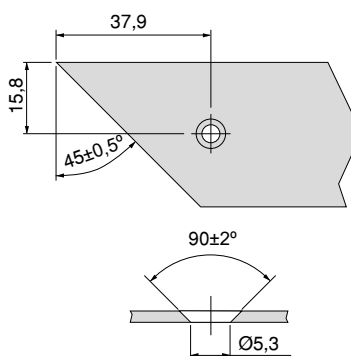

Corners for Plus 7 profiles

Wsporniki do profilu Plus 7

Description/Opis	Finishing/Wykończenie		Packaging/Opakowanie	Cod.
Black screws/Czarne śruby	Black painted/Malowane na czarno	■	10 KIT/Zestaw	7101220
Zinc-plated screws/Śruby ocynkowane	Zinc plated/Cynkowane	■	10 KIT/Zestaw	9984720

Steel/Stal

