

# Assembly / Montaż

## Certified suspended module hangers

- 544 Suspended high module hanger
- 556 Hanging bracket for suspended lower modules

## Joining systems for furniture

- 561 Ø10 assembling System
- 561 Ø10 assembling System
- 566 Ø16 assembling System
- 566 Ø16 assembling System
- 566 Ø16 assembling System
- 569 Ø15 cam & dowel
- 570 Ø15 cam & dowel
- 574 Ø25 cam & dowel
- 574 Ø25 cam & dowel
- 576 Spiral Ø35 assembling
- 577 Ø35 cam & dowel
- 577 Enganche Block System

## Wieszaki modułowe z certyfikatem

- 544 Wieszaki do modułów wysokich
- 556 Wieszak do dolnych modułów podwieszanych

## Systemy łączenia do mebli

- 561 Ø10 assembling System
- 561 Zaczepy System Ø10
- 566 Zaczepy System Ø16
- 566 Zaczepy System Ø16
- 566 Zaczepy System Ø16
- 569 Mimośrodody Ø15
- 570 Mimośrodody Ø15
- 574 Mimośrodody Ø25
- 574 Mimośrodody Ø25
- 576 Zaczep Spiral Ø35
- 577 Mimośrodody Ø35
- 577 Engates Block System

## Assembly systems

578	Catch Normal 720
578	Joint braces
580	Back panel fasteners
581	Deuvels os hout

## Joining systems for shelves

583	Catch Simply
583	Uniblock shelf supports
585	Ø20 Fix support
586	Luna support
587	Ø19 insert fastener
588	Ø25 insert fastener
589	Ø15 insert fastener

## Shelf brackets

591	Shelf support for wooden shelves
597	Shelf supports for glass

## Joining systems for walls

605	Wall shelf supports
-----	---------------------

## Screws and nuts

610	Metric screws
612	Euro screws
613	Self-tapping Allen screws
614	Self-tapping pozidrive screws
614	Sockets

## Buffers and stoppers

618	Bumpers
621	Covercaps

## Systemy montażowe

578	Zaczep Normal 720
578	Kątowniki łączące
580	Mocowania pleców
581	Kołki drewniane

## Systemy łączenia półek

583	Zaczep Simply
583	Zaczep UniBlock
585	Zaczep Fix Ø20
586	Zaczep Luna
587	Zaczep klinowy Ø19
588	Zaczep klinowy Ø25
589	Zaczep klinowy Ø15

## Wsporniki do półek

591	Wsporniki do półek szklanych
597	Wsporniki do półek szklanych

## System mocowania do ściany

605	Wsporniki do półek ściennych
-----	------------------------------

## Wkręty i nakrętki

610	Wkręty z gwintem metrycznym
612	Wkręty Euro
613	Samogwintujące się wkręty z łbem imbusowym
614	Samogwintujące się wkręty z łbem Pozidrive
614	Nakrętki

## Odbojniki i zaślepki

618	Odbojniki
621	Zaślepki

## Suspended high module hanger Wieszaki do modułów wysokich

Made-to-measure furniture is differentiated by the tendency to hang furniture on the wall. This translates into a need for specific hangers with high performance and greater load capacity. The result is our wide range of hangers designed for different needs.

Meble na wymiar wyróżniają się tendencją do wieszania ich na ścianie. Przekłada się to na zapotrzebowanie na specjalne wieszaki o wysokiej wydajności i większej nośności. Rezultatem jest nasza szeroka gama wieszaków zaprojektowanych z myślą o różnych potrzebach.

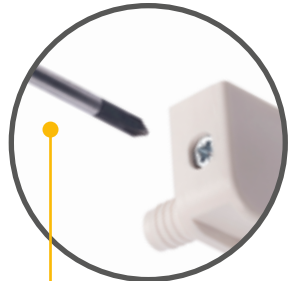
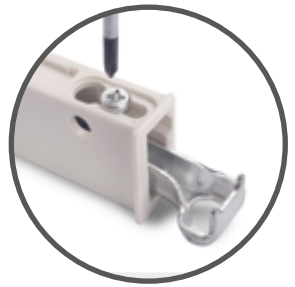

They are adjustable in height and depth to vary the position of the module once it is hung.

Posiadają one regulację wysokości i głębokości, co pozwala na zmianę pozycji modułu po jego zawieszeniu.

### KITS

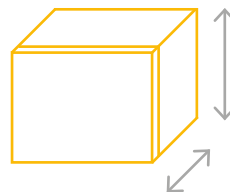

Choose the cover in anthracite grey, light grey or white.

Wybierz osłonę w kolorze szarym antracytowym, jasnoszarym lub białym.



Certified module hangers.

Certyfikowane wieszaki modułowe.

#### Holdy

2x  
65kg



±6,5 ±8,5

#### Hook

2x  
70kg



±5,5 ±6,5

#### Hover

2x  
35kg



±7 ±7,5

#### Levelup 1

2x  
65kg



±9 ±9

#### Levelup 1 anti-tilt

2x  
65kg

anti-tilt



±9 ±9

#### Levelup 2

2x  
50kg



±5,5 ±5

#### Mini

2x  
25kg



±7

The Holdy hanger fixes the furniture to the wall securely, as it can withstand 65 kg of weight. It is very easy to install as it can be adjusted 17 mm in depth, 13 mm in height and 8 mm laterally.

Wieszak Holdy bezpiecznie mocuje meble do ściany, ponieważ może wytrzymać ciężar 65 kg. Jest bardzo łatwy w montażu, ponieważ można go regulować w zakresie 17 mm na głębokość, 13 mm na wysokość i 8 mm na boki.



A plate is required to attach it to the wall.  
Do przymocowania do ściany wymagana jest płyta.

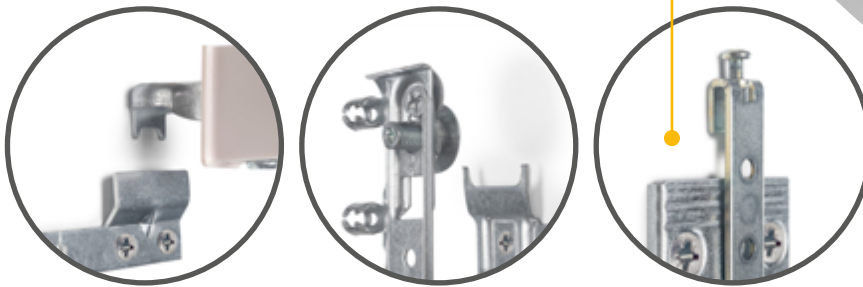















Table of compatibility between hanger and plate  
Tabela kompatybilności między wieszakiem a płytką

	 Holdy	 Hook	 Hover	 Levelup 1	 Levelup 1 anti-tilt	 Levelup 2	 Mini
 4131305	●	●	●				
 4031503	●	●	●	●			
 8918803	●	●		●			
 4030903	●			●	●		
 4031803						●	
 4032003							●

Holdy hanger for high units  
 Zawieszka typu Holdy



Description/Opis	Hand/Uchwyty	Finishing/Wykończenie	Packaging/Opakowanie	Cod.
Screw-on/Przykręcane	Right/Prawy	Zinc plated/Cynkowane	200 Unit/Szt	4342405
Screw-on/Przykręcane	Left/Lewy	Zinc plated/Cynkowane	200 Unit/Szt	4342505

Steel/Stal

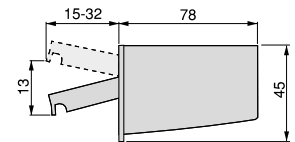
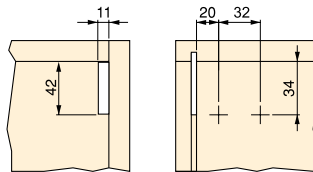

Holdy covers  
 Zaślepki do zawieszek Holdy

Hand/Uchwyty	Finishing/Wykończenie	Packaging/Opakowanie	Cod.
Right/Prawy	White plastic/Biały plastik	400 Unit/Szt	4342815
Left/Lewy	White plastic/Biały plastik	400 Unit/Szt	4342915
Right/Prawy	Grey plastic/Szary plastik	400 Unit/Szt	4342821
Left/Lewy	Grey plastic/Szary plastik	400 Unit/Szt	4342921
Right/Prawy	Anthracite grey plastic/Szaro-antracytowy plastik	400 Unit/Szt	4342823
Left/Lewy	Anthracite grey plastic/Szaro-antracytowy plastik	400 Unit/Szt	4342923

Plastic/Plastik

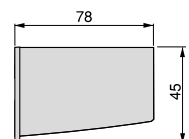

Hook hanger for high units  
 Zawieszka wbijana Hook

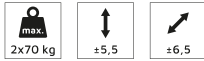

Description/Opis	Hand/Uchwyty	Finishing/Wykończenie	Packaging/Opakowanie	Cod.
Screw-on/Przykręcane	Right/Prawy	Grey plastic/Szary plastik	200 Unit/Szt	8921621
Screw-on/Przykręcane	Left/Lewy	Grey plastic/Szary plastik	200 Unit/Szt	8921521
Knock-in/Wciskane	Right/Prawy	Grey plastic/Szary plastik	200 Unit/Szt	8921421
Knock-in/Wciskane	Left/Lewy	Grey plastic/Szary plastik	200 Unit/Szt	8921321

Plastic, Steel/Plastik, Stal

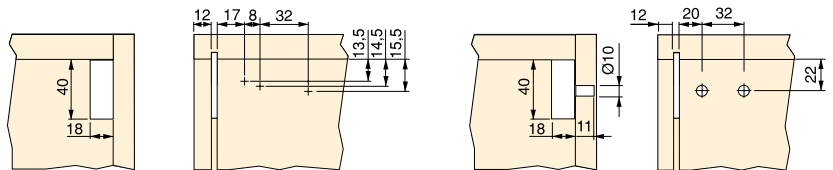
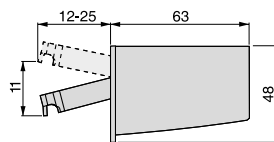

Hook covers  
 Zaślepki do zawieszek Hook

Hand/Uchwyty	Finishing/Wykończenie	Packaging/Opakowanie	Cod.
Right/Prawy	White plastic/Biały plastik	200 Unit/Szt	8921815
Left/Lewy	White plastic/Biały plastik	200 Unit/Szt	8921715
Right/Prawy	Grey plastic/Szary plastik	200 Unit/Szt	8921821
Left/Lewy	Grey plastic/Szary plastik	200 Unit/Szt	8921721
Right/Prawy	Anthracite grey/Szary antracyt	200 Unit/Szt	8921835
Left/Lewy	Anthracite grey/Szary antracyt	200 Unit/Szt	8921735

Plastic/Plastik

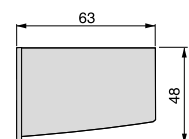

Hook hanger set for wardrobes with plate and covers  
 Zestaw haczyków do szafy Hook z klipsami i osłonami



Finishing/Wykończenie	Packaging/Opakowanie	Cod.
Grey plastic/Szary plastik	5 KIT/Zestaw	4032221

Plastic, Steel/Plastik, Stal

**KITS**

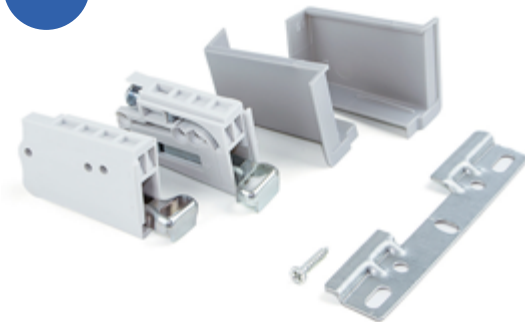

- Includes:
- 8921521 hanger for left bolt-on.
  - 8921621 hanger to screw right.
  - 8921721 grey cover left.
  - 8921821 grey cover right.
  - 8918803 double plate.
  - Screws 3,5x25mm.

- Zawiera:
- 8921521 wieszak do przykręcenia z lewej strony.
  - 8921621 wieszak do przykręcenia z prawej strony.
  - 8921721 szara pokrywa lewa.
  - 8921821 szara pokrywa prawa.
  - 8918803 podwójna płyta.
  - Śruby 3,5x25 mm.

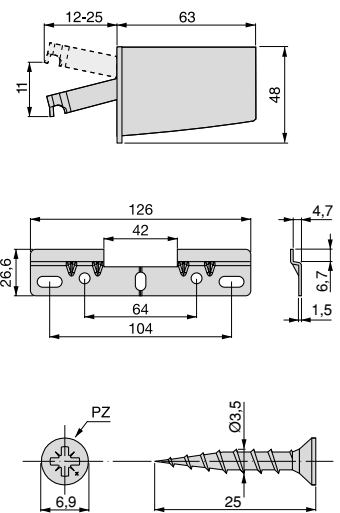
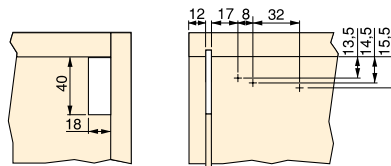

Hanging profile for tall modules  
 Profil do zawieszania wysokich modułów

Longitude/Długość	Finishing/Wykończenie	Packaging/Opakowanie	Cod.
2 m	Zinc plated/Cynkowane	10 Unit/Szt	4131305

Steel/Stal

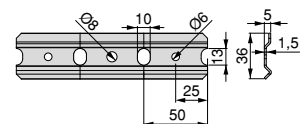

Hanger for tall modules Hover  
 Wieszak do modułów wysokich Hover



Description/Opis	Hand/Uchwyty	Finishing/Wykończenie	Packaging/Opakowanie	Cod.
Knock-in/Wciskane	Right/Prawy	White plastic/Biały plastik	250 Unit/Szt	4031115
Knock-in/Wciskane	Left/Lewy	White plastic/Biały plastik	250 Unit/Szt	4031215
Screw-on/Przykręcane	Right/Prawy	White plastic/Biały plastik	250 Unit/Szt	4031315
Screw-on/Przykręcane	Left/Lewy	White plastic/Biały plastik	250 Unit/Szt	4031415

Plastic, Steel/Plastik, Stal

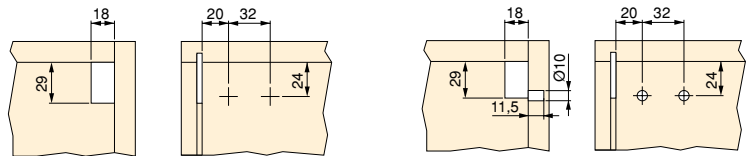
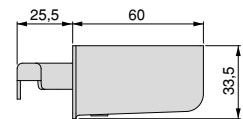

Hover high module double plate  
 Hover Podwójna płyta o wysokim module

Finishing/Wykończenie	Packaging/Opakowanie	Cod.
Natural steel/Naturalna stal	500 Unit/Szt	4031503

Steel/Stal

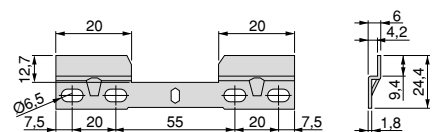



## Suspended high module hanger Wieszaki do modułów wysokich

Levelup hangers are attached to the wall by means of a plate and are hidden from view once mounted on the furniture.

Wieszaki Levelup są mocowane do ściany za pomocą płytki i są niewidoczne po zamontowaniu na meblach.

### KITS

The version with an anti-tilt system prevents unintentional unhooking of the module.

Wersja z systemem antyprzechyleniowym zapobiega przypadkowemu odłączeniu modułu.

anti-tilt

They have a load capacity of up to 65 kg, height adjustment of 18 mm and depth adjustment of 18 mm. They are manufactured in accordance with UNE-EN 15939 standard.

Mają nośność do 65 kg, regulację wysokości w zakresie 18 mm i regulację głębokości w zakresie 18 mm. Są produkowane zgodnie z normą UNE-EN 15939.

2x  
65kg

±9 ±9

Levelup 1 hanger for high units  
 Zawieszka Levelup

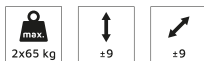

Hand/Uchwyt	Finishing/Wykończenie	Packaging/Opakowanie	Cod.
Right/Prawy	Zinc plated/Cynkowane	100 Unit/Szt	8918605
Left/Lewy	Zinc plated/Cynkowane	100 Unit/Szt	8918705

Steel/Stal

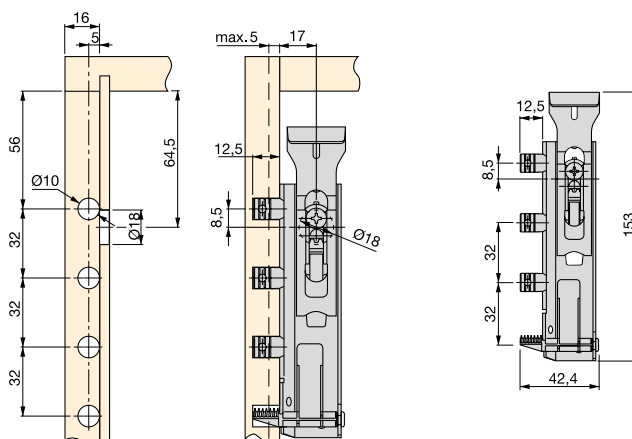

Double platen  
 Podwójna płyta

Finishing/Wykończenie	Packaging/Opakowanie	Cod.
Natural steel/Naturalna stal	200 Unit/Szt	8918803

Steel/Stal

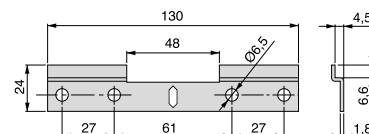

Levelup1 hanger set for wardrobes with plate  
 Zestaw wieszaków do szafy Levelup1 z zatraskowymi półkami

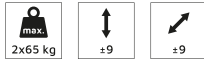

Finishing/Wykończenie	Packaging/Opakowanie	Cod.
Zinc plated/Cynkowane	5 KIT/Zestaw	4032305

Steel/Stal

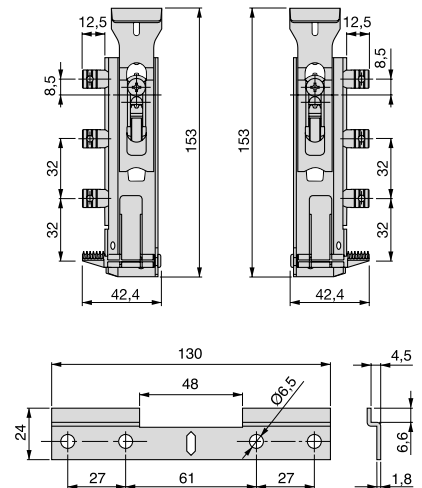
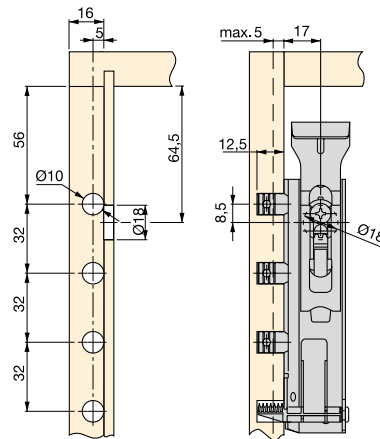

- Includes:
- 8918705 left hanger.
  - 8918605 right hanger.
  - 8918803 double hanger.

- Zawiera:
- 8918705 lewy wieszak.
  - 8918605 prawy wieszak.
  - 8918803 podwójny wieszak.

Levelup 1 cover  
 Zatyczka do ukrytych wysokich modułów Levelup 1

Finishing/Wykończenie	Packaging/Opakowanie	Cod.
Nickel plated/Niklowane	1000 Unit/Szt	8918907
White plastic/Biały plastik	1000 Unit/Szt	8918915

Plastic, Zamak/Plastik, Znal

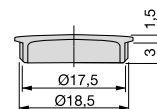

Hanger for tall modules with Levelup 1 anti-tilt system  
 Wieszak do modułów wysokich z systemem antyprzechyleniowym Levelup 1



Hand/Uchwyt	Finishing/Wykończenie	Packaging/Opakowanie	Cod.
Right/Prawy	Zinc plated/Cynkowane	100 Unit/Szt	4030705
Left/Lewy	Zinc plated/Cynkowane	100 Unit/Szt	4030805

Steel/Stal

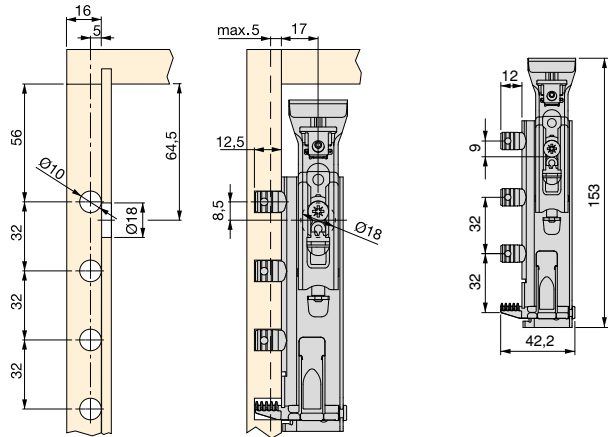

Anti-tip plate for tall modules Levelup 1  
 Płyta przeciwywrotna do wysokich modułów Levelup 1

Finishing/Wykończenie	Packaging/Opakowanie	Cod.
Natural steel/Naturalna stal	100 Unit/Szt	4030903

Steel/Stal

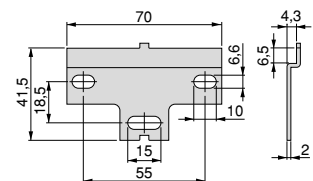

Concealed hanger for tall units Levelup 2  
 Ukryty wieszak do wysokich jednostek Levelup 2



Hand/Uchwyt	Finishing/Wykończenie	Packaging/Opakowanie	Cod.
Right/Prawy	Zinc plated/Cynkowane	100 Unit/Szt	4031605
Left/Lewy	Zinc plated/Cynkowane	100 Unit/Szt	4031705

Steel, Zamak/Stal, Znal

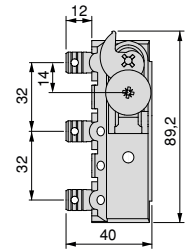
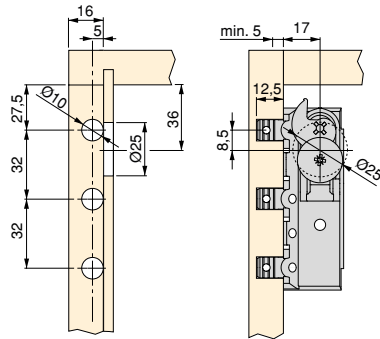

Levelup 2 double high module plate  
 Płyta modułowa Levelup 2 o podwójnej wysokości

Finishing/Wykończenie	Packaging/Opakowanie	Cod.
Natural steel/Naturalna stal	250 Unit/Szt	4031803

Steel/Stal

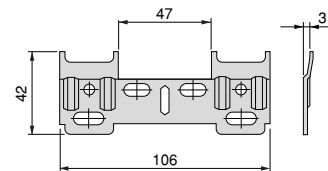

Hanger for tall modules Mini  
 Wieszak do wysokich modułów Mini



Finishing/Wykończenie	Packaging/Opakowanie	Cod.
Zinc plated/Cynkowane	500 Unit/Szt	4031905

Steel/Stal

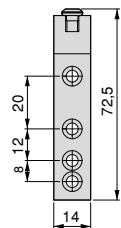

Mini high module plate  
 Mini płyta modułowa wysoka

Finishing/Wykończenie	Packaging/Opakowanie	Cod.
Natural steel/Naturalna stal	500 Unit/Szt	4032003

Steel/Stal

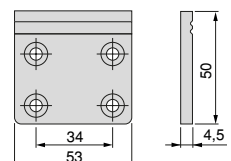

## Hanging bracket for suspended lower modules Wieszak do dolnych modułów podwieszanych

The Strong hanger is designed for suspended base units, withstands heavy loads and includes vertical, horizontal and depth adjustment.

Wieszak Strong jest przeznaczony do podwieszanych modułów dolnych, wytrzymuje duże obciążenia i obejmuje regulację w pionie, poziomie i głębokości.

**120kg**

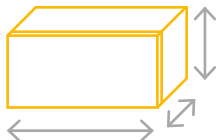

Nominal load capacity of 120 kg per hanger, according to EN 15939.

Nominalna nośność wynosi 120 kg na wieszak, zgodnie z normą EN 15939.

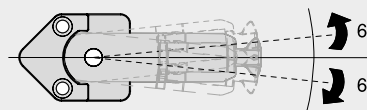
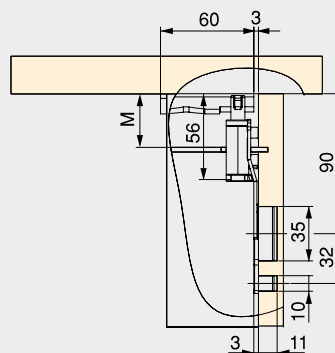



There are two types of bottom brackets, one for mounting the cabinet at a distance of 32 mm from the wall and another model at a distance of 3 mm.

Dostępne są dwa rodzaje wsporników dolnych, jeden do montażu szafki w odległości 32 mm od ściany i drugi model w odległości 3 mm.

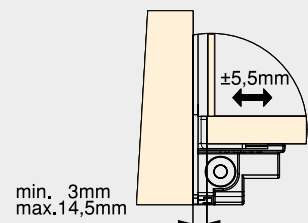
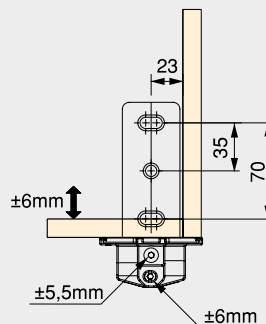
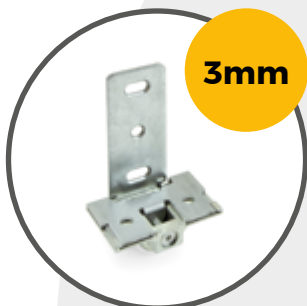
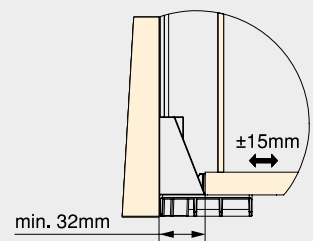
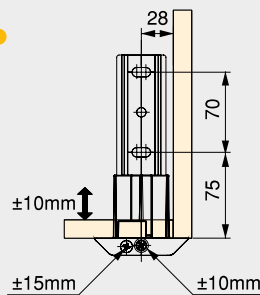



**Strong hanger for high units**  
**Wytrzymała zawieszka**



Finishing/Wykończenie	Packaging/Opakowanie	Cod.
Zinc plated/Cynkowane	50 Unit/Szt	4347105

Steel/Stal

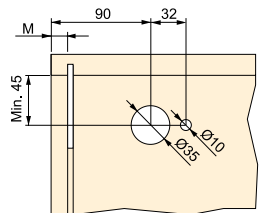
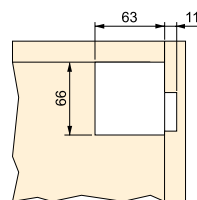
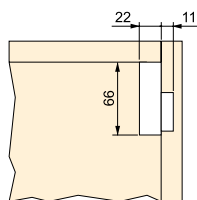
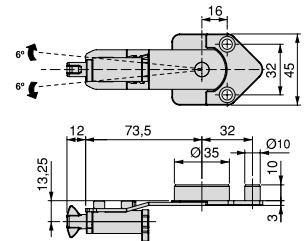

**Strong plate for suspended Strong bottom modules**  
**Wytrzymała płyta**



Finishing/Wykończenie	Packaging/Opakowanie	Cod.
Zinc plated/Cynkowane	100 Unit/Szt	4347205

Steel/Stal

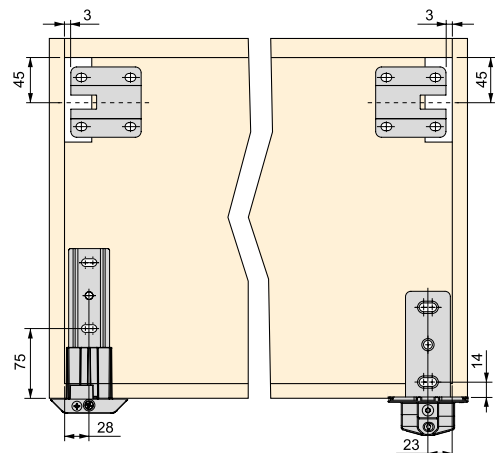
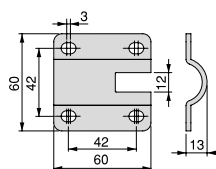

Bottom fix support for suspended lower modules Strong 32 mm  
 Wytrzymały, 32-milimetrowy wspornik mocowania od dołu

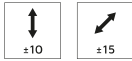

Finishing/Wykończenie	Packaging/Opakowanie	Cod.
Zinc plated/Cynkowane	25 Unit/Szt	4347305

Steel/Stal

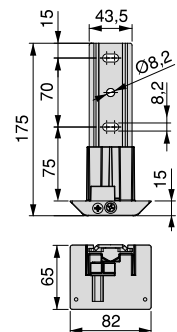

32mm

Bottom fix support for suspended lower modules Strong 3 mm  
 Wytrzymały, 3-milimetrowy wspornik mocowania od dołu

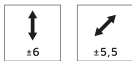

Finishing/Wykończenie	Packaging/Opakowanie	Cod.
Zinc plated/Cynkowane	25 Unit/Szt	4347405

Steel/Stal

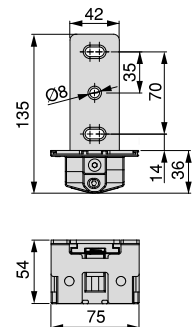

3mm

## Joining systems for furniture Systemy łączenia do mebli

These fastening systems are designed for furniture, wardrobe frames and bed or table connections.

Te systemy łączenia są przeznaczone do mebli, ram szaf i połączeń łóżek lub stołów.

### KITS

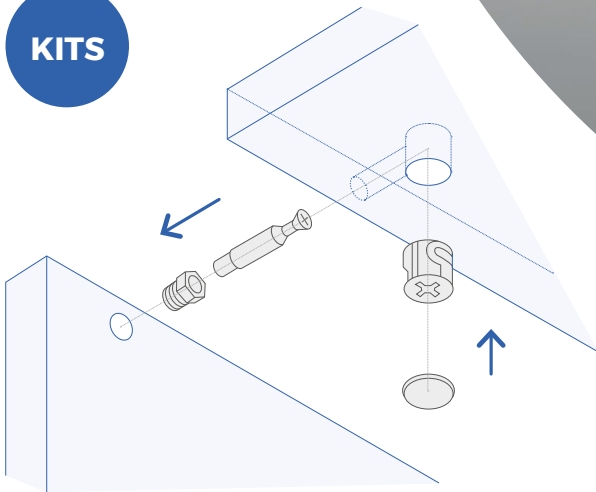

They are characterised by their strong and effective fastening for robust joints, providing a removable fixing.

Charakteryzują się mocnym i skutecznym mocowaniem do solidnych połączeń, zapewniając zdejmowane mocowanie.



Catch Rostro  
Zaczepek Rostro



Assembling System  
Zaczepek System

Ø10



Ø14



Ø15



Ø16



Eccentrics  
Mimośrodny

Ø12



Ø15



Ø25



Ø35



Ø35



Ø35



**Catch Rostro**  
**Zaczep Rostro**

Finishing/Wykończenie	Packaging/Opakowanie	Cod.
Natural zamak/Znal naturalny	250 Unit/Szt	4010401

Zamak/Znal

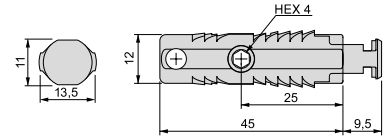
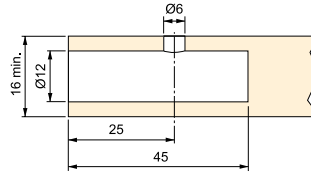

**Zamak socket**  
**Mufa znalowa**

Finishing/Wykończenie	Packaging/Opakowanie	Cod.
Natural zamak/Znal naturalny	250 Unit/Szt	4010601

Zamak/Znal

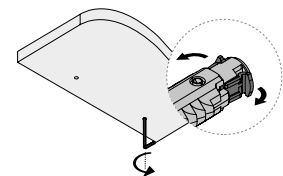
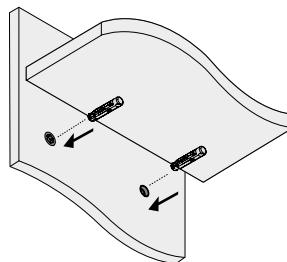
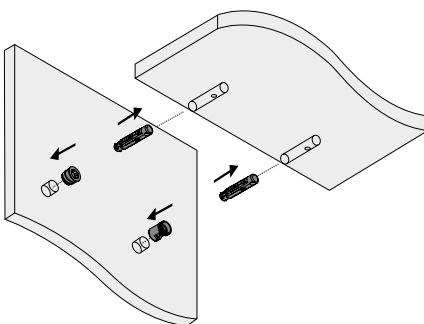
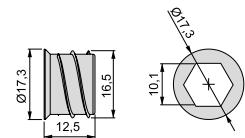
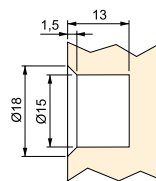

Housings for System coupling Ø10  
 Tłok do zaczepru klinowego System Ø10

Board thickness/Gru- bości płyty	X	Y	Finishing/Wykończenie	Packaging/Opakowanie	Cod.
14	7	12.5	Zinc plated/Cynkowane	2000 Unit/Szt	8012605
16	8	14	Zinc plated/Cynkowane	2000 Unit/Szt	8012505
18	9	15	Zinc plated/Cynkowane	2000 Unit/Szt	8012405
14	7	12.5	Black zinc plated/Cynkowana czerni	2000 Unit/Szt	8012609
16	8	14	Black zinc plated/Cynkowana czerni	2000 Unit/Szt	8012509
18	9	15	Black zinc plated/Cynkowana czerni	2000 Unit/Szt	8012409

Steel/Stal

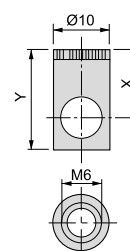

Conical screws for System coupling Ø10  
 Śruba stożkowa do zaczepru klinowego System Ø10

Head/Leb śruby	Board thickness/Gru- bości płyty	X	Finishing/Wykończenie	Packaging/Opakowanie	Cod.
Allen 3/Allen 3	12	6	Zinc plated/Cynkowane	500 Unit/Szt	5129305
PZ-2/PZ-2	14-16-18-22-26	8	Zinc plated/Cynkowane	2000 Unit/Szt	8010305
Allen 3/Allen 3	14-16-18-22-26	8	Black zinc plated/Cynkowana czerni	2000 Unit/Szt	7009009

Steel/Stal

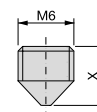

Bolt for System coupling Ø10  
 Śruba do zaczepru klinowego System Ø10

A	B	Diametre/Sred- nica	Z	F	Finishing/Wykończenie	Packaging/ Opakowanie	Cod.
18,5	26	7	9	EU M6	Zinc plated/Cynkowane	1000 Unit/Szt	8013005
28,5	36	7	9	EU M6	Zinc plated/Cynkowane	1000 Unit/Szt	8012805

Steel/Stal

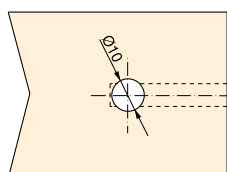

A	A <sub>1</sub>
15,5	20
20	21,5
28,5	30
30	31,5

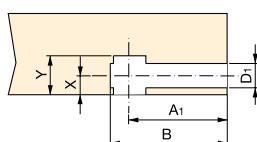

Ø	D <sub>1</sub>
6	Ø6,5
7	Ø7,5

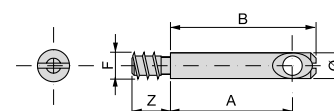

Double bolts for System coupling Ø10  
 Podwójny Trzpień do zaczepu klinowego System Ø10

Finishing/Wykończenie	Packaging/Opakowanie	Cod.
Zinc plated/Cynkowane	1000 Unit/Szt	5232305

Steel/Stal

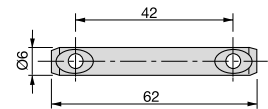
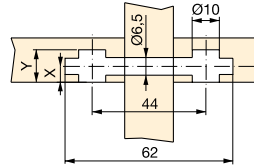

90° double bolts for System coupling Ø10  
 Podwójny Trzpień 90° do zaczepu klinowego System Ø10

Finishing/Wykończenie	Packaging/Opakowanie	Cod.
Zinc plated/Cynkowane	1000 Unit/Szt	5136405

Steel/Stal

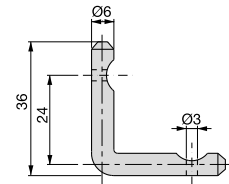
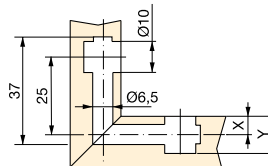

Articulated double bolts for System coupling Ø10  
 Podwójny Trzpień przegubowy do zaczepu klinowego System Ø10

Finishing/Wykończenie	Packaging/Opakowanie	Cod.
Zinc plated/Cynkowane	500 Unit/Szt	5012205

Steel/Stal

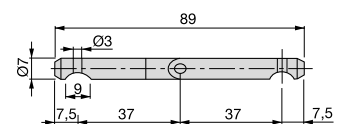
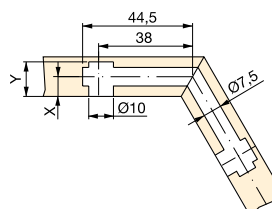

Housings for System coupling Ø14  
 Tłok do zaczeu klinowego System Ø14

Board thickness/Cru- bość płyty	X	Y	F	Finishing/Wykończenie	Packaging/Opakowa- nie	Cod.
16	8	14	EU M8x1	Zinc plated/Cynkowane	1000 Unit/Szt	8010605
18	9	14.5	EU M8x1	Zinc plated/Cynkowane	1000 Unit/Szt	4435105
18	9	14.5	EU M8	Zinc plated/Cynkowane	1000 Unit/Szt	4417205
20	10	15.5	EU M8x1	Zinc plated/Cynkowane	1000 Unit/Szt	8035005

Zamak/Znal

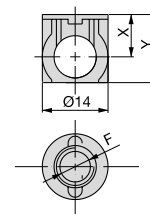

Housings with cover rim for System coupling Ø14  
 Tłok z pierścieniem do zaczeu klinowego System Ø14

Board thickness/Cru- bość płyty	X	Y	F	Finishing/Wykończenie	Packaging/Opakowa- nie	Cod.
18	9	14.5	EU M8x1	Zinc plated/Cynkowane	1000 Unit/Szt	4434905
18	9	14.5	EU M8	Zinc plated/Cynkowane	1000 Unit/Szt	4417005

Zamak/Znal

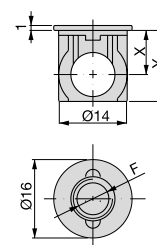

Conical screws for System coupling Ø14  
 Śruba stożkowa do zaczepu klinowego System Ø14

Board thickness/Grubość płyty	X	F	Finishing/Wykończenie	Packaging/Opakowanie	Cod.
14-16-18	8.5	EU M8x1	Zinc plated/Cynkowane	1000 Unit/Szt	8146105
18	8.5	EU M8	Zinc plated/Cynkowane	1000 Unit/Szt	8146205
20	10	EU M8x1	Zinc plated/Cynkowane	1000 Unit/Szt	8111805
22	10	EU M8	Zinc plated/Cynkowane	1000 Unit/Szt	8111905

Steel/Stal

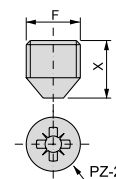

Conical screws for System coupling Ø14  
 Wkręt do zaczepu klinowego System Ø14

Board thickness/Grubość płyty	X	F	Finishing/Wykończenie	Packaging/Opakowanie	Cod.
18	10	EU M8	Zinc plated/Cynkowane	1000 Unit/Szt	8069005

Zamak/Znal

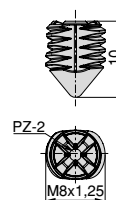

Bolt  
 Śruba

A	B	Diametre/Średnica	Z	F	Finishing/Wykończenie	Packaging/Opakowanie	Cod.
20	27	7	9	EU M6	Zinc plated/Cynkowane	1000 Unit/Szt	8012905
30	36	7	9	EU M6	Zinc plated/Cynkowane	1000 Unit/Szt	8012705

Steel/Stal

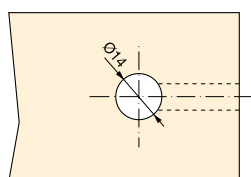

A	A <sub>1</sub>
18,5	20
20	21,5
28,5	30
30	31,5

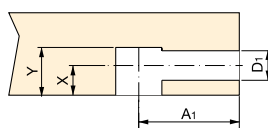
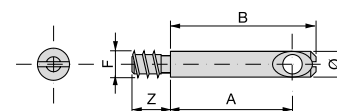

Ø	D <sub>1</sub>
7	Ø7,5
8	Ø8,5



Double bolts for System coupling Ø14  
 Podwójny Trzpień do zaczepu klinowego System Ø14

Finishing/Wykończenie	Packaging/Opakowanie	Cod.
Zinc plated/Cynkowane 	500 Unit/Szt	8410805

Steel/Stal

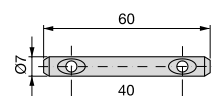
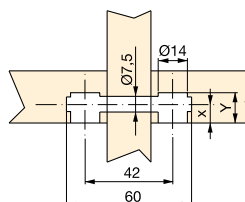

90° double bolts for System coupling Ø14  
 Podwójny Trzpień 90° do zaczepu klinowego System Ø14

Finishing/Wykończenie	Packaging/Opakowanie	Cod.
Zinc plated/Cynkowane 	250 Unit/Szt	8011705

Steel/Stal

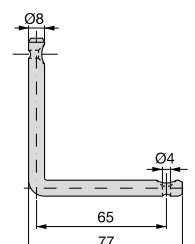
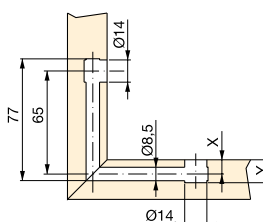

Drill-hole covercaps  
 Zaślepki otworów

Finishing/Wykończenie	Packaging/Opakowanie	Cod.
White plastic/Biały plastik 	1000 Unit/Szt	9010715

Plastic/Plastik

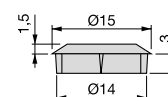

Housings for System coupling Ø15  
 Tłok do zaczeu klinowego System Ø15

Board thickness/Grubość płyty	X	Y	Finishing/Wykończenie	Packaging/Opakowanie	Cod.
18	9	14	Zinc plated/Cynkowane	1000 Unit/Szt	4205205

Zamak/Znal

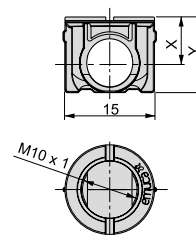

Conical screw for System coupling Ø15  
 Wkręt do zaczeu klinowego System Ø15

Board thickness/Grubość płyty	Finishing/Wykończenie	Packaging/Opakowanie	Cod.
16 - 18	Zinc plated/Cynkowane	1000 Unit/Szt	4134105

Zamak/Znal

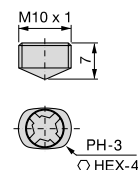

Bolt  
 Śruba

Z	F	Finishing/Wykończenie	Packaging/Opakowanie	Cod.
8	M6	Zinc plated/Cynkowane	1000 Unit/Szt	8004805

Zamak/Znal

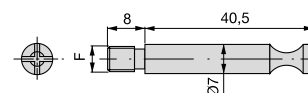
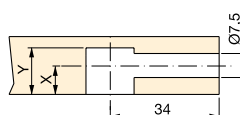
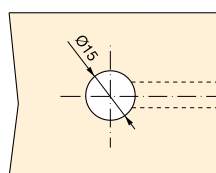

Housings for System coupling Ø16  
 Obudowy do zaczepu klinowego System Ø16

Board thickness/Grubość płyty	X	Y	Finishing/Wykończenie	Packaging/Opakowanie	Cod.
22	11	18	Zinc plated/Cynkowane	1000 Unit/Szt	8033905
25	12.5	20	Zinc plated/Cynkowane	1000 Unit/Szt	8033805

Zamak/Znal

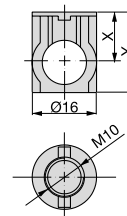

Housings for System coupling Ø16 with cover rim  
 Obudowa z pokrywą System Ø16

Board thickness/Grubość płyty	X	Y	Finishing/Wykończenie	Packaging/Opakowanie	Cod.
25	12.5	20	Zinc plated/Cynkowane	1000 Unit/Szt	8033605

Zamak/Znal

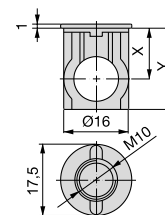

Conical screws for System coupling Ø16  
 Śruba stożkowa do zaczepu klinowego System Ø16

Head/Leb śruby	Board thickness/Grubość płyty	X	Finishing/Wykończenie	Packaging/Opakowanie	Cod.
PH-2/PH-2	22	12	Zinc plated/Cynkowane	1000 Unit/Szt	8069305

Zamak/Znal

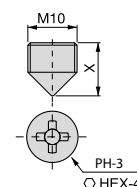

Conical screws for System coupling Ø16  
 Śruba stożkowa do zaczepu klinowego System Ø16

Head/Leb śruby	Board thickness/C grubość płyty	X	Finishing/Wykończenie	Packaging/Opakowanie	Cod.
PH-2/PH-2	25	13	Zinc plated/Cynkowane	1000 Unit/Szt	8209805

Steel/Stal

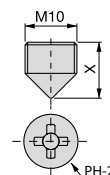

Bolt for System coupling Ø16  
 Trzpień do zaczepu klinowego System Ø16

A	B	Z	F	Finishing/Wykończenie	Packaging/Opakowanie	Cod.
20	27	9	M6	Zinc plated/Cynkowane	1000 Unit/Szt	8009305
20	27	10	M8	Zinc plated/Cynkowane	1000 Unit/Szt	8009105
30	37	9	M6	Zinc plated/Cynkowane	1000 Unit/Szt	8008905
30	37	9	M8	Zinc plated/Cynkowane	1000 Unit/Szt	8009005

Steel/Stal

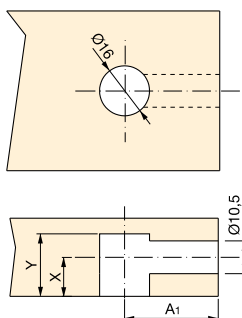

A	A <sub>1</sub>
20	21,5
30	31,5

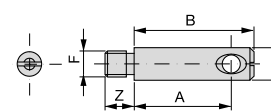

**Double bolts for System coupling Ø16**  
**Podwójny Trzpień do zaczepu klinowego System Ø16**

Finishing/Wykończenie	Packaging/Opakowanie	Cod.
Zinc plated/Cynkowane 	250 Unit/Szt	8009605

Steel/Stal

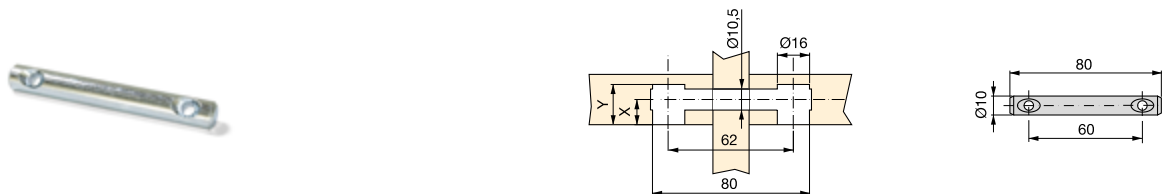

**90° double bolts for System coupling Ø16**  
**Podwójny Trzpień 90° do zaczepu klinowego System Ø16**

Finishing/Wykończenie	Packaging/Opakowanie	Cod.
Zinc plated/Cynkowane 	200 Unit/Szt	8009505

Steel/Stal

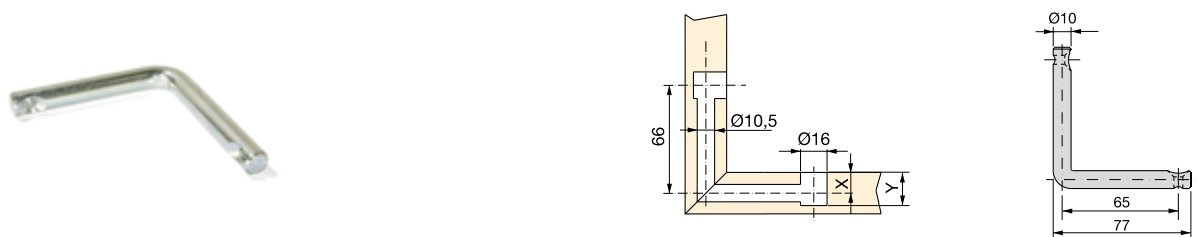

**Drill-hole covercaps for System coupling Ø16**  
**Korek wiertniczy do zaczepu klinowego System Ø16**

Finishing/Wykończenie	Packaging/Opakowanie	Cod.
White plastic/Biały plastik 	1000 Unit/Szt	9009715

Plastic/Plastik



**T12 Cam**  
**Mimośród**

Board thickness/Grubość płyty	Finishing/Wykończenie	Packaging/Opakowanie	Cod.
12	Zinc plated/Cynkowane	2500 Unit/Szt	8010005

Zamak/Znal

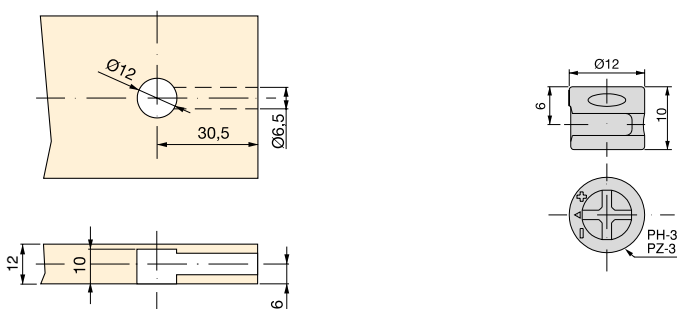

**Bolt for Eccentric**  
**Trzpień do mimośrodków**

Finishing/Wykończenie	Packaging/Opakowanie	Cod.
Natural zamak/Znal naturalny	2500 Unit/Szt	5034501

Zamak/Znal

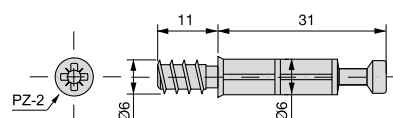

T15 of Ø15 Cam  
 Excêntrica/Mimośród 15 / 16 / 19

Board thickness/Grubość płyty	X	Y	Finishing/Wykończenie	Packaging/Opakowanie	Cod.
15	7,5	12	Natural zamak/Znal naturalny	2500 Unit/Szt	4358601
16	8	12,5	Natural zamak/Znal naturalny	2500 Unit/Szt	4431101
19	9,5	14	Natural zamak/Znal naturalny	2500 Unit/Szt	4406901
16	8	12,5	Zinc plated/Cynkowane	2500 Unit/Szt	4431105
19	9,5	14	Zinc plated/Cynkowane	2500 Unit/Szt	4406905
19	9,5	14	Nickel plated/Niklowane	2500 Unit/Szt	4406907
16	8	12,5	Nickel plated/Niklowane	2500 Unit/Szt	4431107

Zamak/Znal

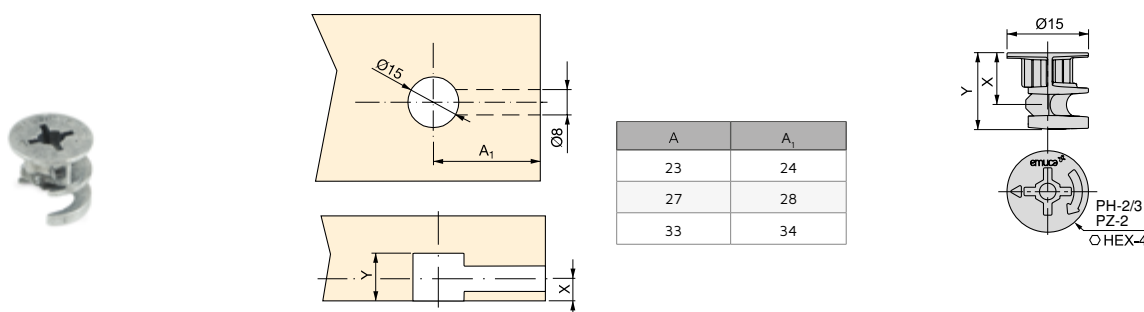

T15 Cams and dowels kit with bolts, Ø 6 mm  
 T15 Zestaw krzywek i kołków z trzpieniami, Ø 6 mm

Board thickness/Grubość płyty	X	Y	Z	F	Finishing/Wykończenie	Packaging/Opakowanie	Cod.
19	9,5	14	11	33	Zinc plated/Cynkowane	250 KIT/Zestaw	4460105

Steel, Zamak/Stal, Znal



Includes:  
 - 4406905 eccentric.  
 - 5137805 bolt.

Zawiera:  
 - 4406905 mimośród.  
 - Śruba 5137805.

T15 of Ø15 Cam  
 ExcêntricaMimośród 13

Board thickness/Grubość płyty	X	Y	Finishing/Wykończenie	Packaging/Opakowanie	Cod.
13	6.5	11	Natural zamak/Znal naturalny 	2500 Unit/Szt	8005401

Zamak/Znal

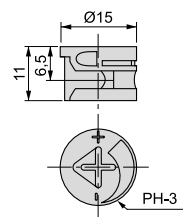



Cams reinforced with cover rim  
 Krzywki wzmocnione obrzeżem pokrywy

Board thickness/Grubość płyty	X	Y	Finishing/Wykończenie	Packaging/Opakowanie	Cod.
18	9	14	Nickel plated/Niklowane 	1250 Unit/Szt	8007007

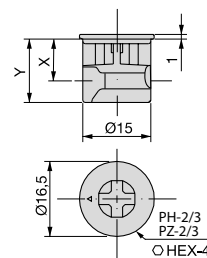
Zamak/Znal



Cams reinforced  
 ExcêntricaMimośród zbrojona 19 / 25

Board thickness/Grubość płyty	X	Y	Finishing/Wykończenie	Packaging/Opakowanie	Cod.
19	9.5	14	Natural zamak/Znal naturalny 	2500 Unit/Szt	8206901
19	9.5	14	Zinc plated/Cynkowane 	2500 Unit/Szt	8206905
25	12.5	17.5	Zinc plated/Cynkowane 	1250 Unit/Szt	8006605

Zamak/Znal

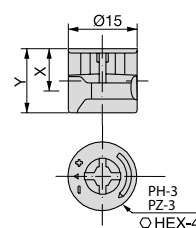



**Ribbed pins**  
**Śruba oczkowa**

A	Z	F	Finishing/Wykończenie	Packaging/Opakowanie	Cod.
23	8	M6	Zinc plated/Cynkowane	2500 Unit/Szt	5139805
23	9	Ø6	Zinc plated/Cynkowane	2500 Unit/Szt	5140005
27	8	M6	Zinc plated/Cynkowane	2500 Unit/Szt	5139905
33	8	M6	Zinc plated/Cynkowane	2500 Unit/Szt	5137705
33	11	Ø6	Zinc plated/Cynkowane	2500 Unit/Szt	5137605

Steel/Stal

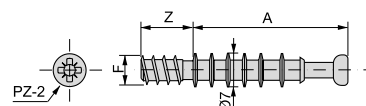

**Solid pins**  
**Solidna śruba**

A	Z	F	Finishing/Wykończenie	Packaging/Opakowanie	Cod.
33	11	Ø6	Zinc plated/Cynkowane	2500 Unit/Szt	5137805
33	8	M6	Zinc plated/Cynkowane	2500 Unit/Szt	5137905

Steel/Stal

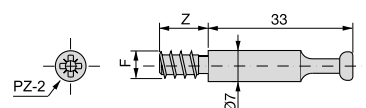

**Bolt with plastic sheath**  
**Śruba z tworzywa sztucznego**

A	Z	F	Finishing/Wykończenie	Packaging/Opakowanie	Cod.
33	11	Ø6	Zinc plated/Cynkowane	2500 Unit/Szt	5141305

Plastic, Steel/Plastik, Stal

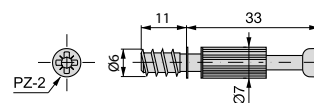

Double dowel for T15 eccentric T15 Ø15  
 Podwójny Trzpień do mimośrodków T15 o Ø15

A	Board thickness/Crubość płyty	Finishing/Wykończenie	Packaging/Opakowanie	Cod.
16	16 mm	Zinc plated/Cynkowane	500 Unit/Szt	5114505
19	19 mm	Zinc plated/Cynkowane	500 Unit/Szt	5114605

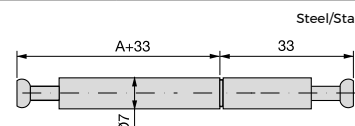
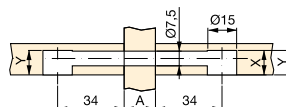

Articulated double dowel for T15 eccentric T15 Ø15  
 Podwójny Trzpień przegubowy do mimośrodków T15 o Ø15

Finishing/Wykończenie	Packaging/Opakowanie	Cod.
Zinc plated/Cynkowane	500 Unit/Szt	8044505

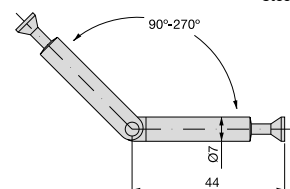
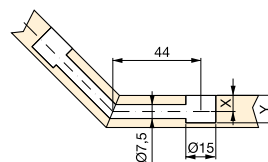

Fit Ø8 expanding bolt  
 Rozsuwana śruba Fit Ø8



A	Finishing/Wykończenie	Packaging/Opakowanie	Cod.
21,6	Zinc plated/Cynkowane	2500 Unit/Szt	5912805
31,6	Zinc plated/Cynkowane	2500 Unit/Szt	5912905

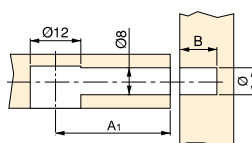

	A	A <sub>1</sub>	Ø	B
Fit Ø8	21,6	24	8	11
Fit Ø10	31,6	34	10	11

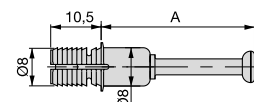

Covercaps for T15 eccentric T15 Ø15  
 Zatyczka do mimośrodków T15 o Ø15

Finishing/Wykończenie	Packaging/Opakowanie	Cod.
White plastic/Biały plastik	1250 Unit/Szt	9040715
Black plastic/Czarny plastik	1250 Unit/Szt	9040717

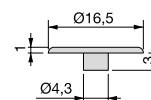

Ø25 Cam  
 Mimośród

Finishing/Wykończenie	Packaging/Opakowanie	Cod.
Natural zamak/Znal naturalny	1250 Unit/Szt	8004601

Zamak/Znal

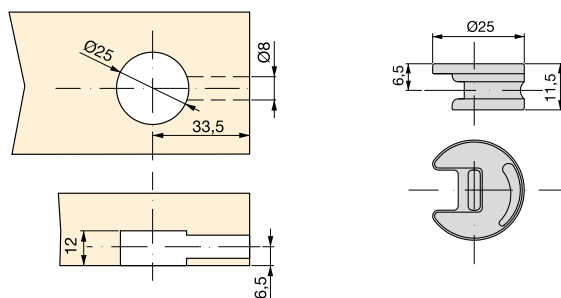



Bolt for Eccentric Ø25  
 Trzpień do mimośródów Ø25

Z	F	Finishing/Wykończenie	Packaging/Opakowanie	Cod.
9	EU M6	Zinc plated/Cynkowane	2500 Unit/Szt	5004905

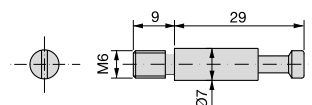
Steel/Stal



**Big Ø35 Cam**  
**Mimośród Big**

Finishing/Wykończenie	Packaging/Opakowanie	Cod.
Natural zamak/Znal naturalny 	250 Unit/Szt	8085701
Zinc plated/Cynkowane 	250 Unit/Szt	8085705

Zamak/Znal

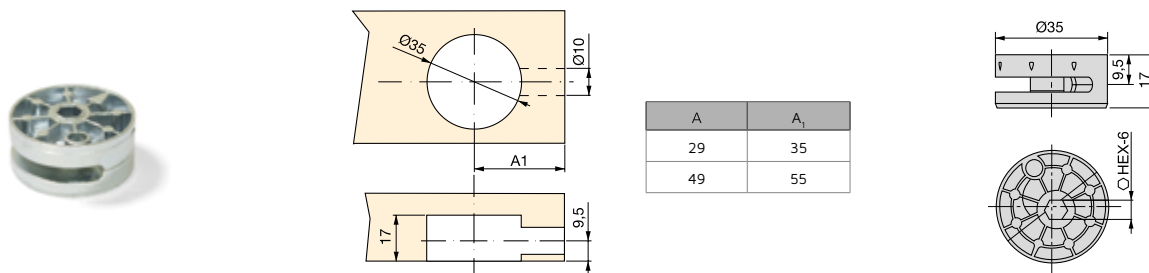

**Bolt**  
**Śruba**

A	F	Finishing/Wykończenie	Packaging/Opakowanie	Cod.
49	EU M8	Zinc plated/Cynkowane 	500 Unit/Szt	8086205

Steel/Stal



**Covercaps for Eccentric Big Ø35**  
**Zaślepka Mimośrody do mimośrodi Big Ø35**

Finishing/Wykończenie	Packaging/Opakowanie	Cod.
White plastic/Biały plastik 	500 Unit/Szt	8285715

Plastic/Plastik



**Cams and dowels kit and bolt M8**  
**Złącze mimośrodowe + śruba i nakrętka M8**

Diametre/Średnica	Finishing/Wykończenie	Packaging/Opakowanie	N° pieces/Liczba elementów	Cod.
35	White plastic/Biały plastik 	1 LOT/Partia	10 kit/10 zestawów	4020615

Plastic, Steel, Zamak/Plastik, Stal, Znal

**KITS**



- Includes:
- 8085701 eccentric.
  - 8086205 bolt.
  - 8285715 cover.
  - 8007601 nut Ø12mm and M8.

- Zawiera:
- 8085701 mimośród.
  - Śruba 8086205.
  - 8285715 pokrywa.
  - 8007601 nakrętka Ø12 mm i M8.

Spiral coupling Ø35 closed  
 Spiral złącze Ø35 zamknięte

Finishing/Wykończenie	Packaging/Opakowanie	Cod.
Zinc plated/Cynkowane	250 Unit/Szt	4461505

Zamak/Znal

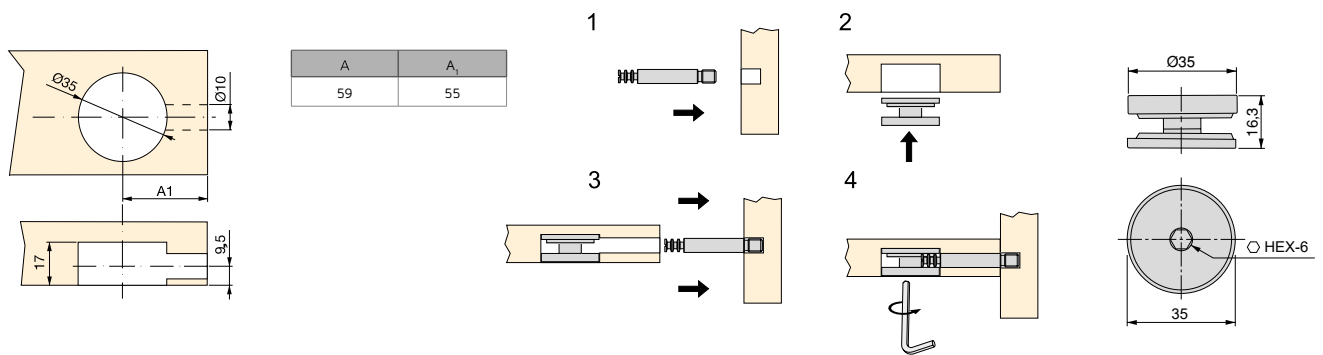

Spiral Bolt  
 Śruba Spiral

A	F	Finishing/Wykończenie	Packaging/Opakowanie	Cod.
59	M8	Zinc plated/Cynkowane	500 Unit/Szt	4006905

Steel/Stal

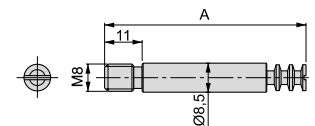

Excentric bed coupling Ø35 and bolt M5x64  
 Sprzęgło łoża mimośrodowego Ø35 i śruba M5x64

Finishing/Wykończenie	Packaging/Opakowanie	Cod.
Natural zamak/Znal naturalny	50 KIT/Zestaw	4461001

Steel, Zamak/Stal, Znal

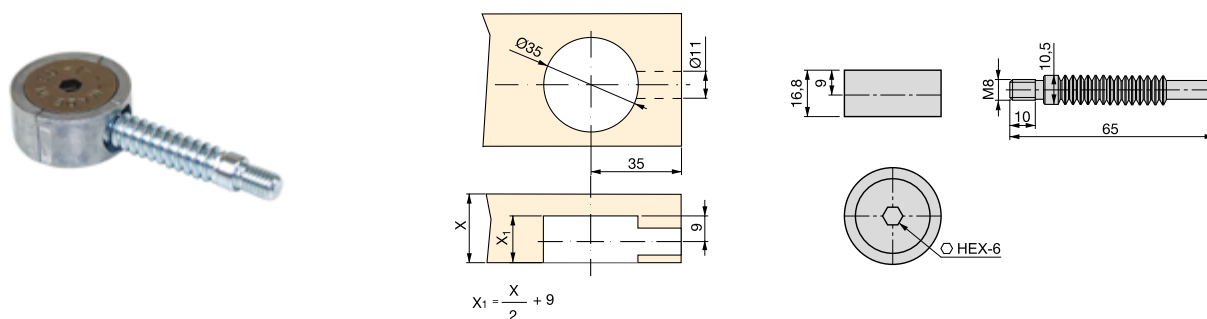

BLOCK SYSTEM FASTENERS / ZACZEP BLOCK SYSTEM

Catch Block System H12mm  
 Zaczepek System blokowania H12mm

Finishing/Wykończenie	Packaging/Opakowanie	Cod.
White plastic/Biały plastik	2500 Unit/Szt	9016215

Plastic/Plastik

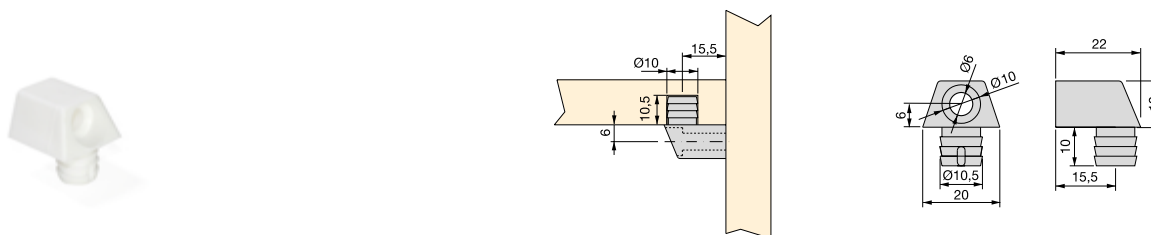

Catch Normal 720  
 Zaczepek Normal 720

Finishing/Wykończenie	Packaging/Opakowanie	Cod.
Natural steel/Naturalna stal	250 Unit/Szt	4010903

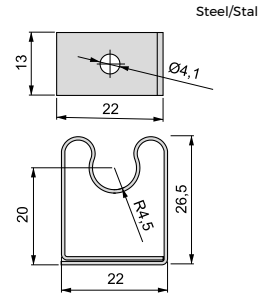

Bolt for Normal hitch 720  
 Trzpień do zaczepu klinowego Normal 720

Finishing/Wykończenie	Packaging/Opakowanie	Cod.
Zinc plated/Cynkowane	250 Unit/Szt	4011005

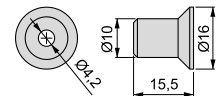
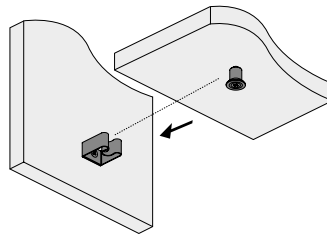

JOINT BRACES / KĄTOWNIKI ŁĄCZĄCE

Furniture brackets 70 x 22,5 mm  
 Kątownik do mebli 70 x 22,5 mm

N° pieces/Liczba elementów	Acabado/Acabamento	Packaging/Opakowanie	Cod.
50 units/50 sztuk	Zinc plated/Cynkowane	1 LOT/Partia	4021305
500 units/500 sztuk	Zinc plated/Cynkowane	500 Unit/Szt	5135805

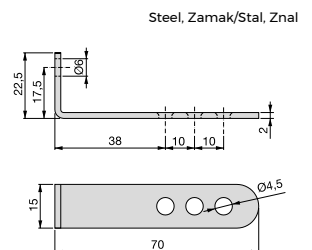

Brace 2 hole 34 x 23,5  
Kątownik z 2 otworami 34 x 23,5

Finishing/Wykończenie	Packaging/Opakowanie	Cod.
Zinc plated/Cynkowane	1000 Unit/Szt	8030205

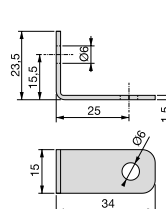

Steel/Stal

Furniture brackets 42 x 42 mm  
Kątownik do mebli 42 x 42 mm

N° pieces/Liczba elementów	Finishing/Wykończenie	Packaging/Opakowanie	Cod.
50 units/50 sztuk	Zinc plated/Cynkowane	1 LOT/Partia	4021505
1000 units/1000 sztuk	Zinc plated/Cynkowane	1000 Unit/Szt	8219805

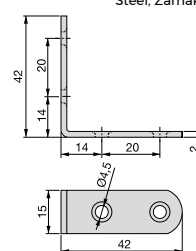

Steel, Zamak/Stal, Znal

Furniture brackets, 20.5 x 20.7 mm  
Kątownik do mebli 20,5 x 20,7 mm

N° pieces/Liczba elementów	Finishing/Wykończenie	Packaging/Opakowanie	Cod.
50 units/50 sztuk	Nickel plated/Niklowane	1 LOT/Partia	4020907
1250 units/1250 sztuk	Nickel plated/Niklowane	1250 Unit/Szt	8072507

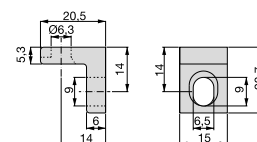

Zamak/Zamak

T braces  
Kątownik T

Finishing/Wykończenie	Packaging/Opakowanie	Cod.
Nickel plated/Niklowane	500 Unit/Szt	8030907

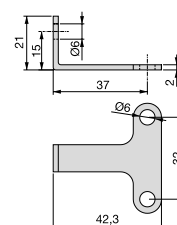

Steel/Stal



**Glass fastener**  
**Element łączący do szkła**

Finishing/Wykończenie	Packaging/Opakowanie	Cod.
Not defined/Nieokreślone	1000 Unit/Szt	8092420

Plastic/Plastik

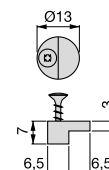
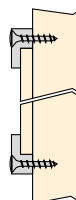

**Plate for fixing**  
**Płytką z 4 otworami do mocowania**

Finishing/Wykończenie	Packaging/Opakowanie	Cod.
Zinc plated/Cynkowane	1000 Unit/Szt	8217405

Steel/Stal

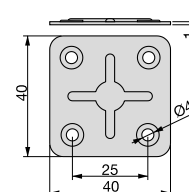



**Square staples for fixing**  
**Zszywka kwadratowa do mocowania**

Finishing/Wykończenie	Packaging/Opakowanie	Cod.
Zinc plated/Cynkowane	5000 Unit/Szt	8200505

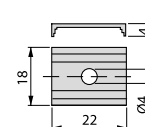
Steel/Stal



Pre-assembled angle fastener  
 Kątowny element mocujący



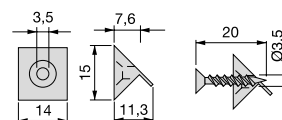

Finishing/Wykończenie		Packaging/Opakowanie	Cod.
White plastic/Biały plastik		1000 Unit/Szt	9169715
Black plastic/Czarny plastik		1000 Unit/Szt	9169717

Plastic, Steel/Plastik, Stal



DEUVELS OS HOUT / KOŁKI DREWNIANE

Dowels os wood, Press-fit system  
 System łączenia Kołki drewniane

Diametre/Średnica	X	Finishing/Wykończenie		Packaging/Opakowanie	Cod.
6	30	Beech wood/Drewno bukowe		34000 Unit/Szt	9095678
8	30	Beech wood/Drewno bukowe		18800 Unit/Szt	9091978
8	35	Beech wood/Drewno bukowe		16300 Unit/Szt	9031878
8	40	Beech wood/Drewno bukowe		14400 Unit/Szt	9091778
10	40	Beech wood/Drewno bukowe		9000 Unit/Szt	9094878

Wood/Drewno

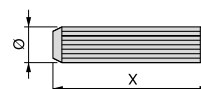

## Joining systems for shelves Systemy łączenia półek

We have many solutions for joining shelves, ideal for mounting shelves in wardrobes, bookcases or shelving.

Mamy wiele rozwiązań do łączenia półek, idealnych do montażu półek w szafach, regałach lub półkach.

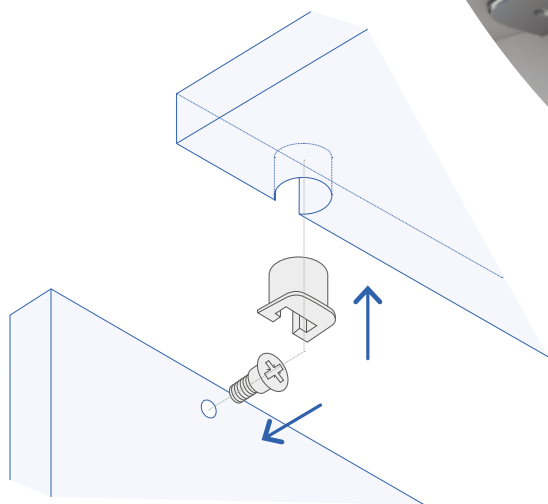

The Simply bracket is suitable for Ø3 or Ø5 mm racks, depending on the model.

Wspornik Simply nadaje się do stojaków Ø3 lub Ø5 mm, w zależności od modelu.

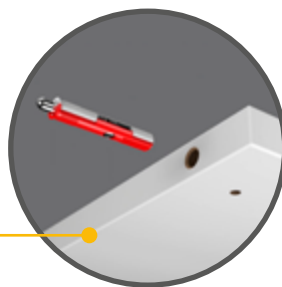

Catch  
Zaczep

Simply



Shelf supports  
Zaczep

UniBlock

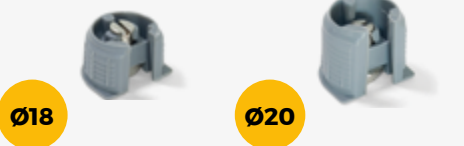

Fix

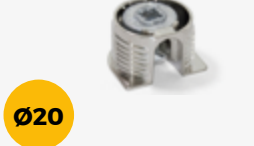

Luna



The oxide black is made in an electrolytic process which guarantees aesthetics and durability.

Czarna powłoka tlenkowa wykonana jest w procesie elektrolitycznym, co gwarantuje estetykę i trwałość.

Insert fastener  
Zaczep klinowy

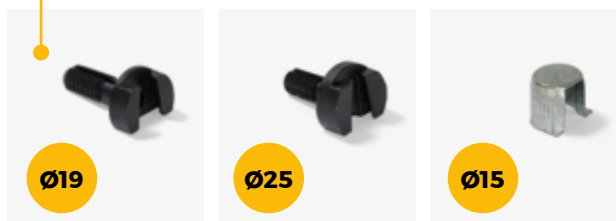

Simply Hidden Wooden Shelf Support  
 Łatwo chowany drewniany wspornik szafek



Diametre/Srednica	X	Y	Finishing/Wykończenie	Packaging/Opakowanie	Cod.
3	6	1,6	Not defined/Nieokreślone <input type="checkbox"/>	240 Unit/Szt	4014520
5	7	2,5	Not defined/Nieokreślone <input type="checkbox"/>	240 Unit/Szt	4014620

Plastic, Steel/Plastik, Stal

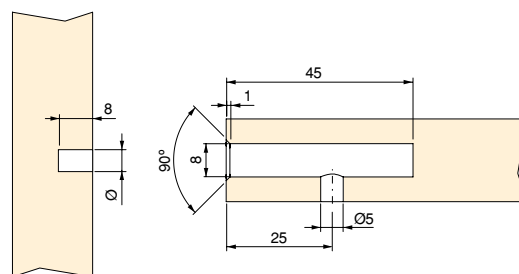
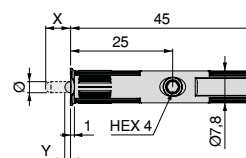

UNIBLOCK SHELF SUPPORTS / ZACZEP UNIBLOCK

Inserts Ø18 for UniBlock coupling  
 Wstawka Ø18 do zaczepu klinowego UniBlock

Board thickness/Grubość płyty	Y	Finishing/Wykończenie	Packaging/Opakowanie	Cod.
16-19	13	Grey plastic/Szary plastik <input type="checkbox"/>	2500 Unit/Szt	8175021
22-30	17.5	Grey plastic/Szary plastik <input type="checkbox"/>	2500 Unit/Szt	8175421

Plastic, Zamak/Plastik, Znal

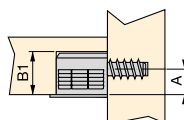
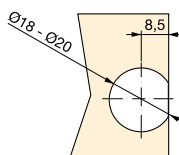

B	B <sub>1</sub>
13	13,5
14	15
16	18
17	18
21	22

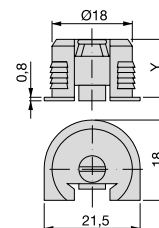

Inserts Ø20 for UniBlock coupling  
 Wstawka Ø20 do zaczepu klinowego UniBlock

Board thickness/Grubość płyty	Y	Finishing/Wykończenie	Packaging/Opakowanie	Cod.
16-19	13	Grey plastic/Szary plastik	2500 Unit/Szt	8175121
22-30	17.5	Grey plastic/Szary plastik	2500 Unit/Szt	8175621

Plastic, Zamak/Plastik, Znal

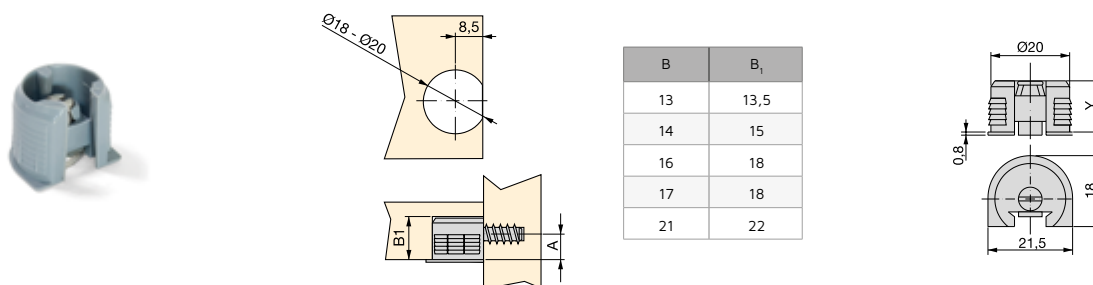

Supports for UniBlock coupling  
 Wspornik do zaczepu klinowego Uniblock

A	B	Board thickness/Grubość płyty	Finishing/Wykończenie	Packaging/Opakowanie	Cod.
8	13	16	Nickel plated/Niklowane	1250 Unit/Szt	8175207
9.5	14	19	Nickel plated/Niklowane	1250 Unit/Szt	8175907
12.5	17	25	Nickel plated/Niklowane	1250 Unit/Szt	8176007
15	21	30	Nickel plated/Niklowane	1250 Unit/Szt	8176807
9.5	14	19	Black oxide/Czarny oksydowany	1250 Unit/Szt	8175953

Zamak/Znal



Supports for Fix coupling Ø20

Wspornik do zaczepu klinowego Fix Ø20

Board thickness/Grubość płyty	X	Y	Finishing/Wykończenie	Packaging/Opakowanie	Cod.
16	8	12.5	Nickel plated/Niklowane	1000 Unit/Szt	8470907
19	9.5	14.5	Nickel plated/Niklowane	1000 Unit/Szt	8070907

Zamak/Znal

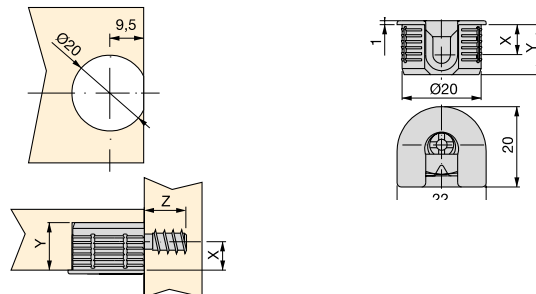

Bolt  
Śruba

Z	F	Finishing/Wykończenie	Packaging/Opakowanie	Cod.
8	Ø6	Zinc plated/Cynkowane	1000 Unit/Szt	8905205
11	Ø6	Zinc plated/Cynkowane	1000 Unit/Szt	8905305

Steel/Stal

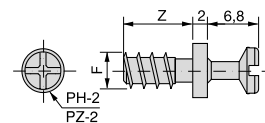

Bolt for Fix coupling Ø20

Śruba z łbem walcowym do zaczepu klinowego Fix Ø20

Z	F	Finishing/Wykończenie	Packaging/Opakowanie	Cod.
11	Ø6	Natural zamak/Znal naturalny	1000 Unit/Szt	8083901
8	Ø6	Natural zamak/Znal naturalny	1000 Unit/Szt	8084001

Zamak/Znal

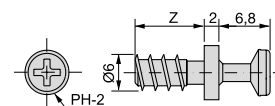

**Ø15 inserts Miniluna**  
**Wstawka Miniluna Ø15**

Board thickness/Grubość płyty	X	Y	Finishing/Wykończenie	Packaging/Opakowanie	Cod.
13	6,5	10,5	Grey plastic/Szary plastik	2500 Unit/Szt	5042321

Plastic/Plastik

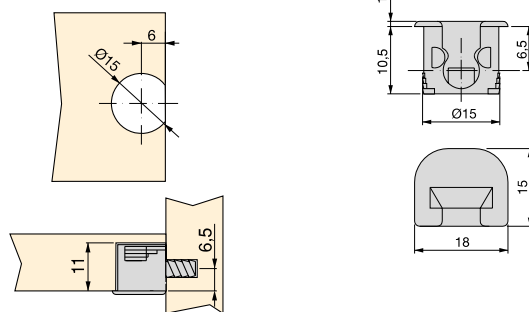

**Ø20 inserts Luna**  
**Wstawka Luna Ø20**

Board thickness/Grubość płyty	X	Y	Finishing/Wykończenie	Packaging/Opakowanie	Cod.
16	8	13	White plastic/Biały plastik	2500 Unit/Szt	9028215
16	8	13	Brown plastic/Brazowy plastik	2500 Unit/Szt	9028216

Steel/Stal

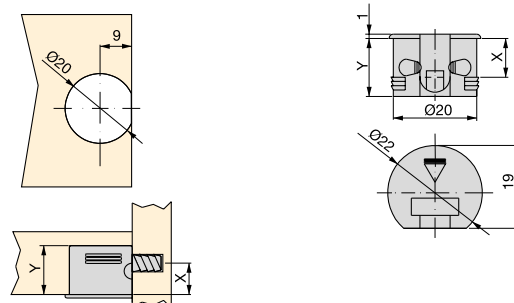

**Bolt for Luna coupling**  
**Śruba do zaczepu klinowego Luna**

Z	F	Finishing/Wykończenie	Packaging/Opakowanie	Cod.
11	Ø4.2	Zinc plated/Cynkowane	2500 Unit/Szt	8043005
9	Ø6	Zinc plated/Cynkowane	2500 Unit/Szt	8032605

Steel/Stal

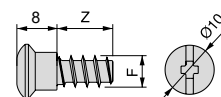

Supports for wedge coupling Ø19  
 Engate do zaczepu klinowego Ø19

Finishing/Wykończenie	Packaging/Opakowanie	Cod.
Black plastic/Czarny plastik 	2500 Unit/Szt	9026817

Plastic/Plastik

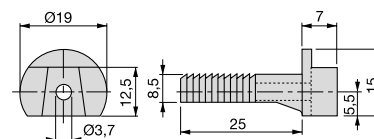
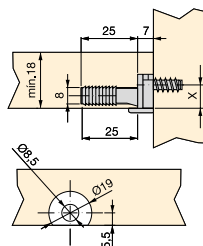

Supports for wedge coupling Ø19  
 Wspornik do zaczepu klinowego Ø19

Board thickness/Grubość płyty	X	Finishing/Wykończenie	Packaging/Opakowanie	Cod.
18	9	Nickel plated/Niklowane 	2500 Unit/Szt	8026107
20	10	Nickel plated/Niklowane 	2500 Unit/Szt	8025807

Zamak/Znal

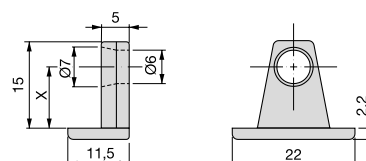

Expanding tip for wedge coupling Ø19  
 Wskazówka dotycząca rozszerzenia do zaczepu klinowego Ø19

Finishing/Wykończenie	Packaging/Opakowanie	Cod.
Zinc plated/Cynkowane 	10000 Unit/Szt	8027705

Steel/Stal

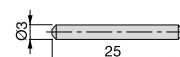

Expanding tip for wedge coupling Ø19  
 Wskazówka dotycząca rozszerzenia do zaczepu klinowego Ø19

Finishing/Wykończenie	Packaging/Opakowanie	Cod.
Not defined/Nieokreślone 	10000 Unit/Szt	9027620

Plastic/Plastik

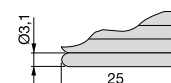



Supports for wedge coupling Ø25  
 Wspornik do zaczepu klinowego Ø25

Finishing/Wykończenie	Packaging/Opakowanie	Cod.
Black plastic/Czarny plastik	2000 Unit/Szt	9024117

Plastic/Plastik

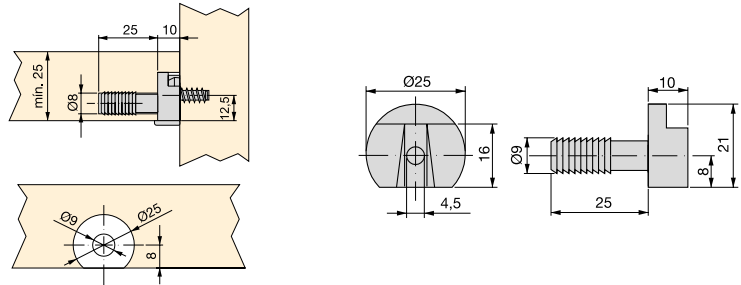

Supports for wedge coupling Ø25  
 Wspornik do zaczepu klinowego Ø25

Board thickness/Grubość płyty	x	Finishing/Wykończenie	Packaging/Opakowanie	Cod.
25	12.5	Nickel plated/Niklowane	2000 Unit/Szt	8024307

Zamak/Znal

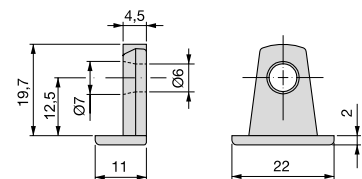

Insert for wedge coupling Ø15  
 Wstawka do zaczepu klinowego Ø15

Finishing/Wykończenie	Packaging/Opakowanie	Cod.
Natural zamak/Znal naturalny	2500 Unit/Szt	8046401

Zamak/Znal

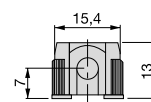
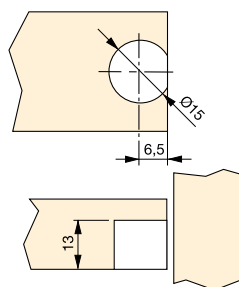

Supports for wedge coupling Ø15  
 Wspornik do zaczepu klinowego Ø15

Finishing/Wykończenie	Packaging/Opakowanie	Cod.
Nickel plated/Niklowane	2500 Unit/Szt	8146407

Zamak/Znal

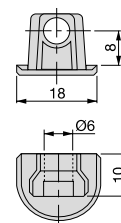

## Shelf brackets Wsporniki do półek

Supports for wooden or glass shelves.  
They are installed by means of a bolt that is embedded in the side of the furniture.

Wsporniki do drewnianych lub szklanych półek.  
Montuje się je za pomocą śruby osadzonej w boku mebla.

Ø3

Ø5

Choose nickel-plated or oxide black finish.

Do wyboru wykończenie nikielowane lub oksydowane na czarno.

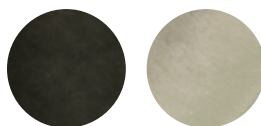

## Beak support for wooden shelf

## Wspornik Beak do półki drewnianej

Diametre/Średnica	Finishing/Wykończenie	Packaging/Opakowanie	Cod.
3	Nickel plated/Niklowane	1000 Unit/Szt	4015207
5	Nickel plated/Niklowane	1000 Unit/Szt	4015507

Zamak/Znal

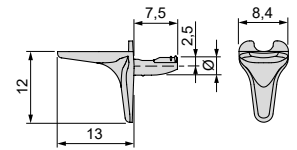
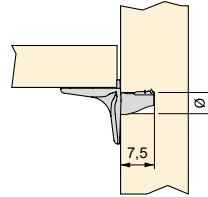

## 21A support for wooden shelf

## Wspornik 21A do półki drewnianej

Ø5

Finishing/Wykończenie	Packaging/Opakowanie	Cod.
Nickel plated/Niklowane	1000 Unit/Szt	8114207

Zamak/Znal

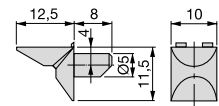
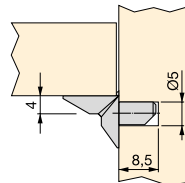

## Shelf support for wood

## Podpora z trzpieniem z drewna

Ø5

Finishing/Wykończenie	Packaging/Opakowanie	Cod.
Nickel plated/Niklowane	100 Unit/Szt	4013607

Zamak/Znal

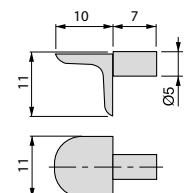
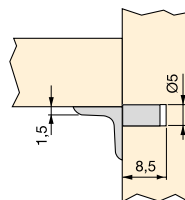

## Shelf support for wood with 1 bolt

Wspornik do półek drewnianych z 1 kołkiem

Ø5

Finishing/Wykończenie	Packaging/Opakowanie	Cod.
Nickel plated/Niklowane 	1000 Unit/Szt	4030407

Zamak/Znal

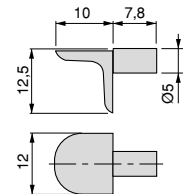
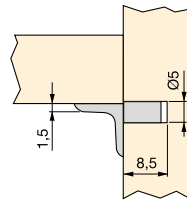

## Shelf support for wood with 1 knurled bolt

Wspornik do półek drewnianych z 1 kołkiem drewnianym

Finishing/Wykończenie	Packaging/Opakowanie	Cod.
Nickel plated/Niklowane 	1000 Unit/Szt	4030307

Zamak/Znal

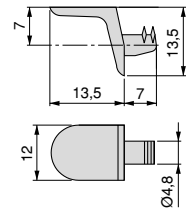
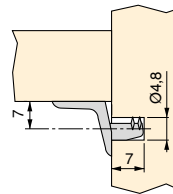

## Shelf support for wood with 2 bolts

Wspornik do półek drewnianych z 2 kołkami

Finishing/Wykończenie	Packaging/Opakowanie	Cod.
Nickel plated/Niklowane 	1000 Unit/Szt	4030207

Zamak/Znal

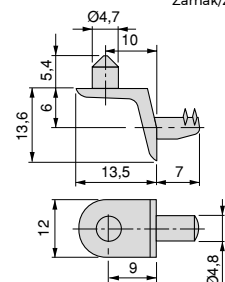
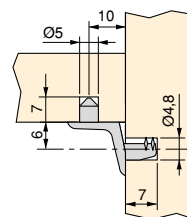

## Beak support for wooden shelf with bolt

Wspornik Beak do półki drewnianej z kołkami

Diametre/Średnica	Finishing/Wykończenie	Packaging/Opakowanie	Cod.
3	Nickel plated/Niklowane	1000 Unit/Szt	4015107
5	Nickel plated/Niklowane	1000 Unit/Szt	4015407
5	Black zinc plated/Cynkowana czerni	1000 Unit/Szt	4015409

Zamak/Znal

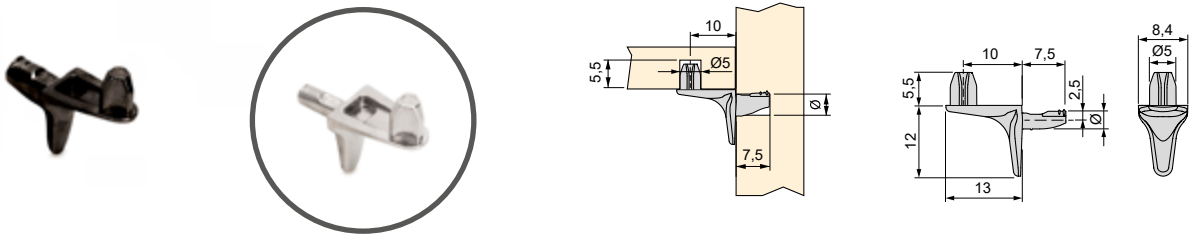

## Shelf support for wood

Podpora półek na 2 trzpienie z drewna

Ø5

Finishing/Wykończenie	Packaging/Opakowanie	Cod.
Nickel plated/Niklowane	1000 Unit/Szt	8184107

Zamak/Znal

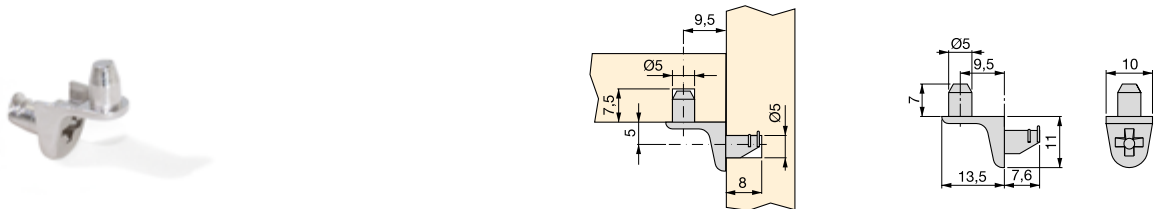

## Shelf support for wood

Podpora ze śrubą i trzpieniem z drewna

Ø5

Finishing/Wykończenie	Packaging/Opakowanie	Cod.
Nickel plated/Niklowane	1000 Unit/Szt	8114107

Steel, Zamak/Stal, Znal

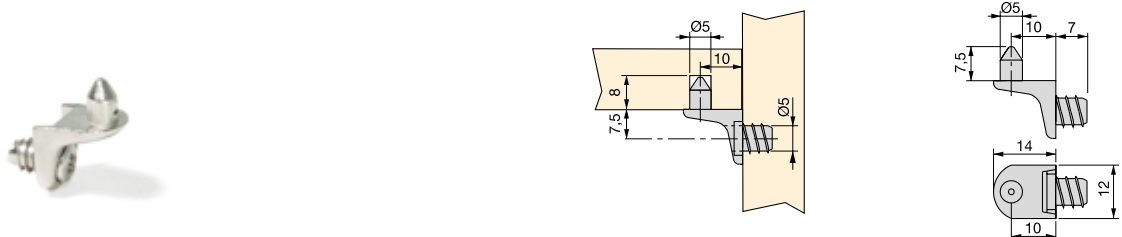

Shelf support for wood  
Wspornik przykręcany z drewna

Finishing/Wykończenie	Packaging/Opakowanie	Cod.
Nickel plated/Niklowane 	1000 Unit/Szt	8014107

Zamak/Znal

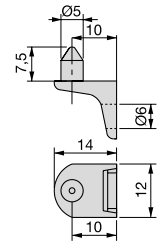
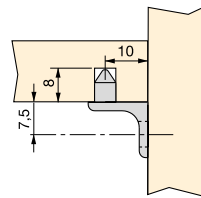

Shelf support for wood  
Wspornik półki Ø10 z drewna



Ø5

Finishing/Wykończenie	Packaging/Opakowanie	Cod.
Nickel plated/Niklowane 	2000 Unit/Szt	8045207

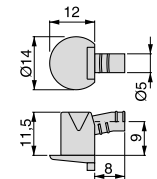
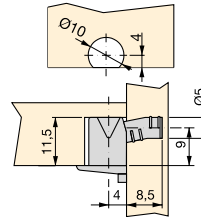
Zamak/Znal



Frontal shelf support  
Wspornik przedniej półki

X	Finishing/Wykończenie	Packaging/Opakowanie	Cod.
16	Not defined/Nieokreślone 	5000 Unit/Szt	8038820
18	Not defined/Nieokreślone 	5000 Unit/Szt	8038720

Plastic/Plastik

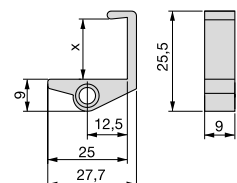
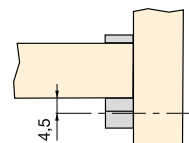

## Plug support for shelf

## Podpora półki

Ø3

Ø5

A	B	C	Diametre/Srednica	Finishing/Wykończenie	Packaging/Opakowanie	Cod.
15	7,5	1,7	3	Nickel plated/Niklowane 	5000 Unit/Szt	8049707
19	8	3	5	Nickel plated/Niklowane 	1000 Unit/Szt	5062107

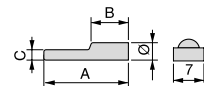
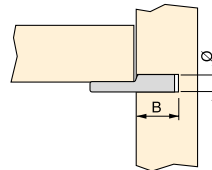

Steel/Stal



## Shelf support for wood

## Wspornik półki z drewna

Ø5

Finishing/Wykończenie	Packaging/Opakowanie	Cod.
Zinc plated/Cynkowane 	5000 Unit/Szt	5062305
Nickel plated/Niklowane 	100 Unit/Szt	4013807
Nickel plated/Niklowane 	5000 Unit/Szt	5062307

Steel/Stal

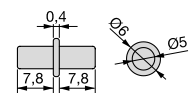
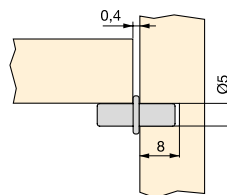

## Shelf support for wood

## Wspornik z drewna

Ø3

Finishing/Wykończenie	Packaging/Opakowanie	Cod.
Nickel plated/Niklowane 	10000 Unit/Szt	5009707

Steel/Stal

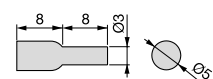
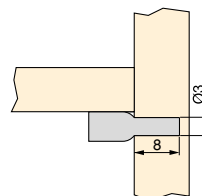









## Shelf support Sekure

## Wspornik Sekure ze sworzniem

Ø3

Ø5

Diametre/Średnica	Finishing/Wykończenie	Packaging/Opakowanie	Cod.
3	White plastic/Biały plastik 	250 Unit/Szt	4008715
5	White plastic/Biały plastik 	250 Unit/Szt	4008815
3	Grey plastic/Szary plastik 	250 Unit/Szt	4008721
5	Grey plastic/Szary plastik 	250 Unit/Szt	4008821
3	Anthracite grey plastic/Szaro-antracytowy plastik 	250 Unit/Szt	4008723
5	Anthracite grey plastic/Szaro-antracytowy plastik 	250 Unit/Szt	4008823

Plastic, Steel/Plastik, Stal

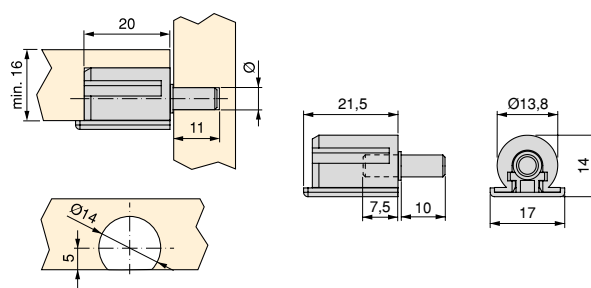
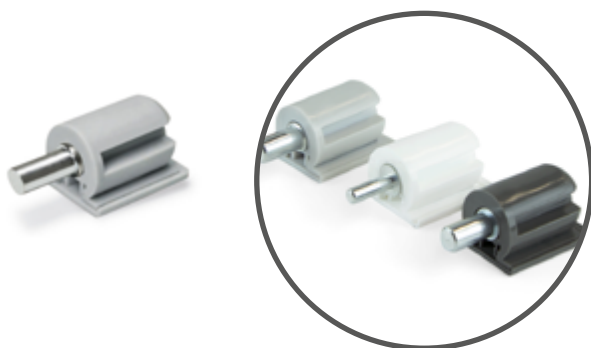





## Shelf support

## Wspornik z trzpieniem metalicznym

Ø3



Ø5

Diametre/Średnica	Finishing/Wykończenie	Packaging/Opakowanie	Cod.
5	White plastic/Biały plastik 	1000 Unit/Szt	5081015
3	Not defined/Nieokreślone 	1000 Unit/Szt	5020020
5	Not defined/Nieokreślone 	1000 Unit/Szt	5081020
5	Not defined/Nieokreślone 	100 Unit/Szt	5081120

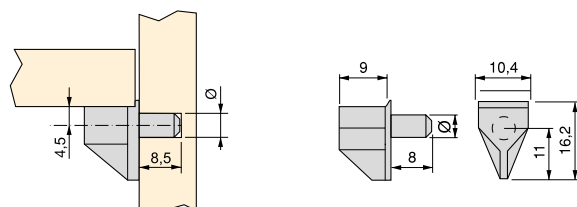
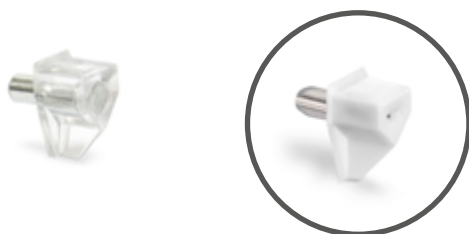
Plastic, Steel/Plastik, Stal



Beak support for glass shelf  
Podpora Beak do półki szklanej

Diametre/Średnica	Finishing/Wykończenie	Packaging/Opakowanie	Cod.
3	Nickel plated/Niklowane 	1000 Unit/Szt	4015307
5	Nickel plated/Niklowane 	1000 Unit/Szt	4015607
5	Black zinc plated/Cynkowana czerń 	1000 Unit/Szt	4015609

Zamak/Znal

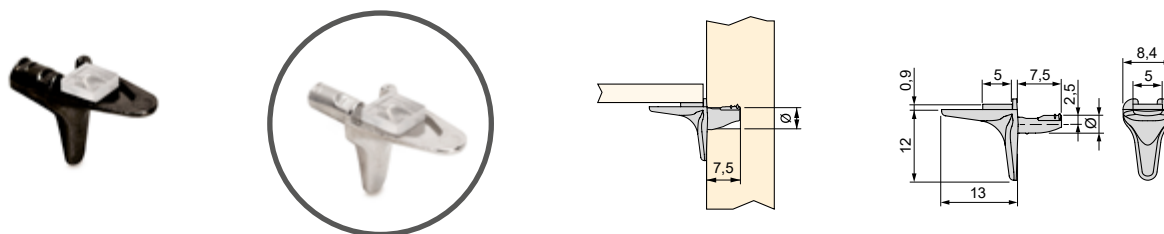

21B support for glass shelf  
Wspornik 21B do półki szklanej

Ø5

Finishing/Wykończenie	Packaging/Opakowanie	Cod.
Nickel plated/Niklowane 	1000 Unit/Szt	8114007

Plastic, Zamak/Plastik, Znal

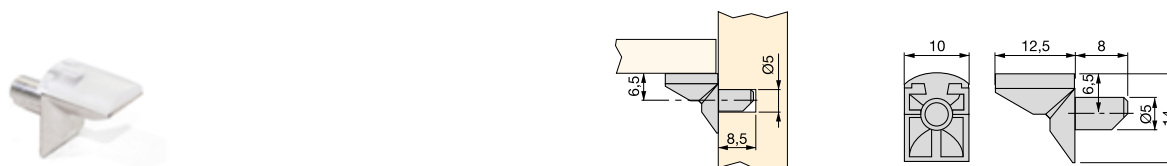

Shelf fixing system  
System mocowania półek

Ø5

Diametre/Średnica	Finishing/Wykończenie	Packaging/Opakowanie	Cod.
5	Not defined/Nieokreślone 	5000 Unit/Szt	9013620

Plastic/Plastik



## Shelf support for glass

## Wspornik ze szkła

Ø5

Finishing/Wykończenie	Packaging/Opakowanie	Cod.
Nickel plated/Niklowane 	1000 Unit/Szt	8014007

Plastic, Zamak/Plastik, Znal

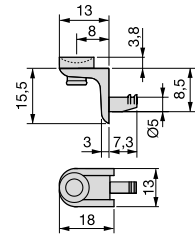
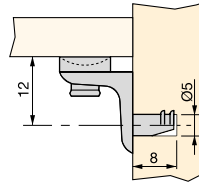

## Shelf support for glass

## Wspornik półki ze szkła

Ø5

Finishing/Wykończenie	Packaging/Opakowanie	Cod.
Nickel plated/Niklowane 	1000 Unit/Szt	8013807

Plastic, Zamak/Plastik, Znal

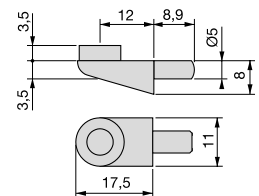
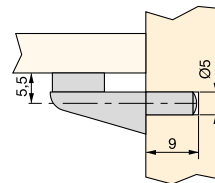

## Shelf support for glass

## Wspornik ze szkła

Ø3

Ø5

Diametre/Średnica	Finishing/Wykończenie	Packaging/Opakowanie	Cod.
5	Not defined/Nieokreślone 	1000 Unit/Szt	8055620

Plastic, Steel/Plastik, Stal

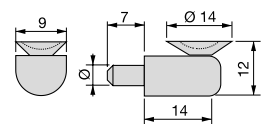
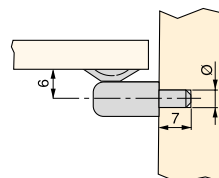

**San Remo glass support for glass shelf**  
**Wspornik San Remo do półki szklanej**

Ø5

Finishing/Wykończenie	Packaging/Opakowanie	Cod.
Nickel plated/Niklowane	1000 Unit/Szt	8194107

Plastic, Zamak/Plastik, Znal

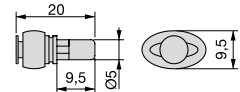
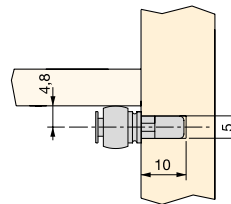

**Shelf support for glass**  
**Wspornik półki ze szkła**

Ø3

Ø5

Diametre/Średnica	Finishing/Wykończenie	Packaging/Opakowanie	Cod.
3	Nickel plated/Niklowane	1000 Unit/Szt	8013907
5	Nickel plated/Niklowane	1000 Unit/Szt	8039507

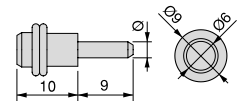
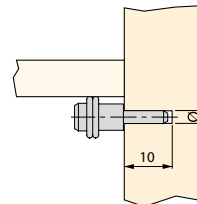
Plastic, Steel/Plastik, Stal



**Shelf support for glass**  
**Wspornik ze szkła**

Finishing/Wykończenie	Packaging/Opakowanie	Cod.
Nickel plated/Niklowane	1000 Unit/Szt	8045007

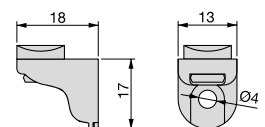
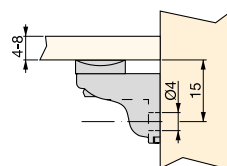
Plastic, Zamak/Plastik, Znal



**Shelf support for glass**  
**Wspornik ze szkła**

Finishing/Wykończenie	Packaging/Opakowanie	Cod.
Nickel plated/Niklowane 	1000 Unit/Szt	5062907

Plastic, Steel, Zamak/Plastik, Stal, Znal

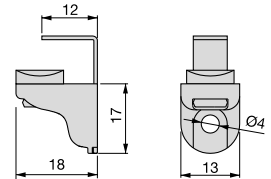
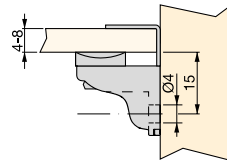
**Shelf support for glass**  
**Wspornik ze szkła**

Diametre/Srednica	X	F	Finishing/Wykończenie	Packaging/Opakowanie	Cod.
<div style="display: flex; gap: 10px;"> <div style="border: 1px solid black; padding: 2px 5px;">Ø3</div> <div style="border: 1px solid black; padding: 2px 5px;">Ø5</div> </div>	10	Ø6.3	Nickel plated/Niklowane 	1000 Unit/Szt	8071207

Plastic, Steel/Plastik, Stal

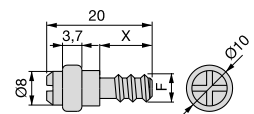
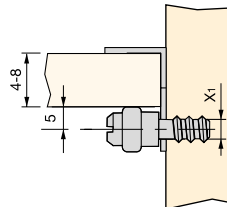
**Bracket for glass shelf**  
**Wspornik blokady do półki szklanej**

Finishing/Wykończenie	Packaging/Opakowanie	Cod.
Nickel plated/Niklowane 	1000 Unit/Szt	8071507

Steel/Stal

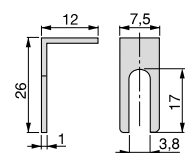

## Evo bracket for glass shelf for bolt mounting

## Uchwyt Evo do półki szklanej do montażu śrubowego

Ø3

Ø5

Diametre/Średnica	Finishing/Wykończenie	Packaging/Opakowanie	Cod.
3	Nickel plated/Niklowane	1000 Unit/Szt	4010007
5	Nickel plated/Niklowane	1000 Unit/Szt	4007907
5	Black oxide/Czarny oksydowany	1000 Unit/Szt	4007953

Plastic, Zamak/Plastik, Znal

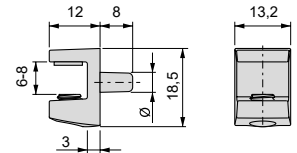
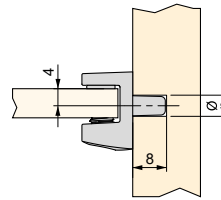

## Evo support for glass shelf for screw mounting

## Evo wspornik do półki szklanej do montażu śrubowego

Finishing/Wykończenie	Packaging/Opakowanie	Cod.
Nickel plated/Niklowane	1000 Unit/Szt	4008007

Plastic, Zamak/Plastik, Znal

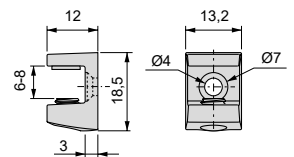
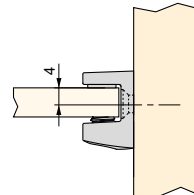

## Portofino support for glass shelf

## Podpora Portofino do półki szklanej

Ø5

Finishing/Wykończenie	Packaging/Opakowanie	Cod.
Nickel plated/Niklowane	500 Unit/Szt	8194007
Black oxide/Czarny oksydowany	500 Unit/Szt	8194053

Plastic, Zamak/Plastik, Znal

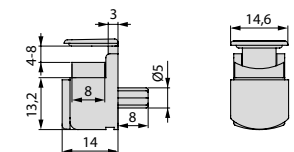
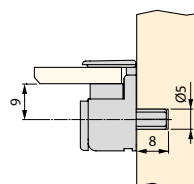

**Shelf support for glass**  
**Wspornik półki ze szkła**



Ø5

Finishing/Wykończenie	Packaging/Opakowanie	Cod.
Nickel plated/Niklowane 	1000 Unit/Szt	8621707

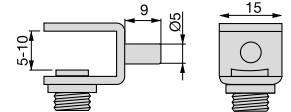
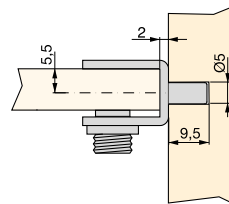
Plastic, Steel/Plastik, Stal

**Shelf support for glass**  
**Wspornik ze szkła**

Ø5

X	Y	Z	Finishing/Wykończenie	Packaging/Opakowanie	Cod.
4 - 6	4,3	8,7	Nickel plated/Niklowane 	1000 Unit/Szt	8621507
6 - 8	5,3	10,7	Nickel plated/Niklowane 	1000 Unit/Szt	8621607

Plastic, Zamak/Plastik, Znal

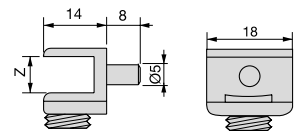
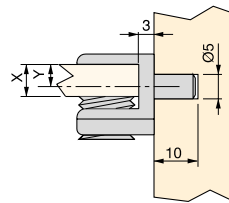
**Shelf support for glass**  
**Wspornik półki ze szkła**

Finishing/Wykończenie	Packaging/Opakowanie	Cod.
Nickel plated/Niklowane 	1000 Unit/Szt	8608407

Plastic, Steel/Plastik, Stal

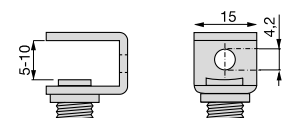
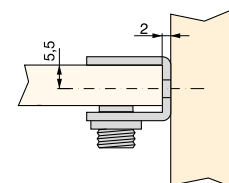

**Shelf support for glass**  
**Wspornik ze szkła**

Finishing/Wykończenie	Packaging/Opakowanie	Cod.
Nickel plated/Niklowane 	1000 Unit/Szt	8608507

Plastic, Zamak/Plastik, Znal

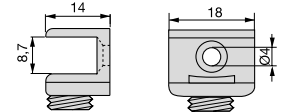
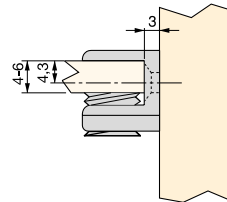
**Bumper for glass**  
**Przyssawka do półki ze szkła**

Ø5

Finishing/Wykończenie	Packaging/Opakowanie	Cod.
Not defined/Nieokreślone 	3000 Unit/Szt	8217320

Plastic/Plastik

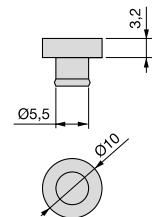
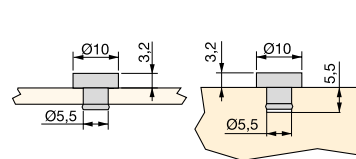
**Shelf support for glass**  
**Wspornik półki ze szkła**

Ø5

Finishing/Wykończenie	Packaging/Opakowanie	Cod.
Not defined/Nieokreślone 	2000 Unit/Szt	8154020

Plastic/Plastik

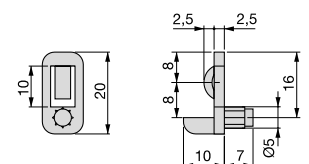
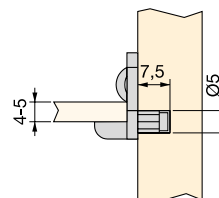



## Wall shelf supports Wsporniki do półek ściennych

Folding brackets for wall shelves, available in sizes 190, 290, 390mm with a maximum load capacity of 40, 50 or 60kg for each shelf with two brackets.

Składane wsporniki do montażu półek na ścianie, dostępne w rozmiarach 190, 290, 390 mm o maksymalnym udźwigu 40, 50 lub 60 kg na półkę z dwoma wspornikami.



KITS



The Mirage bracket allows concealed mounting inside the shelf. Maximum weight for 2 brackets including table top: 13.8 kg for 900 x 250 mm shelves.

Wspornik Mirage umożliwia ukryty montaż wewnątrz półki. Maksymalna waga dla 2 wsporników wraz z blatem: 13,8 kg dla półek 900 x 250 mm.

KITS

Folding shelf supports  
 Składane podpórki do półek

H	Longitude/Długość	Load/Ladunek	Finishing/Wykończenie	Packaging/Opakowanie	Cod.
109	203	40 kg	White painted/Malowane na biało	1 Pair/Kpl.	7018912
162	303	50 kg	White painted/Malowane na biało	1 Pair/Kpl.	7019012
176	403	60 kg	White painted/Malowane na biało	1 Pair/Kpl.	7019112

Steel/Stal

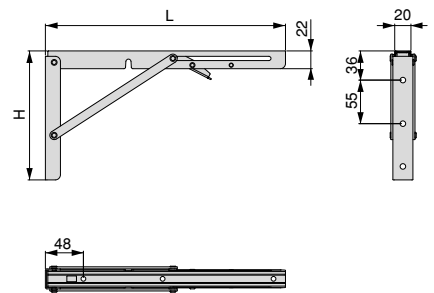

Mirage hidden shelf support for wood  
 Ukryty wspornik do półek drewnianych Mirage

Finishing/Wykończenie	Packaging/Opakowanie	Cod.
Zinc plated/Cynkowane	20 Pair/Kpl.	4015005

Steel/Stal

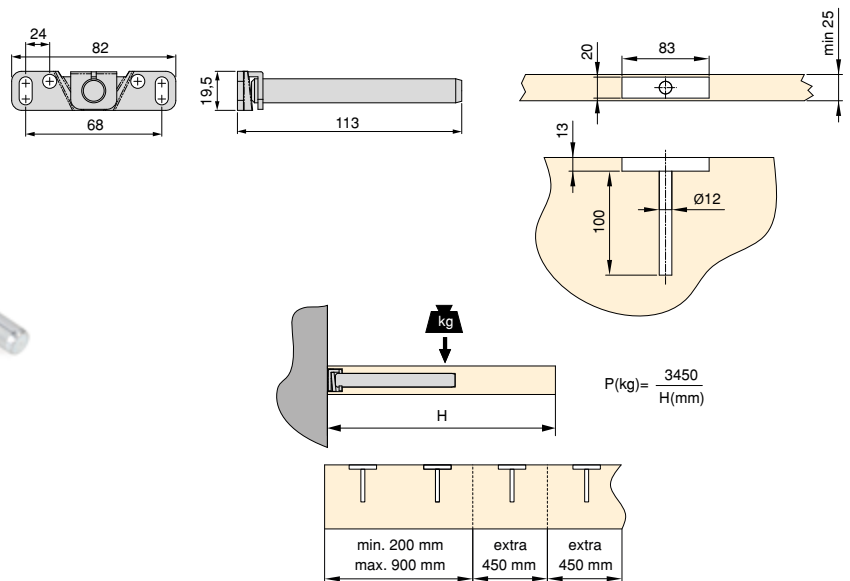

## Wall shelf supports Wsporniki do półek ściennych

Brackets for holding shelves that are fixed to the wall to create shelves.

Wsporniki do mocowania półek, które są przymocowane do ściany w celu utworzenia półek.

They comply with the UNE EN-14749:2006 standard (container furniture for domestic and kitchen use).

Są zgodne z normą UNE EN-14749:2006 (meble kontenerowe do użytku domowego i kuchennego).

They include screws and mounting plugs.

Zawierają śruby i kołki montażowe.



Squad 2 Shelf support for Wood/Glass  
 Wspornik półek drewnianych/szklanych Squad 2

Finishing/Wykończenie	Packaging/Opakowanie	Cod.
Silver painted/Malowane aluminium 	20 Pair/Kpl.	4009125

Plastic, Zamak/Plastik, Znal

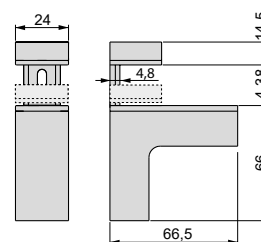
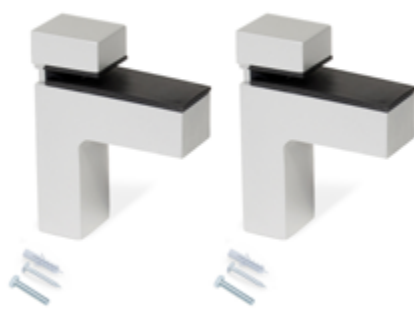



Pelicano shelf support for Wood/Glass  
 Wspornik półek drewnianych/szklanych Pelicano

Finishing/Wykończenie	Packaging/Opakowanie	Cod.
Silver painted/Malowane aluminium 	20 Pair/Kpl.	4009025

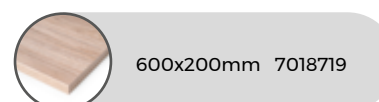
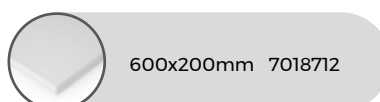
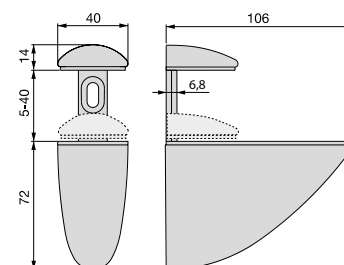
Plastic, Zamak/Plastik, Znal



**Halcon Shelf support for Wood/Glass**  
**Wspornik półek drewnianych/szklanych Halcón**

Finishing/Wykończenie	Packaging/Opakowanie	Cod.
Matt nickel painted/Malowany matowy nikiel 	20 Pair/Kpl.	4009224
Silver painted/Malowane aluminium 	20 Pair/Kpl.	4009225

Plastic, Zamak/Plastik, Znal

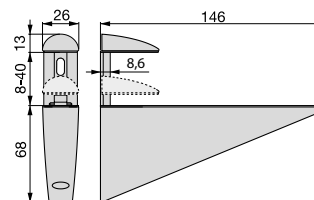
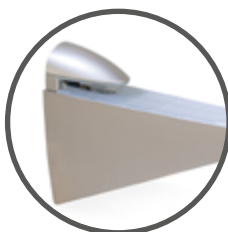

**Zipp 2 Shelf support for Wood/Glass**  
**Wspornik półek drewnianych/szklanych Zipp 2**

Finishing/Wykończenie	Packaging/Opakowanie	Cod.
Silver painted/Malowane aluminium 	20 Pair/Kpl.	4009625

Plastic, Zamak/Plastik, Znal

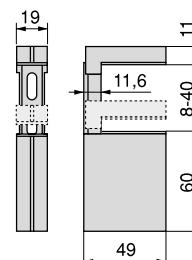

**Zipp 3 Shelf support for Wood/Glass**  
**Wspornik półek drewnianych/szklanych Zipp 3**

Finishing/Wykończenie	Packaging/Opakowanie	Cod.
Silver painted/Malowane aluminium 	20 Pair/Kpl.	4009725

Plastic, Zamak/Plastik, Znal

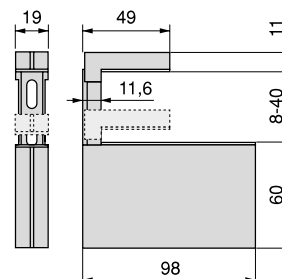

600x200mm 7018712



600x200mm 7018719

**Mirlo Shelf support for Wood/Glass**  
**Wspornik półek drewnianych/szklanych Mirlo**

Finishing/Wykończenie	Packaging/Opakowanie	Cod.
Silver painted/Malowane aluminium 	20 Pair/Kpl.	4009525

Plastic, Zamak/Plastik, Znal

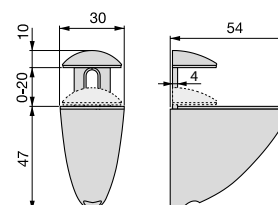

**Azor shelf support for wood/glass**  
**Wspornik półek drewnianych/szklanych Azor**

Finishing/Wykończenie	Packaging/Opakowanie	Cod.
Silver painted/Malowane aluminium 	20 Pair/Kpl.	4009425

Plastic, Zamak/Plastik, Znal

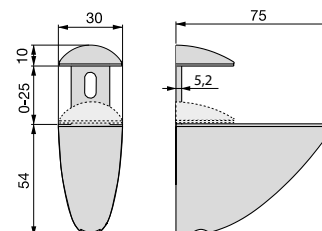
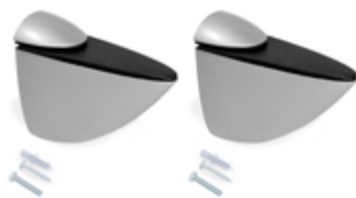

**Aguila Shelf support for Wood/Glass**  
**Wspornik półek drewnianych/szklanych Aguila**

Finishing/Wykończenie	Packaging/Opakowanie	Cod.
Silver painted/Malowane aluminium 	20 Pair/Kpl.	4009325

Plastic, Zamak/Plastik, Znal

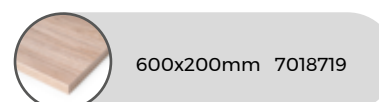
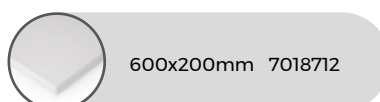
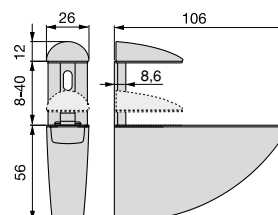

M4 screws with an extra flat head  
Śruby M4 z dodatkowym łbem płaskim

L	Finishing/Wykończenie	Packaging/Opakowanie	Cod.
10	Nickel plated/Niklowane	2000 Unit/Szt	4130107
14	Nickel plated/Niklowane	2000 Unit/Szt	4130207
20	Nickel plated/Niklowane	2000 Unit/Szt	4130307
22	Nickel plated/Niklowane	2000 Unit/Szt	4130407
25	Nickel plated/Niklowane	2000 Unit/Szt	4130507
30	Nickel plated/Niklowane	2000 Unit/Szt	4130607
40	Nickel plated/Niklowane	2000 Unit/Szt	4130807

Steel/Stal

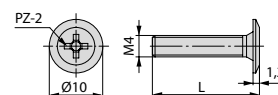

M4 bolt with an extra flat head  
Trzpień M4 z dodatkowym łbem płaskim

L	X	Finishing/Wykończenie	Packaging/Opakowanie	Cod.
15	9	Nickel plated/Niklowane	2000 Unit/Szt	4130907
29	13	Nickel plated/Niklowane	2000 Unit/Szt	4131007

Steel/Stal

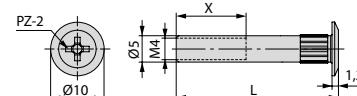

M4 sheath  
Rurka M4 do śruby z gwintem metrycznym

L	Finishing/Wykończenie	Packaging/Opakowanie	Cod.
20	Natural brass/Naturalny mosiądz	2000 Unit/Szt	9020302

Brass/Mosiądz

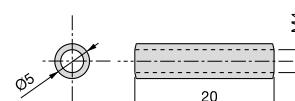

Set 2 screws + 2 bolts M4  
 Zestaw 2 śrub 2 sworzni M4

Finishing/Wykończenie	Packaging/Opakowanie	Cod.
Nickel plated/Niklowane	500 Pair/Kpl.	4131107

Steel/Stal

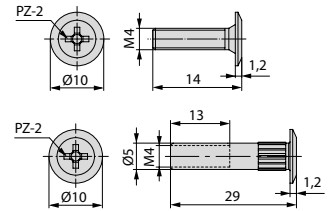

M6 screws  
 Śruba M6

L	Finishing/Wykończenie	Packaging/Opakowanie	Cod.
14	Nickel plated/Niklowane	2000 Unit/Szt	5056407
20	Nickel plated/Niklowane	2000 Unit/Szt	5022107
25	Nickel plated/Niklowane	2000 Unit/Szt	5056507
30	Nickel plated/Niklowane	2000 Unit/Szt	7050107
35	Nickel plated/Niklowane	2000 Unit/Szt	6094207
50	Nickel plated/Niklowane	1000 Unit/Szt	5132107

Steel/Stal

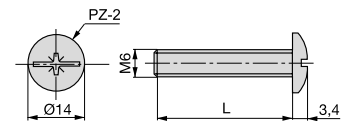

M6 bolt  
 M6 Trzpień



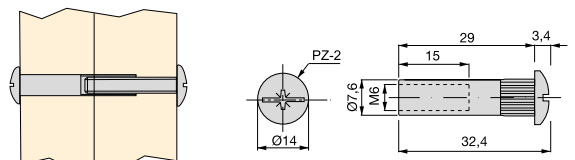

Finishing/Wykończenie	Packaging/Opakowanie	Cod.
Nickel plated/Niklowane	2000 Unit/Szt	5021307

Steel/Stal







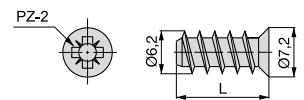

Flathead euro screws  
Eurośruby z płaskim łbem

L	Finishing/Wykończenie	Packaging/Opakowanie	Cod.
13	Zinc plated/Cynkowane 	1000 Unit/Szt	5123705
11	Zinc plated/Cynkowane 	1000 Unit/Szt	6108505
11	Nickel plated/Niklowane 	1000 Unit/Szt	6108507
13	Nickel plated/Niklowane 	1000 Unit/Szt	5123707

Steel/Stal



Fine thread flathead euro screw  
Eurośruba z gwintem drobnzwojnym z płaskim łbem

L	Finishing/Wykończenie	Packaging/Opakowanie	Cod.
12	Zinc plated/Cynkowane 	2000 Unit/Szt	8067005
13.7	Zinc plated/Cynkowane 	2000 Unit/Szt	5044105
17	Zinc plated/Cynkowane 	2000 Unit/Szt	5044005
13.7	Nickel plated/Niklowane 	2000 Unit/Szt	5044107

Steel/Stal

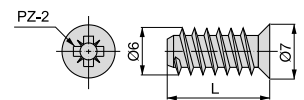

Roundhead fine thread euro screw  
Eurośruba z gwintem drobnzwojnym z płaskim łbem

L	Finishing/Wykończenie	Packaging/Opakowanie	Cod.
11	Nickel plated/Niklowane 	2000 Unit/Szt	8234207

Steel/Stal

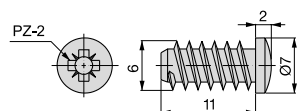

Ø7 screws  
 Śruba Ø7

L	Finishing/Wykończenie		Packaging/Opakowanie	Cod.
50	Zinc plated/Cynkowane		2000 Unit/Szt	7012105
50	Black zinc plated/Cynkowana czerni		2000 Unit/Szt	7012109
60	Black zinc plated/Cynkowana czerni		1000 Unit/Szt	7050709
70	Black zinc plated/Cynkowana czerni		1000 Unit/Szt	7013809

Steel/Stal

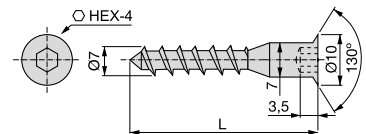

Ø5 screws  
 Śruba Ø5

L	Finishing/Wykończenie		Packaging/Opakowanie	Cod.
50	Zinc plated/Cynkowane		3000 Unit/Szt	7011905
50	Black zinc plated/Cynkowana czerni		3000 Unit/Szt	7011909

Steel/Stal

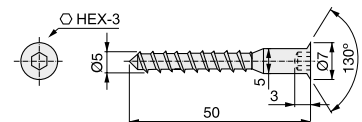

Ø5 screws  
 Śruba Ø5

L	Finishing/Wykończenie		Packaging/Opakowanie	N° pieces/Liczba elementów	Cod.
50	Zinc plated/Cynkowane		1 LOT/Partia	500 units/500 sztuk	4027705

Steel/Stal



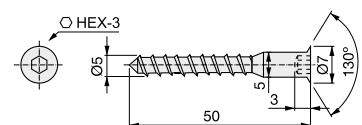

x500



## Raised-head screw

## Wkręty z łbem stożkowym

D	Diametre/Średnica	L	Finishing/Wykończenie	Packaging/Opakowanie	Cod.
7,9	4	15	Nickel plated/Niklowane 	1000 Unit/Szt	5000907
6,5	3,5	16	Nickel plated/Niklowane 	2000 Unit/Szt	5000807

Steel/Stal

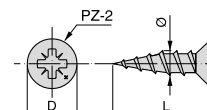

## SOCKETS / NAKRĘTKI

## Nut Pronged

## Nakrętka Z wtykiem

A	B	C	Diametre/Średnica	F	Finishing/Wykończenie	Packaging/Opakowanie	Cod.
17	6.5	8	8	M6	Zinc plated/Cynkowane 	1000 Unit/Szt	3007005
22.5	7.5	11	12	M10	Zinc plated/Cynkowane 	1000 Unit/Szt	3006805

Steel/Stal

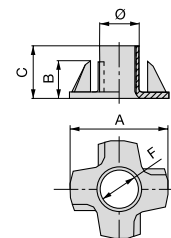

## Nut For screws

## Nakrętka Przykręcane

A	B	C	Diametre/Średnica	F	Finishing/Wykończenie	Packaging/Opakowanie	Cod.
25	3.5	12.3	10	M8	Zinc plated/Cynkowane 	1250 Unit/Szt	5044705
29	3.8	11.3	11.6	M10	Zinc plated/Cynkowane 	1250 Unit/Szt	5044605

Steel/Stal

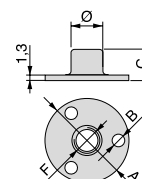

**Nut Wide rimmed**  
**Nakrętka z szerokim łbem**

C	D	Diametre/Sred-nica	L	F	Finishing/Wykończenie	Packaging/Opakowanie	Cod.
8.7	8	13.6	15.4	M6	Zinc plated/Cynkowane	1000 Unit/Szt	8066705
10.7	10	20	18	M8	Zinc plated/Cynkowane	1000 Unit/Szt	8029105
12.5	12	22	19	M10	Zinc plated/Cynkowane	1000 Unit/Szt	8035305

Steel/Stal

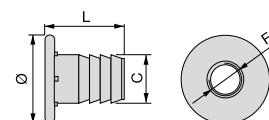
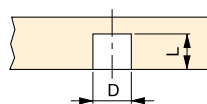

**Nut Sockets**  
**Nakrętka Gniazdko ad espansione**

Finishing/Wykończenie	Packaging/Opakowanie	Cod.
Natural brass/Naturalny mosiądz	1000 Unit/Szt	9003402

Brass/Mosiądz

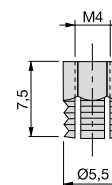
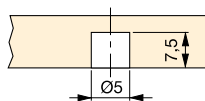

**Sockets**  
**Gniazda**

Finishing/Wykończenie	Packaging/Opakowanie	Cod.
Natural brass/Naturalny mosiądz	1000 Unit/Szt	9003302

Brass/Mosiądz

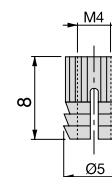
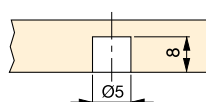

Expanding nut made of natural brass with plastic ball inside





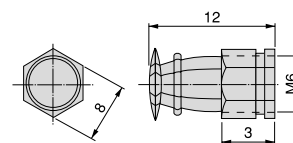
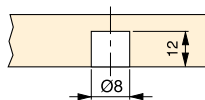

Nakrętka rozprężna wykonana z naturalnego mosiądzu z plastikową kulką wewnątrz

Finishing/Wykończenie	Packaging/Opakowanie	Cod.
Natural brass/Naturalny mosiądz 	2500 Unit/Szt	8008202

Brass/Mosiądz



Sockets  
 Gniazda

D	Diametre/Sred-nica	L	M	F	Finishing/Wykończenie	Packaging/Opakowanie	Cod.
8	9.5	10	6	EU M6	Zinc plated/Cynkowane 	1000 Unit/Szt	8028005
8	10.5	13	6	EU M6	Zinc plated/Cynkowane 	5000 Unit/Szt	8008005
8	10.5	17	6	EU M6	Zinc plated/Cynkowane 	2500 Unit/Szt	8007705
10	12	15	8	EU M8	Zinc plated/Cynkowane 	1000 Unit/Szt	8007605
8	9.5	10	6	EU M6	Natural zamak/Znal naturalny 	1000 Unit/Szt	8028001
8	10.5	13	6	EU M6	Natural zamak/Znal naturalny 	5000 Unit/Szt	8008001
10	12	15	8	EU M8	Natural zamak/Znal naturalny 	1000 Unit/Szt	8007601

Zamak/Znal

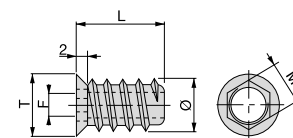
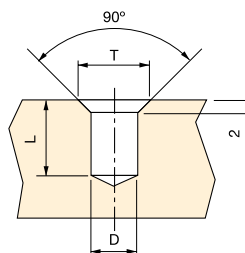

Nut connection system M4 socket  
 System łączenia M4

Finishing/Wykończenie	Packaging/Opakowanie	Cod.
Not defined/Nieokreślone 	2000 Unit/Szt	9047420

Plastic/Plastik

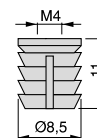
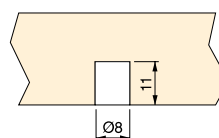

Nut connection system M6 socket  
System łączenia M6

Diametre/Srednica	L	Finishing/Wykończenie	Packaging/Opakowanie	Cod.
10	10	Not defined/Nieokreślone <input type="checkbox"/>	2500 Unit/Szt	9007920
10	13	Not defined/Nieokreślone <input type="checkbox"/>	2500 Unit/Szt	9007820

Plastic/Plastik

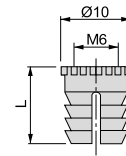
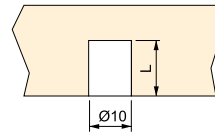

Nut connection system Ø5 Socket  
System łączenia Gniazdko Ø5

L	Finishing/Wykończenie	Packaging/Opakowanie	Cod.
10	Not defined/Nieokreślone <input type="checkbox"/>	5000 Unit/Szt	9040920
11	Not defined/Nieokreślone <input type="checkbox"/>	5000 Unit/Szt	9003620

Plastic/Plastik

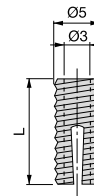
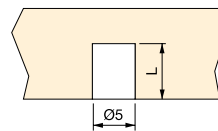

Nut connection system Housing  
System łączenia Obudowa

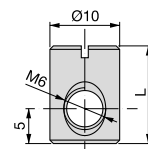

L	Finishing/Wykończenie	Packaging/Opakowanie	Cod.
14	Zinc plated/Cynkowane <input checked="" type="checkbox"/>	2000 Unit/Szt	6170105

Steel/Stal



Bumpers Ø5 to be pressed in  
 Odbojniki Ø5 do wciśnięcia

Ø5

Finishing/Wykończenie	Packaging/Opakowanie	Cod.
Grey plastic/Szary plastik 	2000 Unit/Szt	4014721
Anthracite grey plastic/Szaro-antracytowy plastik 	2000 Unit/Szt	4014723

Plastic/Plastik

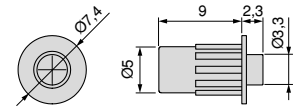
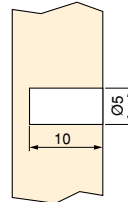

T bumpers bumper  
 Odbojniki Odbojniki T

Finishing/Wykończenie	Packaging/Opakowanie	Cod.
Not defined/Nieokreślone 	1000 Unit/Szt	9016620

Plastic/Plastik

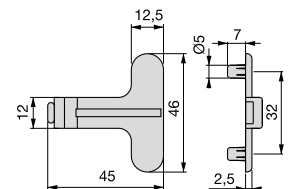
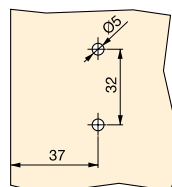

**Bumpers**  
**Odbojniki Z miękkim rdzeniem**

Finishing/Wykończenie	Packaging/Opakowanie	Cod.
Not defined/Nieokreślone	5000 Unit/Szt	9069820

Plastic/Plastik

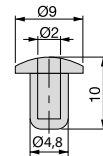
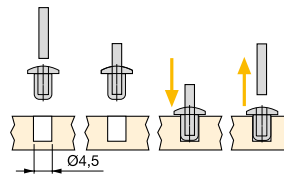

**Soft-stem bumper**  
**Odbojniki Z miękkim rdzeniem**

Finishing/Wykończenie	Packaging/Opakowanie	Cod.
Not defined/Nieokreślone	5000 Unit/Szt	9017320

Plastic/Plastik

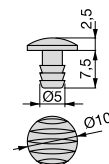
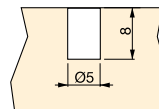

**Soft-stem bumper**  
**Odbojniki Z miękkim rdzeniem**

Finishing/Wykończenie	Packaging/Opakowanie	Cod.
White plastic/Biały plastik	5000 Unit/Szt	9017415

Plastic/Plastik

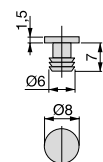
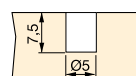



Adhesive bumpers  
Odbojniki Z miękkim rdzeniem

A	B	Finishing/Wykończenie	Packaging/Opakowanie	Cod.
10	3	Not defined/Nieokreślone <input type="checkbox"/>	2500 Unit/Szt	3005720
10	1.5	Not defined/Nieokreślone <input type="checkbox"/>	5000 Unit/Szt	8171020
7	1.5	Not defined/Nieokreślone <input type="checkbox"/>	5000 Unit/Szt	3005920

Plastic/Plastik

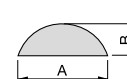
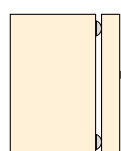

COVERCAPS / ZAŚLEPKI

Grooved plastic Bumper cap  
Odbojnik Rowkowane plastik

A	B	C	Finishing/Wykończenie	Packaging/Opakowanie	Cod.
8	5	5	White plastic/Biały plastik <input type="checkbox"/>	1000 Unit/Szt	9017615

Plastic/Plastik

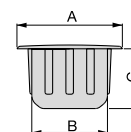

Adhesive caps bumper  
odbojniki Zaślepka do przyklejenia



Diametre/Średnica	Finishing/Wykończenie		Packaging/Opakowanie	N° pieces/Liczba elementów	Cod.
13	White plastic/Biały plastik		1000 Unit/Szt	20 units. / sheet/20 szt. / arkusz	5128915
20	White plastic/Biały plastik		900 Unit/Szt	15 units. / sheet/15 szt. / arkusz	5136015
13	Brown plastic/Brązowy plastik		1000 Unit/Szt	20 units. / sheet/20 szt. / arkusz	5128916
20	Brown plastic/Brązowy plastik		900 Unit/Szt	15 units. / sheet/15 szt. / arkusz	5136016
13	Black plastic/Czarny plastik		1000 Unit/Szt	20 units. / sheet/20 szt. / arkusz	5128917
20	Black plastic/Czarny plastik		900 Unit/Szt	15 units. / sheet/15 szt. / arkusz	5136017
13	Ash effect/Efekt jesion		1000 Unit/Szt	20 units. / sheet/20 szt. / arkusz	5128918
20	Ash effect/Efekt jesion		900 Unit/Szt	15 units. / sheet/15 szt. / arkusz	5136018
13	Oak effect/Efekt dąb		1000 Unit/Szt	20 units. / sheet/20 szt. / arkusz	5128919
13	Grey textil effect/Efekt szarej tkaniny		1000 Unit/Szt	20 units. / sheet/20 szt. / arkusz	5128927
20	Oak effect/Efekt dąb		900 Unit/Szt	15 units. / sheet/15 szt. / arkusz	5136019
13	Grey plastic/Szary plastik		1000 Unit/Szt	20 units. / sheet/20 szt. / arkusz	5128921
20	Grey plastic/Szary plastik		900 Unit/Szt	15 units. / sheet/15 szt. / arkusz	5136021
13	Beige plastic/Beżowy plastik		1000 Unit/Szt	20 units. / sheet/20 szt. / arkusz	5128922
20	Beige plastic/Beżowy plastik		900 Unit/Szt	15 units. / sheet/15 szt. / arkusz	5136022
13	Anthracite grey plastic/Szaro-antracytowy plastik		1000 Unit/Szt	20 units. / sheet/20 szt. / arkusz	5128923
20	Anthracite grey plastic/Szaro-antracytowy plastik		900 Unit/Szt	15 units. / sheet/15 szt. / arkusz	5136023
13	Cherry wood effect/Efekt drzewa wiśniowego		1000 Unit/Szt	20 units. / sheet/20 szt. / arkusz	5128926
20	Cherry wood effect/Efekt drzewa wiśniowego		900 Unit/Szt	15 units. / sheet/15 szt. / arkusz	5136026
20	Grey textil effect/Efekt szarej tkaniny		900 Unit/Szt	15 units. / sheet/15 szt. / arkusz	5136027
13	Beige textil effect/Efekt beżowej tkaniny		1000 Unit/Szt	20 units. / sheet/20 szt. / arkusz	5128928
20	Beige textil effect/Efekt beżowej tkaniny		900 Unit/Szt	15 units. / sheet/15 szt. / arkusz	5136028
20	Beech effect/Efekt buku		900 Unit/Szt	15 units. / sheet/15 szt. / arkusz	5136030
13	Beech effect/Efekt buku		1000 Unit/Szt	20 units. / sheet/20 szt. / arkusz	5128930
13	Pine effect/Efekt sosna		1000 Unit/Szt	20 units. / sheet/20 szt. / arkusz	5128950
20	Wengue effect/Efekt wengue		900 Unit/Szt	15 units. / sheet/15 szt. / arkusz	5136083
13	Wengue effect/Efekt wengue		1000 Unit/Szt	20 units. / sheet/20 szt. / arkusz	5128983

Plastic/Plastik

