

Lighting / Oświetlenie

LED Strips

629	Lynx Premium (12V DC)
632	Lynx Premium COB (12V DC)
633	Lynx Premium RGB (12V DC)
634	Lynx Basic (12V DC)
636	Lynx connectors (12V DC)
640	Lynx Premium (24V DC)
641	Lynx Premium COB (24V DC)
643	Neonlynx (24 V DC)
646	Lynx connectors (24V DC)
651	Sensors Lynx (12V DC) (24V DC)
653	Profiles Lynx W
656	Profiles Lynx

LED lights

663	Drawer lighting Illuminated mirrors
670	Bathroom lights
673	Battery operated
677	Illuminated hanging bars
679	Lights
681	Spots

Drivers and detectors

686	Drivers
688	Detectors
695	LED light controllers
699	Switches
698	Cables

Office

701	Chargers
705	Connectors
714	Cable profile
716	TV supports
718	Extending keyboard shelf runner

Taśmy LED

629	Lynx Premium (12V DC)
632	Lynx Premium COB (12V DC)
633	Lynx Premium RGB (12V DC)
634	Lynx Basic (12V DC)
636	Złącza Lynx (12V DC)
640	Lynx Premium (24V DC)
641	Lynx Premium COB (24V DC)
643	Neonlynx (24 V DC)
646	Złącza Lynx (24V DC)
651	Czujniki Lynx (12V DC) (24V DC)
653	Profile Lynx W
656	Profile Lynx

Światła LED

663	Oświetlenie szuflad Podświetlane lustra
670	Oświetlenie łazienkowe
673	Z baterią
677	Podświetlane drążki na wieszaki
679	Kinkiety
681	Punkt

Konwertory i czujniki

686	Konwertory
688	Czujniki
695	Sterowniki oświetlenia LED
699	Przełączniki, wyłączniki
698	Kable

Gabinet

701	Ładowarki
705	Złącza
714	Przepusty kablowe
716	Wsporniki na telewizory
718	Prowadnice do półek na klawiaturę

Lighting information Informacje o oświetleniu

General information / Informacje ogólne



The product complies with the European Directives: LVD 2014-35-EU, EMC 2014-30-EU and RoHS 2011/65/EU.
Produkt jest zgodny z dyrektywami europejskimi: LVD 2014-35-UE, EMC 2014-30-UE i RoHS 2011/65/UE.



Insulation in which the protection against electric shock is provided by the main insulation and a protective earthed conductor.

Izolacja, w której ochrona przed porażeniem prądem jest zapewniona przez główną izolację i przewód ochronny.



Class II insulation protected against electric shock from direct and indirect contact. No earth connection is required.

Izolacja klasy II chroniąca przed porażeniem prądem elektrycznym w wyniku bezpośredniego i pośredniego kontaktu. Nie jest wymagane podłączenie uziemienia.



Very low voltage safety class III apparatus. Very low voltage apparatus must not be connected to earthed conductors.

Aparatura niskonapięciowa klasy bezpieczeństwa III. Urządzeń o bardzo niskim napięciu nie wolno podłączać do uziemionych przewodów.



Suitable for mounting on surfaces made of materials whose flammability characteristics are not known (e.g. wood).

Nadaje się do montażu na powierzchniach wykonanych z materiałów, których właściwości palne nie są znane (np. drewno).



Apply suitable for installation in or on normally flammable surfaces.

Nadaje się do montażu w lub na powierzchniach normalnie łatwopalnych.



To protect the environment, do not dispose of the luminaire in a container at the end of its service life, but take it to the specific collection points provided for by law.

W celu ochrony środowiska nie należy wyrzucać oprawy oświetleniowej do pojemnika po zakończeniu okresu eksploatacji, lecz oddać ją do specjalnych punktów zbiórki przewidzianych przez prawo.

Converters / Konwertery

An essential addition to your installation are the power converters for your LED lights.

Niezbędnym dodatkiem do instalacji są konwertery zasilania dla świateł LED.

12V DC

6W	5211020
15W	521120
30W	5147420
50W	5147520
72W	5008520
100W	5209320
200W	5209420

AC 230V 50Hz

Luminaires that work at 230V AC, do not need a converter.

Oprawy zasilane napięciem 230V AC nie wymagają konwertera.

24V DC

15W	5211220
30W	5147620
50W	5147720
100W	5209520

5V DC

Luminaires that have a rechargeable battery with a 5V DC mobile charger.

Oprawy, które mają akumulator z przenośną ładowarką 5V DC.

Sensors / Czujniki



Concealed switch sensor / Ukryty czujnik przełączający

Concealed proximity detection system, which switches the luminaire on or off when it interferes with its detection range. Without timer.

Ukryty system wykrywania zbliżeniowego, który włącza lub wyłącza oprawę oświetleniową, gdy jej zasięg wykrywania zostanie zakłócony. Bez wyłącznika czasowego.



Switch sensor / Czujnik przełącznikowy

Proximity detection system, which switches the luminaire on or off when its detection range is interfered with. Without timer.

System detekcji zbliżeniowej, który włącza lub wyłącza oprawę oświetleniową, gdy jej zasięg detekcji zostanie zakłócony. Bez timera.



Proximity sensor / Czujnik zbliżeniowy

Proximity detection system for doors that keeps the luminaire switched on and only switches off when its detection range is interfered with. Without timer.

System detekcji zbliżeniowej do drzwi, który utrzymuje oprawę oświetleniową włączoną i wyłącza się tylko wtedy, gdy jej zasięg wykrywania zostanie zakłócony. Bez timera.



Motion sensor / Czujnik ruchu

Motion detection system, which switches the luminaire on when its detection range is interfered with. And it has a timer for switching off the luminaire.

System wykrywania ruchu, który włącza oprawę oświetleniową, gdy jej zasięg wykrywania zostanie zakłócony. Posiada zegar wyłączający oprawę.



Touch sensor / Czujnik dotykowy

Contact detection system, which switches the luminaire on by touch. The detection range and/or operation is adjustable according to need.

System wykrywania dotyku, który włącza oprawę za pomocą dotyku. Zakres wykrywania i/lub działania można regulować w zależności od potrzeb.



Switch sensor / Czujnik przełączający

Radio frequency remote control system that switches the luminaire on. It also has a timer to switch off the luminaire.

System zdalnego sterowania o częstotliwości radiowej, który włącza oprawę oświetleniową. Posiada również timer do wyłączania oprawy.



Vibration sensor / Czujnik wibracji

System that detects the vibration of the drawer when it is opened and switches the luminaire on and then switches it off automatically thanks to its timer.

System wykrywający wibracje szuflady podczas jej otwierania i włączający oprawę, a następnie wyłączający ją automatycznie dzięki timerowi.

Colour temperature / Temperatura barwowa

KELVIN

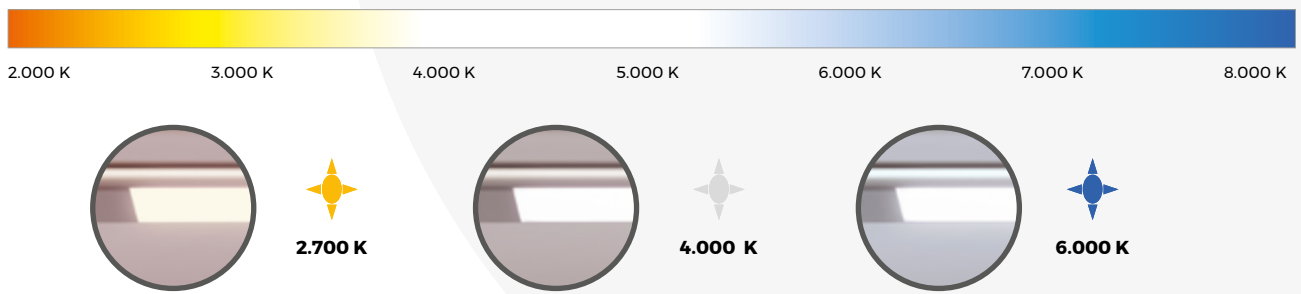

Degree of protection / Stopień ochrony

IP **X** **X**

0	—	0	
1		1	
2		2	
3		3	
4		4	
5		5	
6		6	
		7	
		8	

Degree of protection against solids
Stopień ochrony przed ciałami stałymi

Degree of protection against liquids
Stopień ochrony przed cieczami

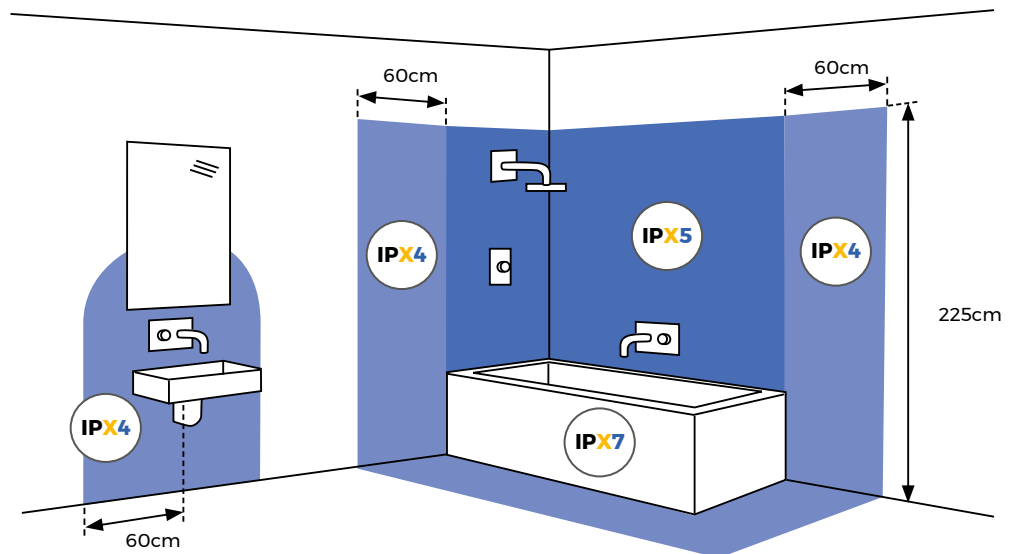

LED strip packaging / Opakowanie taśm LED



In line with our commitment to sustainability, we are changing the packaging of LED strips from plastic to cardboard. We continue on our path towards inclusive and sustainable industrialisation. SDG 12 (Sustainable Development Goals) focuses on promoting efficiency in the use of natural resources, such as cardboard in this case, to reduce the environmental impact of our projects.

Zgodnie z naszym zaangażowaniem w zrównoważony rozwój, zmieniamy opakowania taśm LED z plastikowych na kartonowe. Kontynuujemy naszą drogę w kierunku zrównoważonej industrializacji sprzyjającej włączeniu społecznemu. SDG 12 (Cele Zrównoważonego Rozwoju) koncentruje się na promowaniu efektywności wykorzystania zasobów naturalnych, takich jak tektura w tym przypadku, w celu zmniejszenia wpływu naszych projektów na środowisko.

LED Strips Taśmy LED

What do I need for an installation?
Czego potrzebuję do instalacji?

- 1
- 2
- 3
- 4

1 An LED strip / Taśma LED

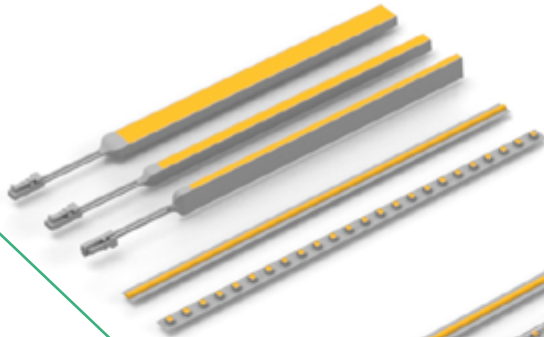

Lynx Premium 24V DC

24V DC LED strips are perfect for use in long commercial installations due to their better performance in these situations.

Taśmy LED 24 V DC są idealne do stosowania w długich instalacjach komercyjnych ze względu na ich lepszą wydajność w takich sytuacjach.

12V DC LED strips are ideal for use in furniture or short length installations where a more precise fit is required.

Taśmy LED 12V DC są idealne do stosowania w meblach lub instalacjach o niewielkiej długości, gdzie wymagane jest bardziej precyzyjne dopasowanie.



Lynx Premium 12V DC

Lynx Basic 12V DC

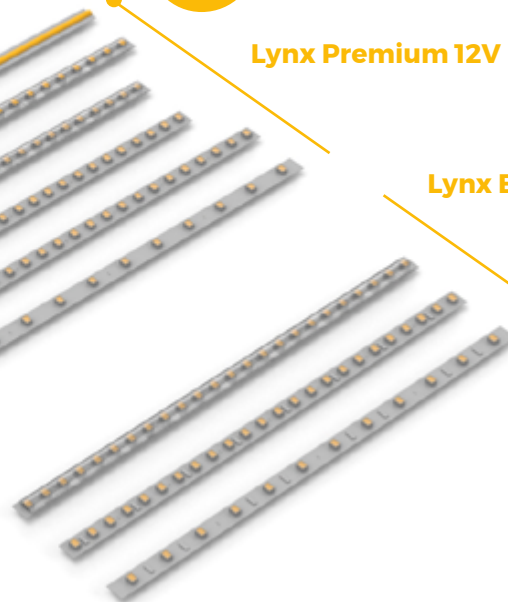

2 One cable or sensor / Jeden kabel lub czujnik

Lynx 24V DC



Lynx 12V DC

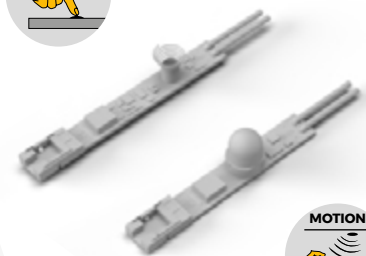

3

One converter / Jeden konwerter

Converter for luminaires or devices operating on direct current to 12 V DC.

Konwerter do opraw oświetleniowych lub urządzeń zasilanych prądem stałym na napięcie 12 V DC.



12V DC

6W	5211020
15W	5211120
30W	5147420
50W	5147520
72W	5008520
100W	5209320
200W	5209420

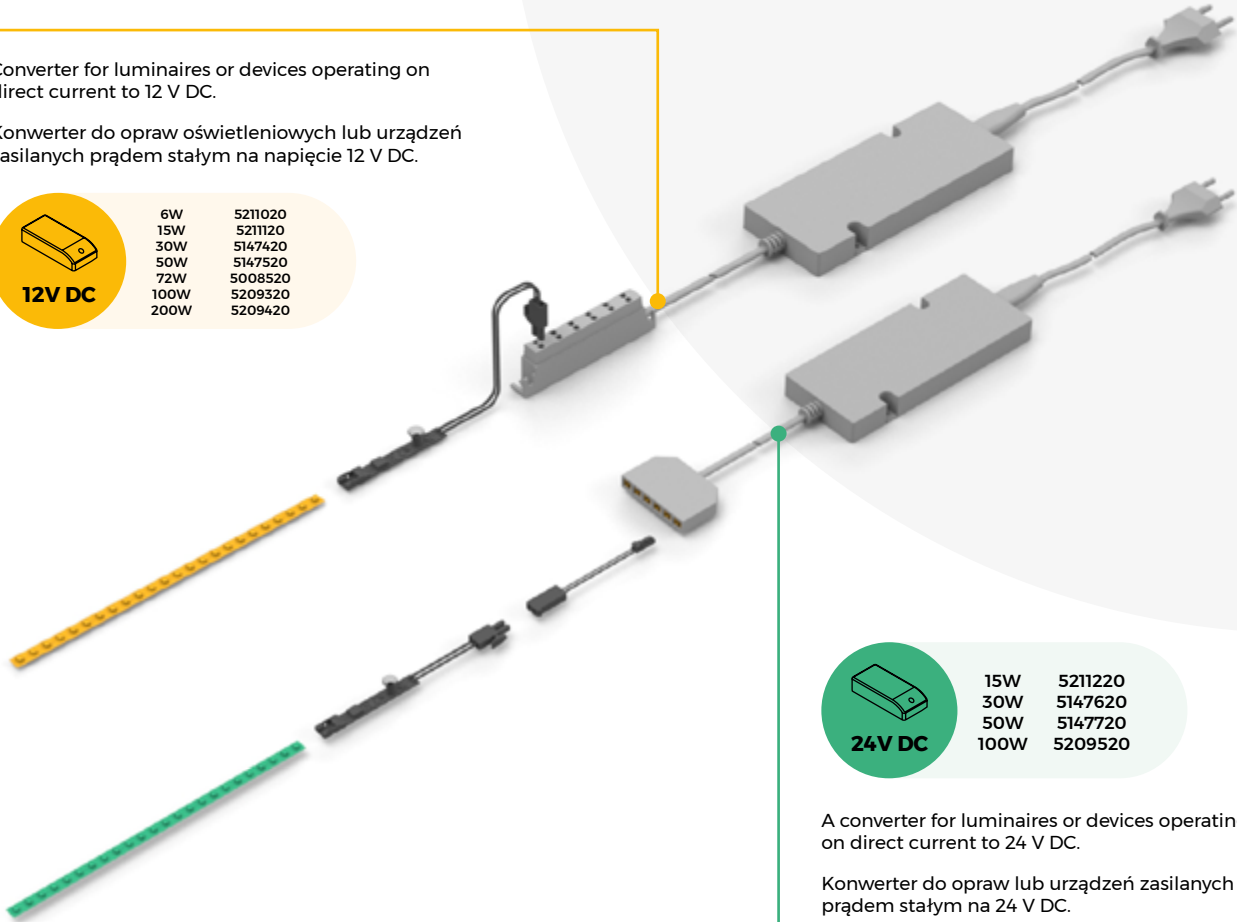

24V DC

15W	5211220
30W	5147620
50W	5147720
100W	5209520

A converter for luminaires or devices operating on direct current to 24 V DC.

Konwerter do opraw lub urządzeń zasilanych prądem stałym na 24 V DC.

4

A profile for your luminaire / Profil dla oprawy oświetleniowej

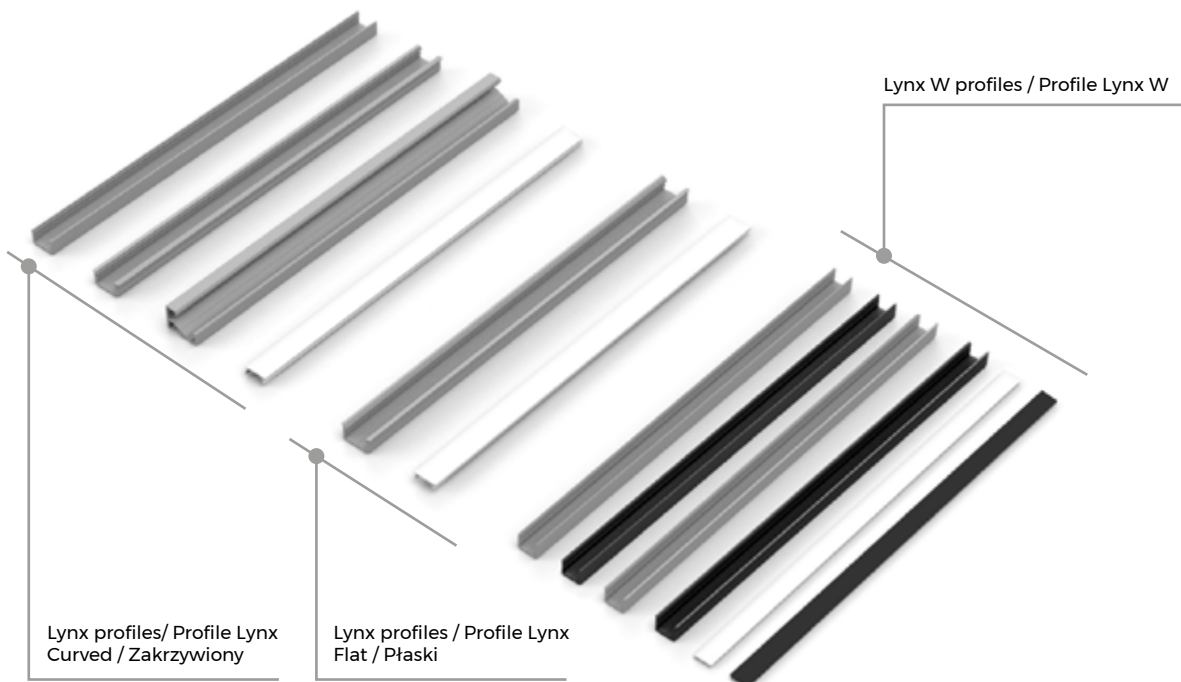

Lynx W profiles / Profile Lynx W

Lynx profiles / Profile Lynx
Curved / Zakrzywiony

Lynx profiles / Profile Lynx
Flat / Płaski

LED Strips Lynx Premium 12V DC Taśmy LED Lynx Premium 12V DC

Lynx Premium LED strips are designed for installations where intensive use is required, as they have good efficiency and high performance.

Taśmy LED Lynx Premium są przeznaczone do instalacji, w których wymagane jest intensywne użytkowanie, ponieważ charakteryzują się dobrą wydajnością i wysoką sprawnością.

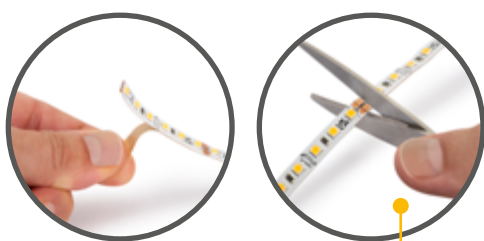

6W	5211020
15W	5211120
30W	5147420
50W	5147520
72W	5008520
100W	5209320
200W	5209420

The 3M® 300LSE adhesive tape provides the best adhesion.

Taśma samoprzylepna 3M® 300LSE zapewnia najlepszą przyczepność.

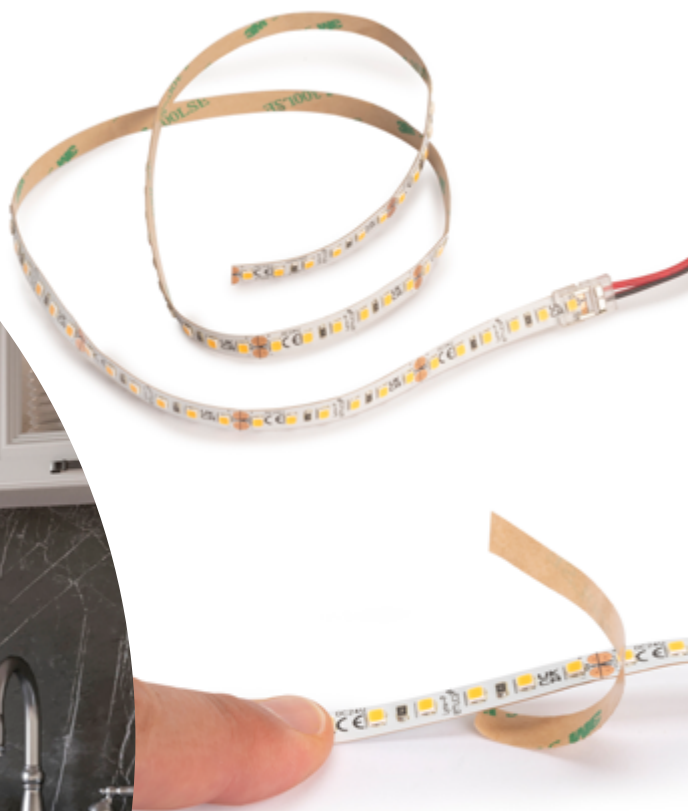

LED Strip Lynx Premium 4,8W/m IP20 (12V DC)

Taśma LED Lynx Premium 9,6 W/m IP20 (12V DC)

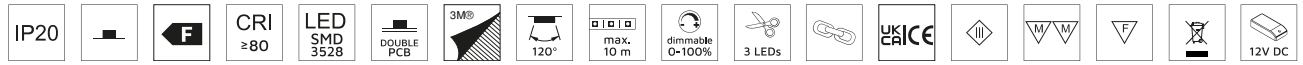

L	Efficiency/ Wydajność	Lumen	Power/Moc	Colour temperature/ Temperatura koloru	LEDs	Finishing/Wykończenie	Packaging/ Opakowanie	Cod.
5 m	112 lm / W	539 lm / m	4,8 W / m	Cold white 6.000 K/ Zimna biel 6.000 K	60 LEDs / m	Not defined/ Nieokreślone	2 Unit/Szt	5220420
10 m	114 lm / W	546 lm / m	4,8 W / m	Natural white 4.000 K/ Naturalna biel 4.000 K	60 LEDs / m	Not defined/ Nieokreślone	1 Unit/Szt	5220520
5 m	109 lm / W	525 lm / m	4,8 W / m	Warm white 3.000 K/ Ciepła biel 3.000 K	60 LEDs / m	Not defined/ Nieokreślone	2 Unit/Szt	5220620

Plastic/Plastik

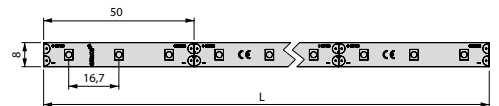
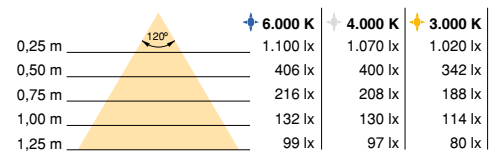

LED Strip Lynx Premium 9,6W/m IP20 (12V DC)

Taśma LED Lynx Premium 9,6W/m IP20 (12V DC)

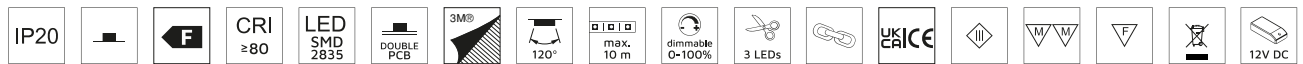

L	Efficiency/ Wydajność	Lumen	Power/Moc	Colour temperature/ Temperatura koloru	LEDs	Finishing/Wykończenie	Packaging/ Opakowanie	Cod.
5 m	119 lm / W	1.138 lm / m	9,6 W / m	Cold white 6.000 K/ Zimna biel 6.000 K	120 LEDs / m	Not defined/ Nieokreślone	2 Unit/Szt	5210020
50 m	119 lm / W	1.138 lm / m	9,6 W / m	Cold white 6.000 K/ Zimna biel 6.000 K	120 LEDs / m	Not defined/ Nieokreślone	1 Unit/Szt	5215420
10 m	110 lm / W	1.053 lm / m	9,6 W / m	Natural white 4.000 K/ Naturalna biel 4.000 K	120 LEDs / m	Not defined/ Nieokreślone	1 Unit/Szt	5210120
50 m	110 lm / W	1.053 lm / m	9,6 W / m	Natural white 4.000 K/ Naturalna biel 4.000 K	120 LEDs / m	Not defined/ Nieokreślone	1 Unit/Szt	5215520
5 m	106 lm / W	1.018 lm / m	9,6 W / m	Warm white 3.000 K/ Ciepła biel 3.000 K	120 LEDs / m	Not defined/ Nieokreślone	2 Unit/Szt	5210220
50 m	106 lm / W	1.018 lm / m	9,6 W / m	Warm white 3.000 K/ Ciepła biel 3.000 K	120 LEDs / m	Not defined/ Nieokreślone	1 Unit/Szt	5215620

Plastic/Plastik

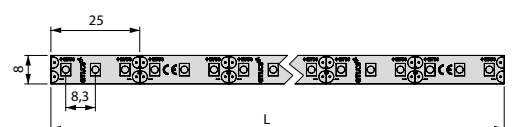
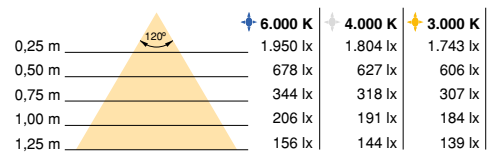
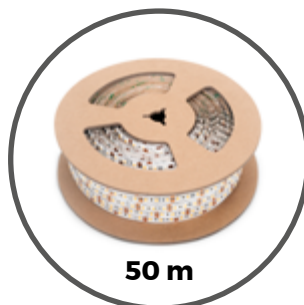
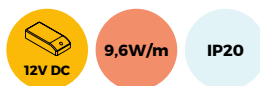

LED Strip Lynx Premium 9,6W/m IP65 (12V DC)

Taśma LED Wave 10

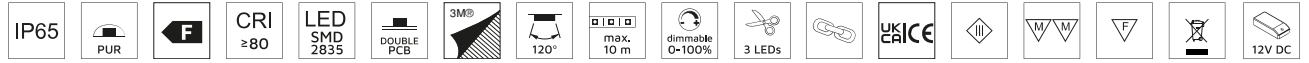

L	Efficiency/ Wydajność	Lumen	Power/Moc	Colour temperature/ Temperatura koloru	LEDs	Finishing/Wykończenie	Packaging/ Opakowanie	Cod.
10 m	101 lm / W	969 lm/m	9.6 W / m	Cold white 6.000 K/ Zimna biel 6.000 K	120 LEDs / m	Not defined/ Nieokreślone	1 Unit/Szt	5210720
5 m	97 lm / W	932 lm / m	9.6 W / m	Warm white 3.000 K/ Ciepła biel 3.000 K	120 LEDs / m	Not defined/ Nieokreślone	2 Unit/Szt	5210820

Plastic/Plastik

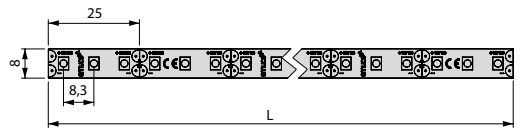
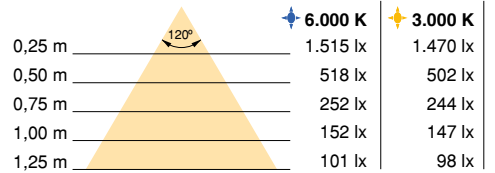

LED Strip Lynx Premium 14,4W/m IP20 (12V DC)

Taśma LED Lynx Premium 14,4W/m IP20 (12V DC)

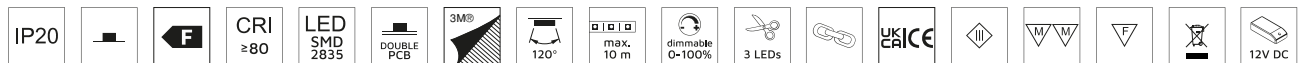

L	Efficiency/ Wydajność	Lumen	Power/Moc	Colour temperature/ Temperatura koloru	LEDs	Finishing/Wykończenie	Packaging/ Opakowanie	Cod.
5 m	121 lm / W	1.742 lm / m	14,4 W / m	Cold white 6.000 K/ Zimna biel 6.000 K	60 LEDs / m	Not defined/ Nieokreślone	2 Unit/Szt	5209620
5 m	140 lm / W	2.016 lm / m	14,4 W / m	Natural white 4.000 K/ Naturalna biel 4.000 K	60 LEDs / m	Not defined/ Nieokreślone	2 Unit/Szt	5209720
5 m	138 lm / W	1.988 lm / m	14,4 W / m	Warm white 3.000 K/ Ciepła biel 3.000 K	60 LEDs / m	Not defined/ Nieokreślone	2 Unit/Szt	5209820

Plastic/Plastik

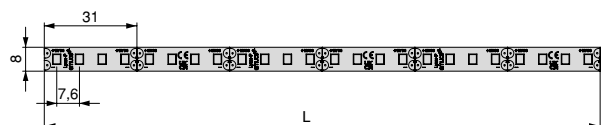
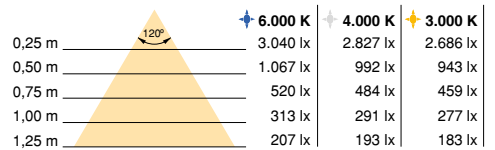

LED Strip Lynx Premium 14,4W/m IP65 (12V DC)

Taśma LED Lynx Premium 14,4W/m IP65 (12V DC)

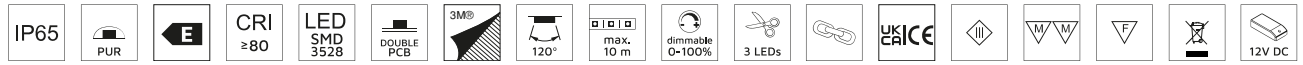

L	Efficiency/ Wydajność	Lumen	Power/Moc	Colour temperature/ Temperatura koloru	LEDs	Finishing/Wykończenie	Packaging/ Opakowanie	Cod.
5 m	126 lm / W	1.808 lm / m	14,4 W / m	Natural white 4.000 K/ Naturalna biel 4.000 K	60 LEDs / m	Not defined/ Nieokreślone	2 Unit/Szt	5209920

Plastic/Plastik

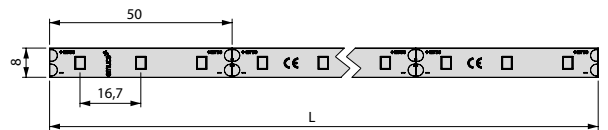
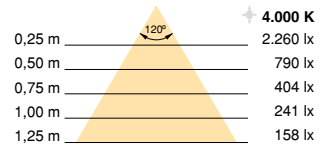

LED Strip kit Lynx Premium 9,6W/m IP20 (12V DC)

Zestaw taśm LED Lynx Premium 9,6W/m IP20 (12V DC)

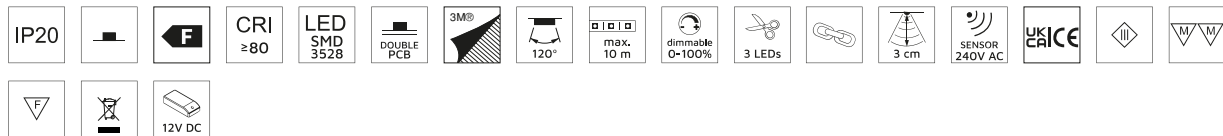

Description/Opis	Finishing/Wykończenie	Packaging/Opakowanie	Cod.
DOOR	Not defined/Nieokreślone	1 Unit/Szt	5049020
SWITCH	Not defined/Nieokreślone	1 Unit/Szt	5049120

Plastic/Plastik



This kit includes everything needed for installation: a 5m Lynx Premium 9.6W/m IP20 LED strip, 2 H cables, 2 30W converters (12V DC) and 2 sensors (depending on model).

Zestaw zawiera wszystko, co potrzebne do instalacji: 5-metrową taśmę LED Lynx Premium 9,6 W/m IP20, 2 kable H, 2 konwertery 30 W (12 V DC) i 2 czujniki (w zależności od modelu).

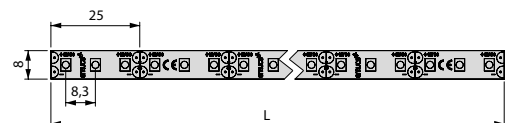
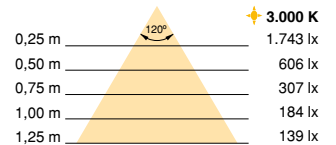
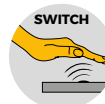
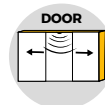

Tiras LED Lynx Premium COB 12V DC

Fitas LED Lynx Premium COB 12V DC

La tira LED Lynx Premium COB ha sido diseñada con una línea continua conocida como Chip On Board, que genera una luz LED uniforme y sin puntos.

A fita LED Lynx Premium COB está desenhada com uma linha continua conhecida como Chip On Board, que gera uma luz uniforme e sem pontos LED.

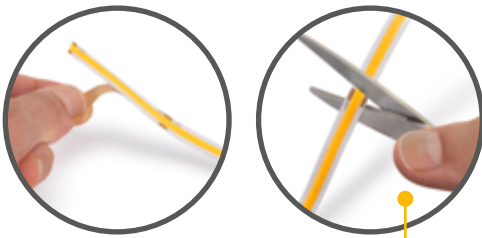

12V DC

6W	5211020
15W	5211120
30W	5147420
50W	5147520
72W	5008520
100W	5209320
200W	5209420

Destaca su alta luminosidad y continuidad lumínica.

Destaca a sua elevada luminosidade e continuidade luminosa.



LED Strip Lynx Premium COB 4,8 W/m IP20 (12V DC)

Taśma LED Lynx Premium COB 4,8 W/m IP20 (12V DC)

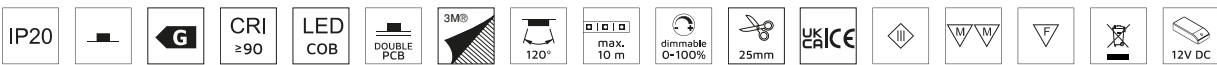

L	Efficiency/Wydajność	Lumen	Power/Moc	Colour temperature/Temperatura koloru	LEDs	Finishing/Wykończenie	Packaging/Opakowanie	Cod.
10 m	104 lm / W	501 lm / m	4,8 W / m	Cold white 6.000 K/ Zimna biel 6.000 K	320 LEDs / m	Not defined/ Nieokreślone	1 Unit/Szt	5220720
50 m	104 lm / W	501 lm / m	4,8 W / m	Cold white 6.000 K/ Zimna biel 6.000 K	320 LEDs / m	Not defined/ Nieokreślone	1 Unit/Szt	5220820

Plastic/Plastik

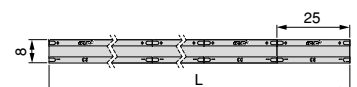
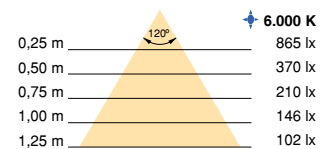

LED Strip Lynx Premium RGB 14,4W/m IP65 (12V DC)

Taśma LED Lynx Premium RGB 14,4W/m IP65 (12V DC)

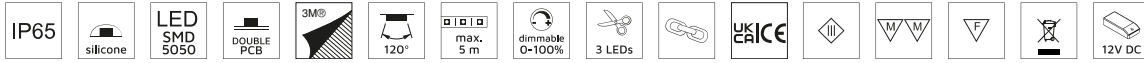

L	Efficiency/ Wydajność	Lumen	Power/Moc	Colour temperature/ Temperatura koloru	LEDs	Finishing/Wykończenie	Packaging/ Opakowanie	Cod.
5 m	67 lm / W	960 lm / m	14,4 W / m	RGB	60 LEDs / m	Not defined/ Nieokreślone	1 Unit/Szt	5200020

Plastic/Plastik

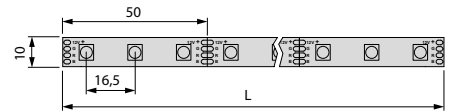
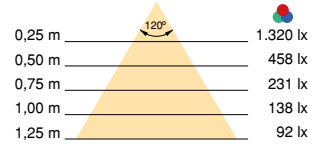

Cable RGB for LED strip (12V DC)

Kabel RGB (12V DC)

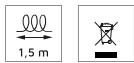

Power/Moc	Input	Output	Finishing/Wykończenie	Packaging/Opakowanie	Cod.
36W	12V DC	12V DC	Not defined/ Nieokreślone	5 Unit/Szt	5020620

Plastic/Plastik

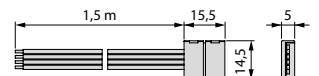

Connector RGB for RGB LED strips (12V DC)

Złącze RGB (12V DC)



Power/Moc	Input	Output	Finishing/Wykończenie	Packaging/Opakowanie	Cod.
36W/72W	12/24V DC	12/24V DC	Not defined/ Nieokreślone	5 Unit/Szt	5020920

Plastic/Plastik

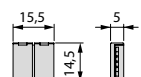

LED Strip Lynx Basic 4,8W/m IP20 (12V DC)

Taśma LED Lynx Basic 4,8W/m IP20

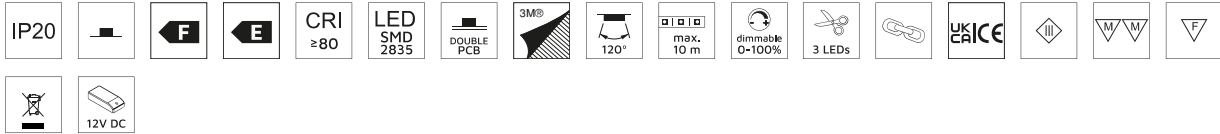

L	Efficiency/ Wydajność	Lumen	Power/Moc	Colour temperature/ Temperatura koloru	LEDs	Finishing/Wykończenie	Packaging/ Opakowanie	Cod.
5 m	E (133 lm / W)	637 lm / m	4,8 W / m	Cold white 6.000 K / Zimna biel 6.000 K	60 LEDs / m	Not defined/ Nieokreślone	2 Unit/Szt	5213120
5 m	E (122 lm / W)	589 lm / m	4,8 W / m	Natural white 4.000 K / Naturalna biel 4.000 K	60 LEDs / m	Not defined/ Nieokreślone	2 Unit/Szt	5215720
5 m	F (121 lm / W)	584 lm / m	4,8 W / m	Warm white 3.000 K / Ciepła biel 3.000 K	60 LEDs / m	Not defined/ Nieokreślone	2 Unit/Szt	5213220

Plastic/Plastik

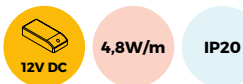

	6.000 K	4.000 K	3.000 K
0,25 m	1.510 lx	1.480 lx	1.470 lx
0,50 m	625 lx	613 lx	600 lx
0,75 m	358 lx	351 lx	352 lx
1,00 m	222 lx	218 lx	220 lx
1,25 m	160 lx	157 lx	152 lx

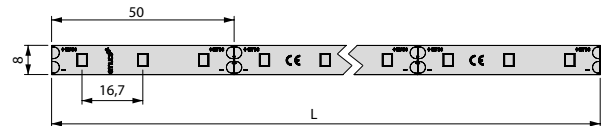

LED Strip Lynx Basic 9,6W/m IP20 (12V DC)

Taśma LED Lynx Basic 9,6W/m IP20

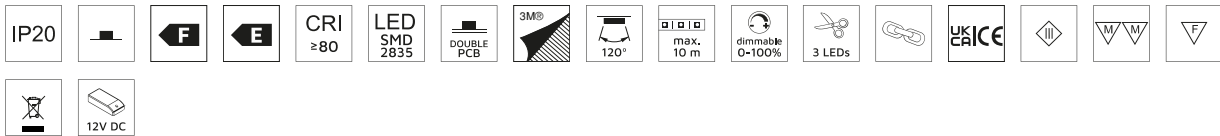

L	Efficiency/ Wydajność	Lumen	Power/Moc	Colour temperature/ Temperatura koloru	LEDs	Finishing/Wykończenie	Packaging/ Opakowanie	Cod.
5 m	E (119 lm / W)	1.140 lm / m	9,6 W / m	Cold white 6.000 K / Zimna biel 6.000 K	120 LEDs / m	Not defined/ Nieokreślone	2 Unit/Szt	5213320
5 m	E (124 lm / W)	1.195 lm / m	9,6 W / m	Natural white 4.000 K / Naturalna biel 4.000 K	120 LEDs / m	Not defined/ Nieokreślone	2 Unit/Szt	5215820
5 m	F (118 lm / W)	1.138 lm / m	9,6 W / m	Warm white 3.000 K / Ciepła biel 3.000 K	120 LEDs / m	Not defined/ Nieokreślone	2 Unit/Szt	5214720

Plastic/Plastik

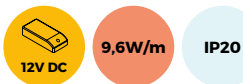

	6.000 K	4.000 K	3.000 K
0,25 m	2.480 lx	2.406 lx	2.760 lx
0,50 m	990 lx	960 lx	825 lx
0,75 m	565 lx	548 lx	498 lx
1,00 m	354 lx	343 lx	268 lx
1,25 m	256 lx	248 lx	200 lx

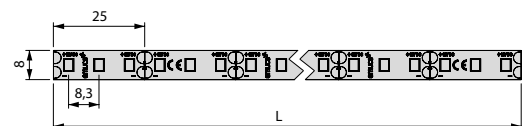

LED Strip Lynx Basic 9,6W/m IP65 (12V DC)
Taśma LED Lynx Basic 9,6W/m IP65



L	Efficiency/Wydajność	Lumen	Power/Moc	Colour temperature/Temperatur koloru	LEDs	Finishing/Wykończenie	Packaging/Opakowanie	Cod.
5 m	103 lm / W	985 lm / m	9,6 W / m	Cold white 6.000 K / Zimna biel 6.000 K	120 LEDs / m	Not defined/ Nieokreślone	2 Unit/Szt	5214820
5 m	107 lm / W	1.031 lm / m	9,6 W / m	Warm white 3.000 K / Ciepła biel 3.000 K	120 LEDs / m	Not defined/ Nieokreślone	2 Unit/Szt	5214920

Plastic/Plastik

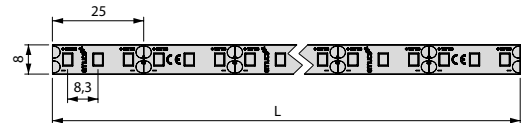
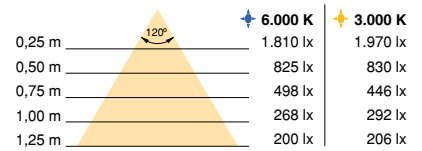

6W	5211020
15W	5211120
30W	5147420
50W	5147520
72W	5008520
100W	5209320
200W	5209420



An essential addition to your installation are the power transformers for your LED lights. They should be small enough to be hidden in the furniture.

Niezbędnym uzupełnieniem instalacji są transformatory zasilające dla świateł LED. Powinny one być na tyle małe, aby można je było ukryć w meblach.



Lynx Z cable LED (12V DC)

Kabel LED Lynx Z (12V DC)

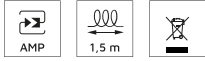

Power/Moc	Input	Output	Finishing/Wykończenie	Packaging/Opakowanie	Cod.
60W	12V DC	12V DC	Not defined/Nieokreślone	10 Unit/Szt	5207820

Plastic/Plastik

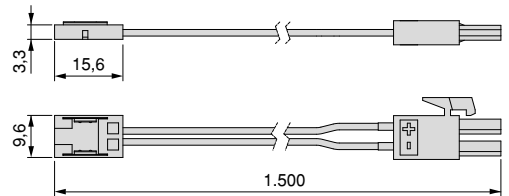

Lynx Z connector LED (12V DC) (24V DC)

Złączka LED Lynx Z (12V DC) (24V DC)



Power/Moc	Input	Output	Finishing/Wykończenie	Packaging/Opakowanie	Cod.
48W/96W	12/24V DC	12/24V DC	Not defined/Nieokreślone	10 Unit/Szt	5208020

Plastic/Plastik

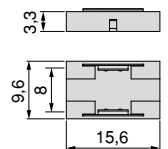

Lynx Z connectors are designed to join LED strips with a solid and resistant joint, thanks to their metal connectors. They are characterised by their small dimensions for joining LED strips with a width of 8 mm.

Złączki Lynx Z są przeznaczone do łączenia taśm LED z solidnym i wytrzymałym złączem, dzięki metalowym łącznikom. Charakteryzują się niewielkimi wymiarami do łączenia taśm LED o szerokości 8 mm.

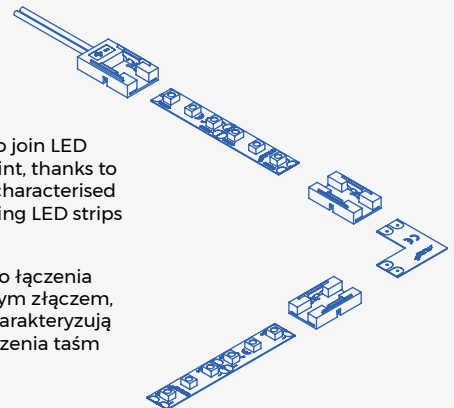

Lynx H cable LED (12V DC)
Kabel LED Lynx H (12V DC)

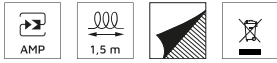

Power/Moc	Input	Output	Finishing/Wykończenie	Packaging/Opakowanie	Cod.
60W	12V DC	12V DC	Not defined/Nieokreślone	10 Unit/Szt	5061020

Plastic/Plastik

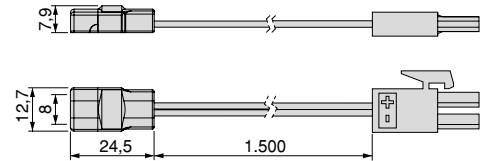

Lynx H connector LED (12V DC) (24V DC)
Złączka LED Lynx H (12V DC) (24V DC)



Power/Moc	Input	Output	Finishing/Wykończenie	Packaging/Opakowanie	Cod.
48W/96W	12/24V DC	12/24V DC	Not defined/Nieokreślone	10 Unit/Szt	5061120

Plastic/Plastik

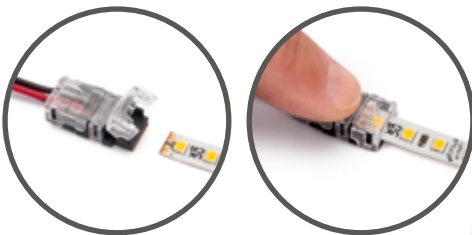
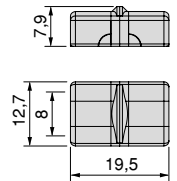

Lynx H connectors are designed to join LED strips with a solid and strong joint, ideal for use in conjunction with Lynx profiles. They also feature a transparent finish to minimise luminous flux reduction.

Złączki Lynx H są przeznaczone do łączenia taśm LED za pomocą solidnego i mocnego złącza, idealnego do stosowania w połączeniu z profilami Lynx. Posiadają również przezroczyste wykończenie, aby zminimalizować redukcję strumienia świetlnego.

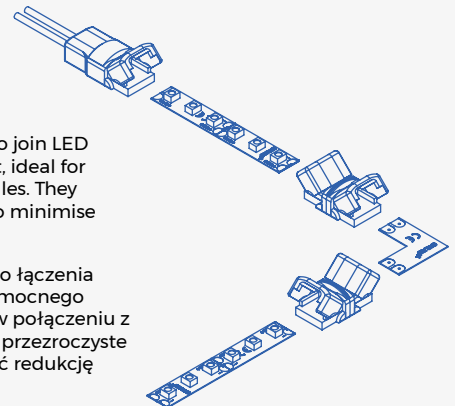

Lynx Q cable LED (12V DC)
Kabel LED Lynx Q (12V DC)

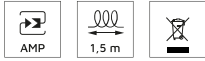

Power/Moc	Input	Output	Finishing/Wykończenie	Packaging/Opakowanie	Cod.
36W	12V DC	12V DC	Black plastic/Czarny plastik	10 Unit/Szt	7015417

Plastic/Plastik

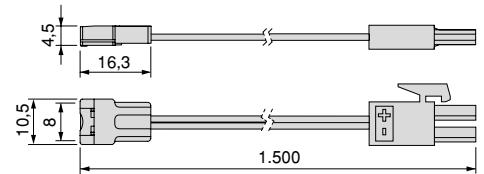

Lynx Q connector LED (12V DC)
Złącza LED Lynx Q (12V DC)



Power/Moc	Input	Output	Finishing/Wykończenie	Packaging/Opakowanie	Cod.
36W/72W	12/24V DC	12/24V DC	Not defined/Nieokreślone	10 Unit/Szt	7015520

Plastic/Plastik

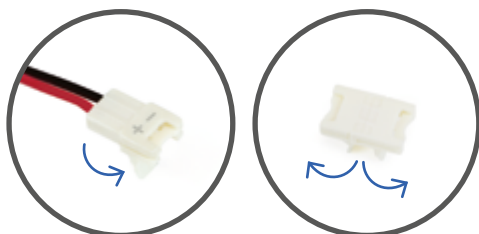
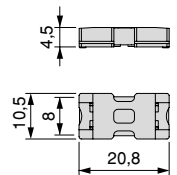
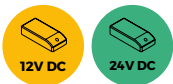

Lynx Q connectors feature a hinged cover at the bottom, which secures the LED strip, improving connectivity and preventing it from detaching easily, withstanding tensile forces of up to 2.5 kg.

Złącza Lynx Q mają zawiasową pokrywę na dole, która mocuje pasek LED, poprawiając łączność i zapobiegając jego łatwemu odłączeniu, wytrzymując siły rozciągające do 2,5 kg.

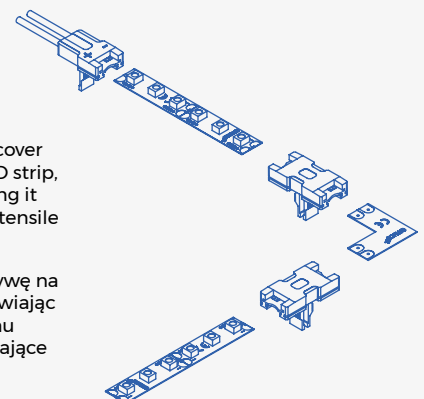

Lynx Q cable LED flexible (12V DC) (24V DC)

Złącza LED Lynx Q elastyczna (12V DC) (24V DC)



Power/Moc	Input	Output	Finishing/Wykończenie	Packaging/Opakowanie	Cod.
36W/72W	12/24V DC	12/24V DC	Not defined/Nieokreślone <input type="checkbox"/>	10 Unit/Szt	5203220

Plastic/Plastik

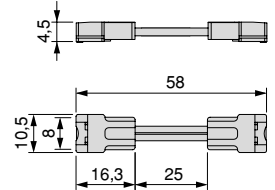
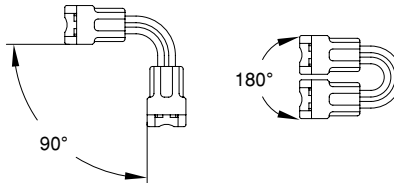
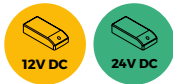

It has a cable between connectors that allows interconnections at angles from 0° to 180° in a flexible way.

Pomiędzy złączami znajduje się kabel, który umożliwia elastyczne połączenia pod kątem od 0° do 180°.

Lynx union L LED (12V DC) (24V DC)

Union L LED Lynx (12V DC) (24V DC)



Power/Moc	Input	Output	Finishing/Wykończenie	Packaging/Opakowanie	Cod.
48W/96W	12/24V DC	12/24V DC	Not defined/Nieokreślone <input type="checkbox"/>	10 Unit/Szt	5202820

Plastic/Plastik

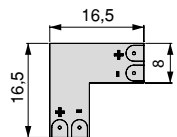
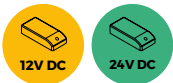

AMP extension cable (12V DC)

Przedłużacz AMP (12V DC)



Longitude/Długość	Power/Moc	Finishing/Wykończenie	Packaging/Opakowanie	Cod.
2 m	Max. 60 W	Black plastic/Czarny plastik <input checked="" type="checkbox"/>	25 Unit/Szt	9269817

Plastic/Plastik

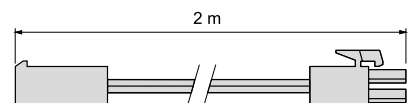

LED Strips Lynx Premium 24V DC

Taśma LED Premium Lynx 24V DC

Lynx Premium LED strip is suitable for long length installations, as it has good efficiency and high performance.

Taśma LED Lynx Premium nadaje się do instalacji o dużej długości, ponieważ ch

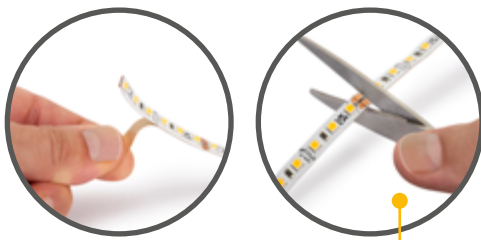

15W 5211220
30W 5147620
50W 5147720
100W 5209520

The 3M® 300LSE adhesive tape provides the best adhesion.
Taśma samoprzylepna 3M® 300LSE zapewnia najlepszą przyczepność.

LED Strip Lynx Premium 9,6 W/m IP20 (24V DC)

Taśma LED Lynx Premium 9,6 W/m IP20 (24V DC)

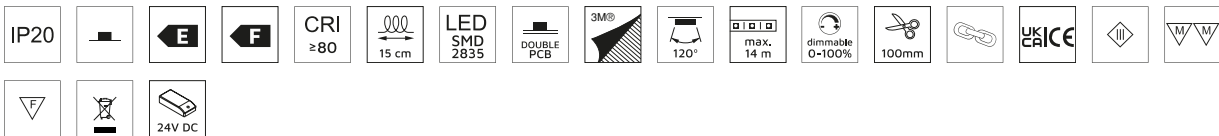

L	Efficiency/ Wydajność	Lumen	Power/Moc	Colour temperature/ Temperatura koloru	LEDs	Finishing/Wykończenie	Packaging/ Opakowanie	Cod.
10 m	E (1.142 lm / W)	119 lm / m	9,6 W / m	Natural white 4.000 K/ Naturalna biel 4.000 K	120 LEDs / m	Not defined/ Nieokreślone	1 Unit/Szt	5205320
10 m	F (1.046 lm / W)	109 lm / m	9,6 W / m	Warm white 2.700 K/ Ciepła biel 2.700 K	120 LEDs / m	Not defined/ Nieokreślone	1 Unit/Szt	5205420

Plastic/Plastik



Length	4.000 K	2.700 K
0,25 m	3.300 lx	3.201 lx
0,50 m	1.325 lx	1.285 lx
0,75 m	655 lx	635 lx
1,00 m	371 lx	360 lx
1,25 m	239 lx	232 lx

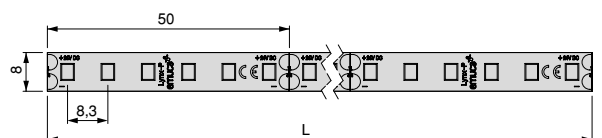

LED Strips Lynx Premium COB 24V DC

Taśma LED Lynx Premium COB 24V DC

The Lynx Premium COB LED strip is designed with a continuous line known as Chip On Board, which generates a uniform, dot-free LED light.

Taśma LED Lynx Premium COB została zaprojektowana z ciągłą linią znaną jako Chip On Board, która generuje jednolite, pozbawione kropek światło LED.

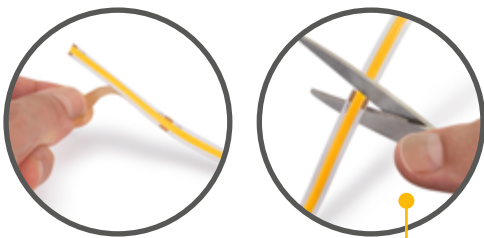

15W 5211220
30W 5147620
50W 5147720
100W 5209520

It stands out for its high luminance and continuity of light.
Wyróżnia się wysoką luminancją i ciągłością światła.



LED Strip Lynx Premium COB 9,6 W/m IP20 (24V DC)

Taśma LED Lynx Premium COB 9,6 W/m IP20 (24V DC)

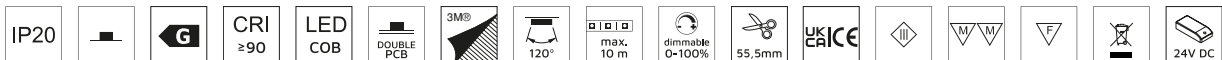

L	Efficiency/Wydajność	Lumen	Power/Moc	Colour temperature/ Temperatura koloru	LEDs	Finishing/Wykończenie	Packaging/ Opakowanie	Cod.
5 m	120 lm / W	1.152 lm / m	9,6 W / m	Cold white 6.000 K/ Zimna biel 6.000 K	480 LEDs / m	Not defined/ Nieokreślone	2 Unit/Szt	5216720
5 m	115 lm / W	1.112 lm / m	9,6 W / m	Natural white 4.000 K/ Naturalna biel 4.000 K	480 LEDs / m	Not defined/ Nieokreślone	2 Unit/Szt	5216820
5 m	105 lm / W	1.015 lm / m	9,6 W / m	Warm white 2.700 K/ Ciepła biel 2.700 K	480 LEDs / m	Not defined/ Nieokreślone	2 Unit/Szt	5216920

Plastic/Plastik



	6.000 K	4.000 K	2.700 K
0,25 m	1.900 lx	1.800 lx	1.740 lx
0,50 m	810 lx	760 lx	700 lx
0,75 m	450 lx	442 lx	372 lx
1,00 m	294 lx	276 lx	230 lx
1,25 m	214 lx	197 lx	161 lx

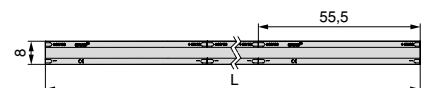

LED Strips Neonlynx 24V DC Taśma LED Neonlynx 24V DC

Neonlynx LED strips are designed to create curved shapes for maximum integration into the furniture.

Taśmy LED Neonlynx zostały zaprojektowane do tworzenia zakrzywionych kształtów w celu maksymalnej integracji z meblami.

4x11 Neonlynx V 24V DC

12x5 Neonlynx H 24V DC

6x6 Neonlynx H 24V DC

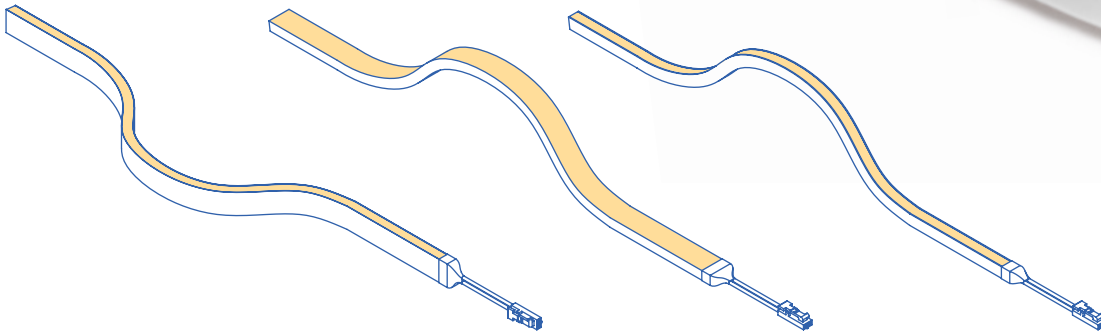

15W	5211220
30W	5147620
50W	5147720
100W	5209520

They are made of high quality silicone to avoid colour temperature variation and have an IP65 protection rating, suitable for installation in damp places.

Wykonane są z wysokiej jakości silikonu, aby uniknąć zmian temperatury barwowej i mają stopień ochrony IP65, odpowiedni do instalacji w wilgotnych miejscach.

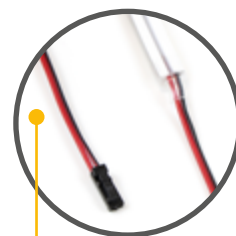

They have two 1.5 m power cables, one on each side of the LED strip, with miniled connector.

Posiadają dwa kable zasilające o długości 1,5 m, po jednym z każdej strony taśmy LED, ze złączem minilinii.

4x11 Neonlynx V 24V DC

The 4x11 Neonlynx V LED strip is designed to create curved or straight shapes in 4 mm wide by 11 mm deep recesses, achieving maximum integration into the furniture.

Taśma LED 4x11 Neonlynx V została zaprojektowana do tworzenia zakrzywionych lub prostych kształtów we wnękach o szerokości 4 mm i głębokości 11 mm, zapewniając maksymalną integrację z meblami.

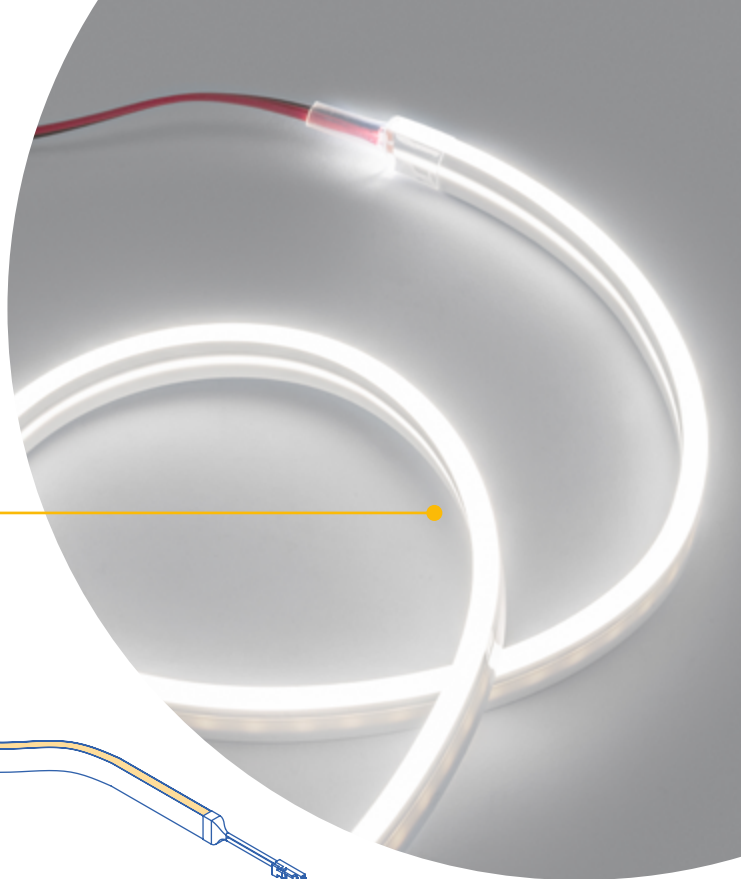

15W 5211220
30W 5147620
50W 5147720
100W 5209520

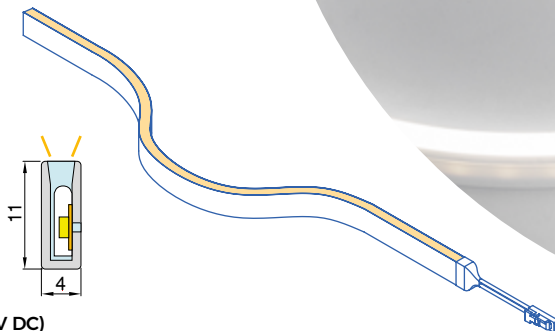

LED Strip 4x11 Neonlynx V, 7,6W/m IP65 (24V DC)
Taśma LED 4x11 Neonlynx V, 7,6W/m IP65 (24V DC)

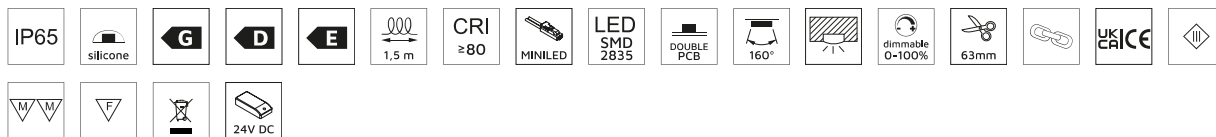

L	Efficiency/ Wydajność	Lumen	Power/Moc	Colour temperature/ Temperatura koloru	LEDs	Finishing/Wykończenie	Packaging/ Opakowanie	Cod.
1.008 mm	G (42 lm / W)	316 lm / m	7,6 W / m	Cold white 6.000 K/ Zimna biel 6.000 K	128 LEDs / m	Not defined/ Nieokreślone	8 Unit/Szt	5206320
3.024 mm	G (42 lm / W)	316 lm / m	7,6 W / m	Cold white 6.000 K/ Zimna biel 6.000 K	128 LEDs / m	Not defined/ Nieokreślone	2 Unit/Szt	5206420
5.040 mm	G (42 lm / W)	316 lm / m	7,6 W / m	Cold white 6.000 K/ Zimna biel 6.000 K	128 LEDs / m	Not defined/ Nieokreślone	2 Unit/Szt	5206520
1.008 mm	D (49 lm / W)	375 lm / m	7,6 W / m	Natural white 4.000 K/ Naturalna biel 4.000 K	128 LEDs / m	Not defined/ Nieokreślone	8 Unit/Szt	5204220
3.024 mm	D (49 lm / W)	375 lm / m	7,6 W / m	Natural white 4.000 K/ Naturalna biel 4.000 K	128 LEDs / m	Not defined/ Nieokreślone	2 Unit/Szt	5204320
5.040 mm	D (49 lm / W)	375 lm / m	7,6 W / m	Natural white 4.000 K/ Naturalna biel 4.000 K	128 LEDs / m	Not defined/ Nieokreślone	2 Unit/Szt	5204420
1.008 mm	E (49 lm / W)	370 lm / m	7,6 W / m	Warm white 2.700 K/ Ciepła biel 2.700 K	128 LEDs / m	Not defined/ Nieokreślone	8 Unit/Szt	5206020
3.024 mm	E (49 lm / W)	370 lm / m	7,6 W / m	Warm white 2.700 K/ Ciepła biel 2.700 K	128 LEDs / m	Not defined/ Nieokreślone	2 Unit/Szt	5206120
5.040 mm	E (49 lm / W)	370 lm / m	7,6 W / m	Warm white 2.700 K/ Ciepła biel 2.700 K	128 LEDs / m	Not defined/ Nieokreślone	2 Unit/Szt	5206220

Plastic/Plastik

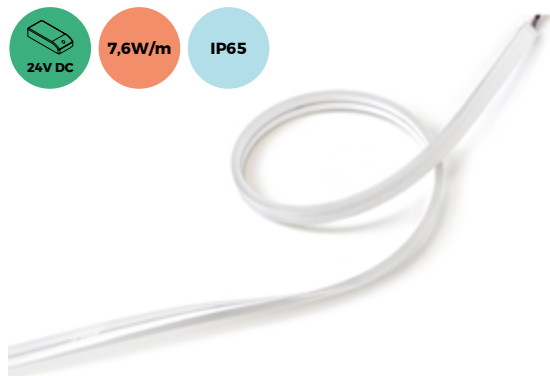

	6.000 K	4.000 K	2.700 K
0,25 m	1.011 lx	1.075 lx	1.043 lx
0,50 m	439 lx	467 lx	453 lx
0,75 m	247 lx	263 lx	255 lx
1,00 m	151 lx	160 lx	155 lx
1,25 m	100 lx	106 lx	103 lx

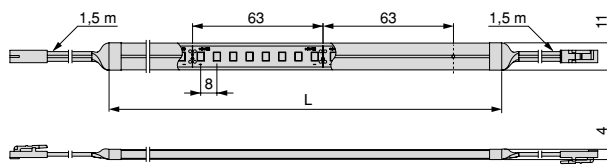

12x5 Neonlynx H 24V DC

The 12x5 Neonlynx H LED strip has a reduced height with superior illumination, which allows it to be used on the surface of the furniture and to be bent to make curves.

Taśma LED Neonlynx H 12x5 ma zmniejszoną wysokość i doskonałe oświetlenie, co pozwala na stosowanie jej na powierzchni mebli i wyginanie w celu uzyskania krzywizn.

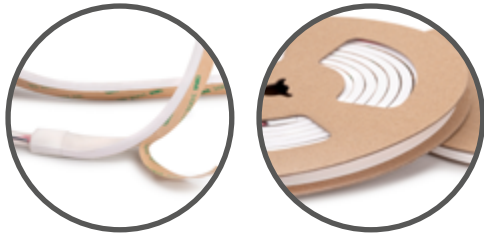

24V DC

15W	5211220
30W	5147620
50W	5147720
100W	5209520

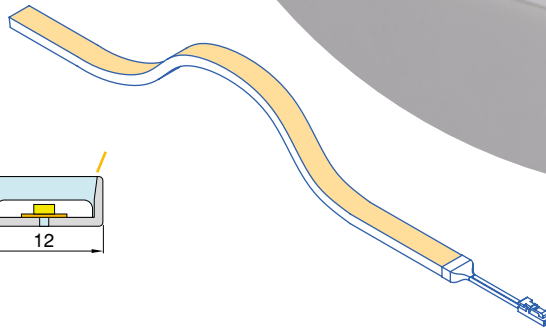
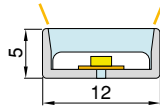

LED Strip 12x5 Neonlynx H, 7,6W/m IP65 (24V DC)

Taśma LED 12x5 Neonlynx H, 7,6W/m IP65 (24V DC)

L	Efficiency/ Wydajność	Lumen	Power/Moc	Colour temperature/ Temperatura koloru	LEDs	Finishing/Wykończenie	Packaging/ Opakowanie	Cod.
1.000 mm	E (129 lm / W)	983 lm / m	7,6 W / m	Natural white 4.000 K/ Naturalna biel 4.000 K	240 LEDs / m	Not defined/ Nieokreślone	8 Unit/Szt	5217720
3.000 mm	E (129 lm / W)	983 lm / m	7,6 W / m	Natural white 4.000 K/ Naturalna biel 4.000 K	240 LEDs / m	Not defined/ Nieokreślone	2 Unit/Szt	5217820
5.000 mm	E (129 lm / W)	983 lm / m	7,6 W / m	Natural white 4.000 K/ Naturalna biel 4.000 K	240 LEDs / m	Not defined/ Nieokreślone	2 Unit/Szt	5217920
1.000 mm	F (125 lm / W)	953 lm / m	7,6 W / m	Warm white 2.700 K/ Ciepła biel 2.700 K	240 LEDs / m	Not defined/ Nieokreślone	8 Unit/Szt	5219420
3.000 mm	F (125 lm / W)	953 lm / m	7,6 W / m	Warm white 2.700 K/ Ciepła biel 2.700 K	240 LEDs / m	Not defined/ Nieokreślone	2 Unit/Szt	5219520
5.000 mm	F (125 lm / W)	953 lm / m	7,6 W / m	Warm white 2.700 K/ Ciepła biel 2.700 K	240 LEDs / m	Not defined/ Nieokreślone	2 Unit/Szt	5219620

Plastic/Plastik

24V DC **7,6W/m** **IP65**

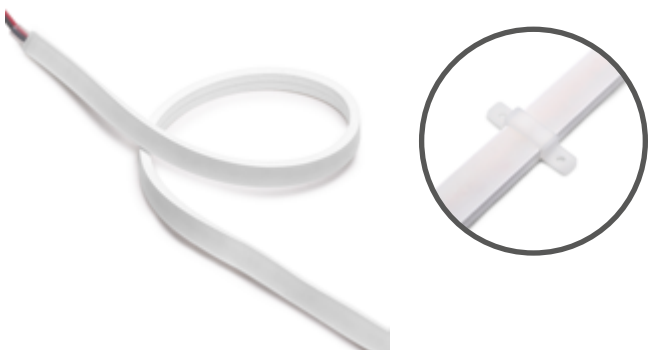

Distance	4.000 K	2.700 K
0,25 m	2.820 lx	2.735 lx
0,50 m	1.280 lx	1.242 lx
0,75 m	770 lx	747 lx
1,00 m	494 lx	479 lx
1,25 m	346 lx	336 lx

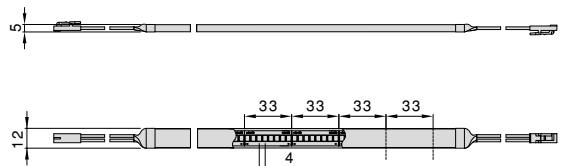

6x6 Neonlynx H 24V DC

The 6x6 Neonlynx H LED strip is designed for curved or straight shapes in recesses 6 mm wide by 6 mm deep, achieving maximum integration into the furniture.

Taśma LED Neonlynx H 6x6 jest przeznaczona do zakrzywionych lub prostych kształtów we wnękach o szerokości 6 mm i głębokości 6 mm, zapewniając maksymalną integrację z meblami.

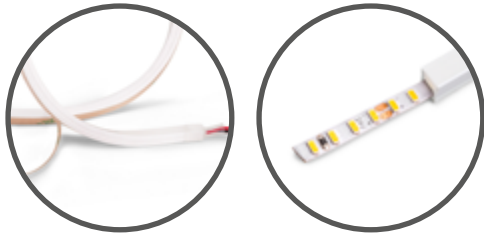

24V DC

15W	5211220
30W	5147620
50W	5147720
100W	5209520

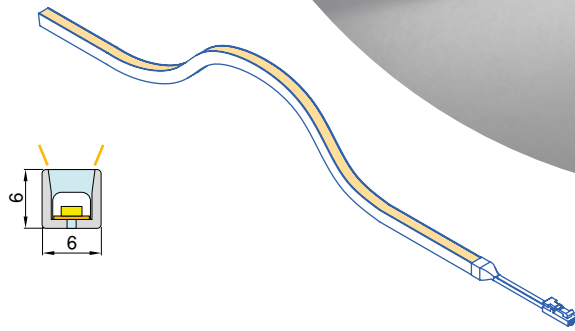

LED Strip 6x6 Neonlynx H, 7,6W/m IP65 (24V DC)

Taśma LED 6x6 Neonlynx H, 7,6W/m IP65 (24V DC)

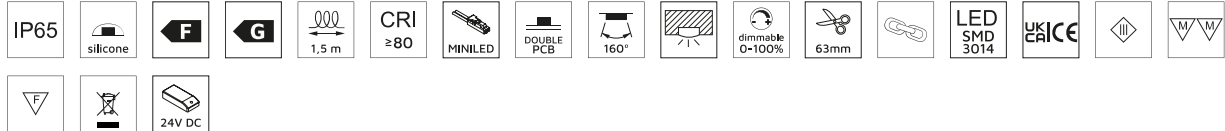

L	Efficiency/ Wydajność	Lumen	Power/Moc	Colour temperature/ Temperatura koloru	LEDs	Finishing/Wykończenie	Packaging/ Opakowanie	Cod.
1.008 mm	G (87 lm / W)	632 lm / m	7.2 W / m	Natural white 4.000 K/ Naturalna biel 4.000 K	210 LEDs / m	Not defined/ Nieokreślone	8 Unit/Szt	5219720
3.024 mm	G (87 lm / W)	632 lm / m	7.2 W / m	Natural white 4.000 K/ Naturalna biel 4.000 K	210 LEDs / m	Not defined/ Nieokreślone	2 Unit/Szt	5219820
5.040 mm	G (87 lm / W)	632 lm / m	7.2 W / m	Natural white 4.000 K/ Naturalna biel 4.000 K	210 LEDs / m	Not defined/ Nieokreślone	2 Unit/Szt	5219920
1.008 mm	F (90 lm / W)	652 lm / m	7.2 W / m	Warm white 2.700 K/ Ciepła biel 2.700 K	240 LEDs / m	Not defined/ Nieokreślone	8 Unit/Szt	5220120
3.024 mm	F (90 lm / W)	652 lm / m	7.2 W / m	Warm white 2.700 K/ Ciepła biel 2.700 K	210 LEDs / m	Not defined/ Nieokreślone	2 Unit/Szt	5220220
5.040 mm	F (90 lm / W)	652 lm / m	7.2 W / m	Warm white 2.700 K/ Ciepła biel 2.700 K	210 LEDs / m	Not defined/ Nieokreślone	2 Unit/Szt	5220320

Plastic/Plastik

24V DC **7,6W/m** **IP65**

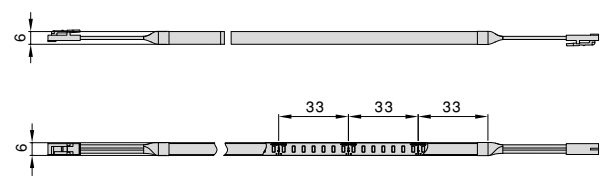
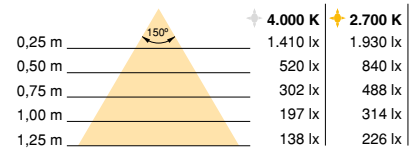

Lynx Z cable LED (24V DC)

Kabel LED Lynx Z (24V DC)



Power/Moc	Input	Output	Finishing/Wykończenie	Packaging/Opakowanie	Cod.
72W	24V DC	24V DC	Not defined/Nieokreślone	10 Unit/Szt	5207920

Plastic/Plastik

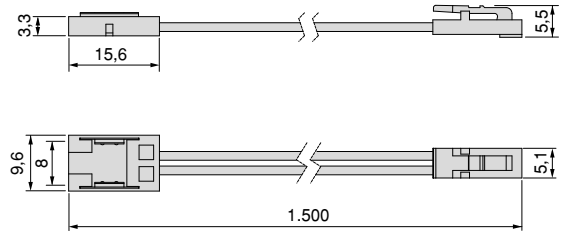

Lynx Z connector LED (12V DC) (24V DC)

Złączka LED Lynx Z (12V DC) (24V DC)



Power/Moc	Input	Output	Finishing/Wykończenie	Packaging/Opakowanie	Cod.
48W/96W	12/24V DC	12/24V DC	Not defined/Nieokreślone	10 Unit/Szt	5208020

Plastic/Plastik

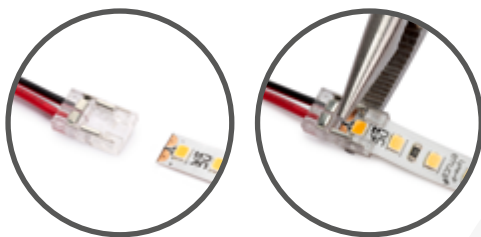
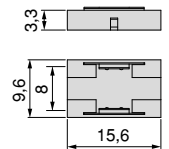

Lynx Z connectors are designed to join LED strips with a solid and resistant joint, thanks to their metal connectors. They are characterised by their small dimensions for joining LED strips with a width of 8 mm.

Złączki Lynx Z są przeznaczone do łączenia taśm LED z solidnym i wytrzymałym złączem, dzięki metalowym łącznikom. Charakteryzują się niewielkimi wymiarami do łączenia taśm LED o szerokości 8 mm.

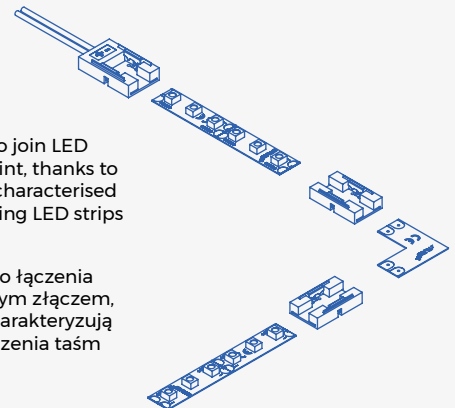

Lynx H cable LED (24V DC)

Kabel LED Lynx H (24V DC)



Power/Moc	Input	Output	Finishing/Wykończenie	Packaging/Opakowanie	Cod.
72W	24V DC	24V DC	Not defined/Nieokreślone <input type="checkbox"/>	10 Unit/Szt	5204820

Plastic/Plastik

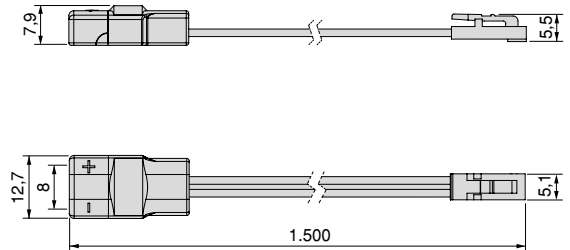

Lynx H connector LED (12V DC) (24V DC)

Złączka LED Lynx H (12V DC) (24V DC)



Power/Moc	Input	Output	Finishing/Wykończenie	Packaging/Opakowanie	Cod.
48W/96W	12/24V DC	12/24V DC	Not defined/Nieokreślone <input type="checkbox"/>	10 Unit/Szt	5061120

Plastic/Plastik

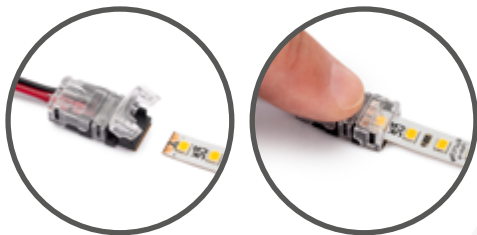
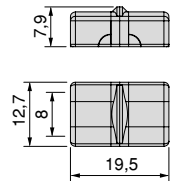
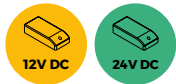

Lynx H connectors are designed to join LED strips with a solid and strong joint, ideal for use in conjunction with Lynx profiles. They also feature a transparent finish to minimise luminous flux reduction.

Złączki Lynx H zostały zaprojektowane do łączenia taśm LED za pomocą solidnego i wytrzymałego złącza, idealnego do stosowania w połączeniu z profilami Lynx. Posiadają również przezroczyste wykończenie, aby zminimalizować redukcję strumienia świetlnego.

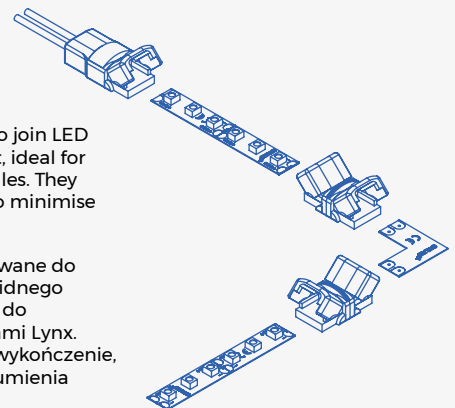

Lynx Q kabel LED (24V DC)

Kabel LED Lynx Q (24V DC)



Power/Moc	Input	Finishing/Wykończenie	Packaging/Opakowanie	Cod.
72W	24V DC	Not defined/Nieokreślone	<input type="checkbox"/> 10 Unit/Szt	5221820

Plastic/Plastik

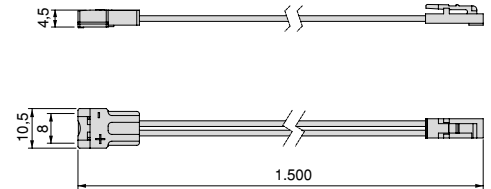

Lynx Q connector LED (12V DC)

Złącza LED Lynx Q (12V DC)



Power/Moc	Input	Output	Finishing/Wykończenie	Packaging/Opakowanie	Cod.
36W/72W	12/24V DC	12/24V DC	Not defined/Nieokreślone	<input type="checkbox"/> 10 Unit/Szt	7015520

Plastic/Plastik

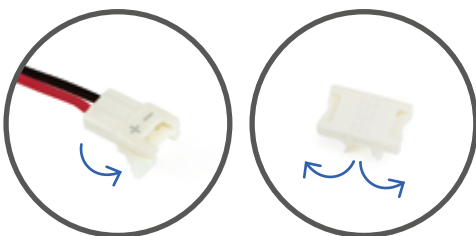
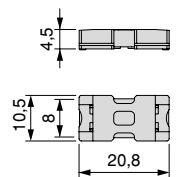
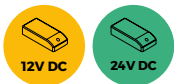

Lynx Q connectors have a hinged cover at the bottom, which fixes the LED strip, improving connectivity and preventing it from detaching easily, withstanding tensile forces of up to 2.5 kg.

Złącza Lynx Q mają zawiasową pokrywę na dole, która mocuje pasek LED, poprawiając łączność i zapobiegając jego łatwemu odłączeniu, wytrzymując siły rozciągające do 2,5 kg.

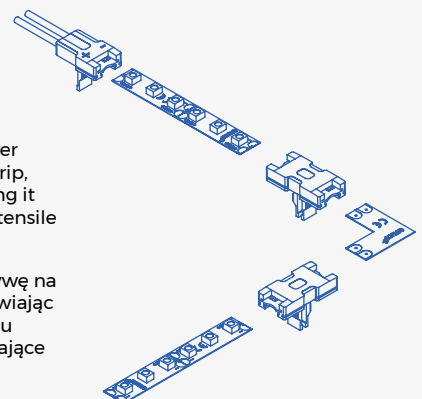

Lynx Q cable LED flexible (12V DC) (24V DC)

Złącza LED Lynx Q elastyczna (12V DC) (24V DC)



Power/Moc	Input	Output	Finishing/Wykończenie	Packaging/Opakowanie	Cod.
36W/72W	12/24V DC	12/24V DC	Not defined/Nieokreślone <input type="checkbox"/>	10 Unit/Szt	5203220

Plastic/Plastik

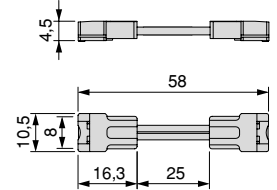
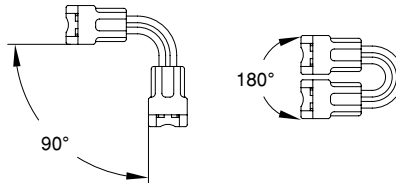
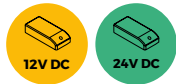

It has a cable between connectors that allows interconnections at angles from 0° to 180° in a flexible way.

Pomiędzy złączami znajduje się kabel, który umożliwia elastyczne połączenia pod kątem od 0° do 180°.

Lynx union L LED (12V DC) (24V DC)

Union L LED Lynx (12V DC) (24V DC)



Power/Moc	Input	Output	Finishing/Wykończenie	Packaging/Opakowanie	Cod.
48W/96W	12/24V DC	12/24V DC	Not defined/Nieokreślone <input type="checkbox"/>	10 Unit/Szt	5202820

Plastic/Plastik

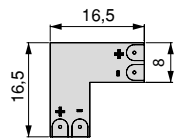
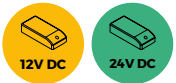

Miniled cable extension (24V DC)

Przedłużacz MiniLED (24 V DC)

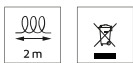

Power/Moc	Input	Output	Finishing/Wykończenie	Packaging/Opakowanie	Cod.
72W	24V DC	24V DC	Not defined/Nieokreślone <input type="checkbox"/>	25 Unit/Szt	5204920

Plastic/Plastik



It can be used to extend 2 metres if the distance between the converter and the luminaire is very long.

Można go użyć do przedłużenia o 2 metry, jeśli odległość między konwerterem a oprawą oświetleniową jest bardzo duża.

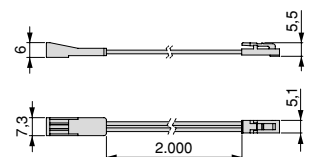

Sensors Lynx Czujniki Lynx

Lynx Z sensors add functionality to your LED strip installations as a switch or detector.

Czujniki Lynx Z zwiększają funkcjonalność instalacji taśm LED jako przełącznik lub detektor.

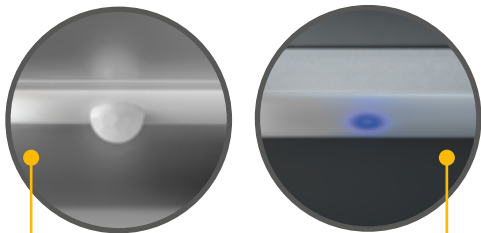

The sensor switches the luminaire on when the user interferes with its detection range, and switches itself off after 30 seconds.

Czujnik włącza oprawę oświetleniową, gdy użytkownik wejdzie w zasięg jego wykrywania, i wyłącza się po 30 sekundach.



The sensor switches the luminaire on or off with a short press, and increases or reduces the luminous flux with a long press.

Czujnik włącza lub wyłącza oprawę za pomocą krótkiego naciśnięcia, a zwiększa lub zmniejsza strumień świetlny za pomocą długiego naciśnięcia.

They have a built-in connector that allows a quick, easy and secure connection.

Posiadają wbudowane złącze do szybkiego, łatwego i bezpiecznego podłączenia.



They are characterised by their small dimensions for connecting 8 mm wide LED strips, ideal for use in conjunction with Lynx W profiles.

Charakteryzują się niewielkimi wymiarami do podłączania taśm LED o szerokości 8 mm, idealne do stosowania w połączeniu z profilami Lynx W.

Sensor for LED strip Lynx Z Motion (12V DC) (24V DC)

Lynx Z Motion (12V DC) (24V DC) czujnik do taśm LED

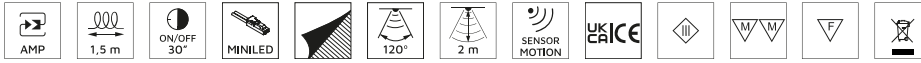

Model/Model	Power/Moc	Input	Output	Finishing/Wykończenie	Packaging/Opakowanie	Cod.
MOTION/	36W/72W	12/24V DC	12/24V DC	Not defined/ Nieokreślone	<input type="checkbox"/>	10 Unit/Szt 5208220

Plastic/Plastik

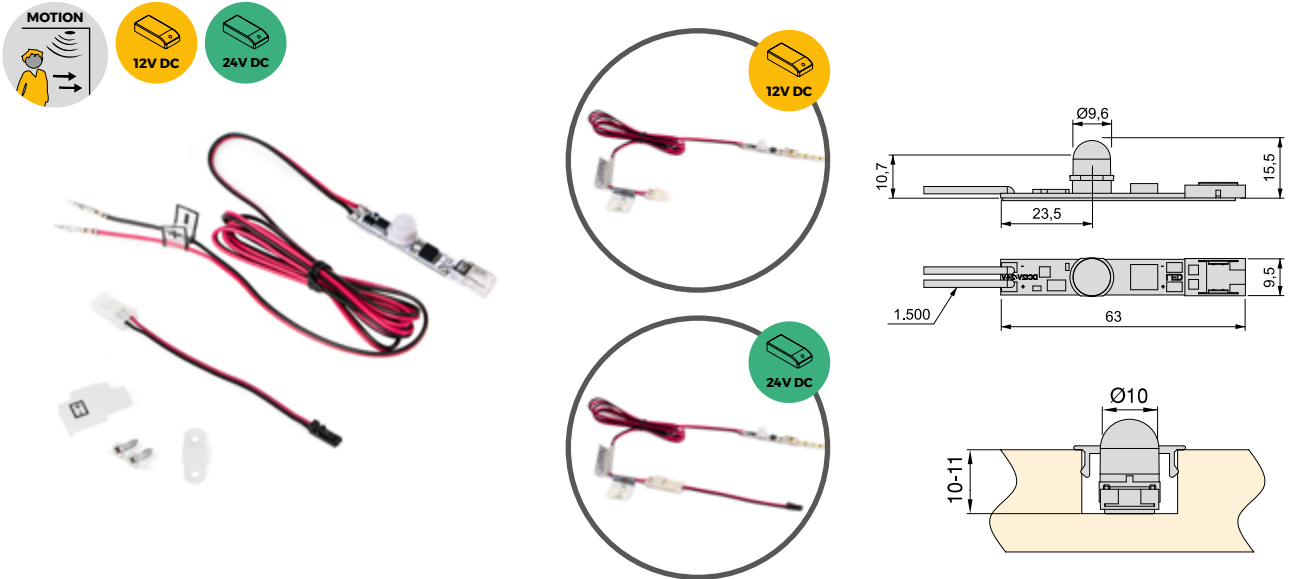

Sensor for LED strip Lynx Z Touch Dimmer (12V DC) (24V DC)

Lynx Z Touch Dimmer (12V DC) (24V DC) czujnik do taśm LED



Model/Model	Power/Moc	Input	Output	Finishing/Wykończenie	Packaging/Opakowanie	Cod.
TOUCH / DIMMER/ TOUCH / DIMMER	36W/72W	12/24V DC	12/24V DC	Not defined/ Nieokreślone	<input type="checkbox"/>	10 Unit/Szt 5208120

Plastic/Plastik

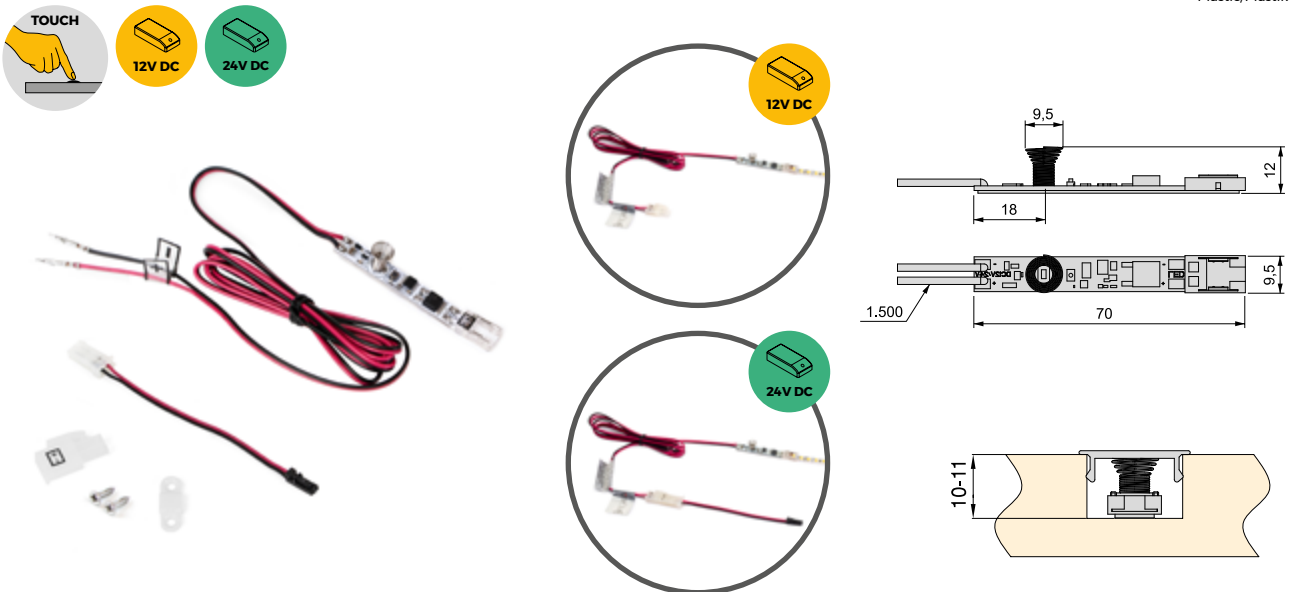

Profiles Lynx Profile Lynx

Lynx profiles are designed to create luminaires integrated in the furniture with Lynx LED strips. They are the best solution for easy lighting installations with aluminium profiles.

Profile Lynx są przeznaczone do tworzenia opraw oświetleniowych zintegrowanych z meblami za pomocą taśm LED Lynx. Są one najlepszym rozwiązaniem dla łatwych instalacji oświetleniowych z profilami aluminiowymi.



PROFILES LYNX W / PROFILE LYNX WW



PROFILES LYNX W / PROFILE LYNX W

FLAT / PŁASKI

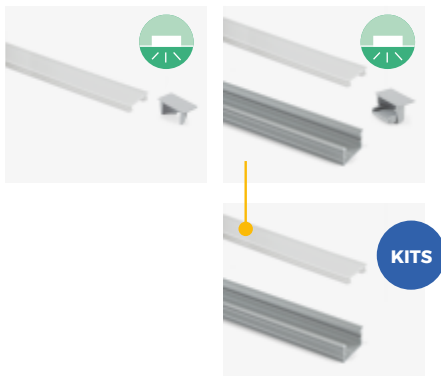

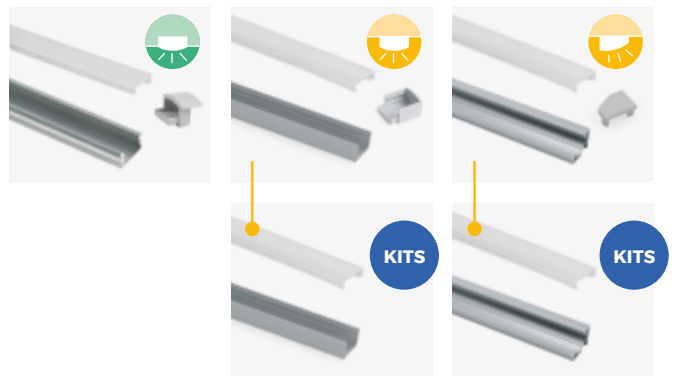

CURVED / ZAKRZYWIONY



Lynx W diffuser profile for LED strip
 Profil rozpraszający Lynx W do taśmy LED



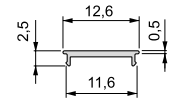
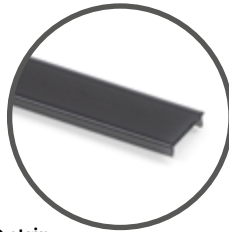

Longitude/Długość	Finishing/Wykończenie	Packaging/Opakowanie	Cod.
2,35 m	White plastic/Biały plastik 	20 Unit/Szt	5147815
2,35 m	Black plastic/Czarny plastik 	20 Unit/Szt	5147817

Plastic/Plastik



Profile Lynx W for recessed installation for LED strip
 Profil Lynx W do montażu wpuszczanego na taśmę LED



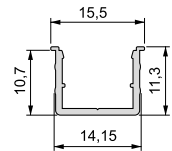
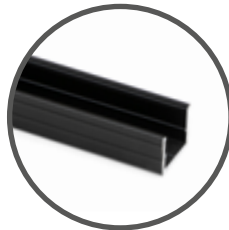
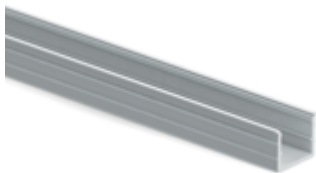

Longitude/Długość	Finishing/Wykończenie	Packaging/Opakowanie	Cod.
2,35 m	Matt anodized/Anodyzowany mat 	20 Unit/Szt	5147962
2,35 m	Black anodized/Czarny anodowany 	20 Unit/Szt	5147967

Aluminium/Aluminium



Accessory for recessed installation in aluminum Lynx W profile
 Akcesoria do montażu wpuszczanego w profilu aluminiowym Lynx W.



Finishing/Wykończenie	Packaging/Opakowanie	Cod.
Grey plastic/Szary plastik 	20 Unit/Szt	5148421
Black plastic/Czarny plastik 	20 Unit/Szt	5148417

Plastic/Plastik

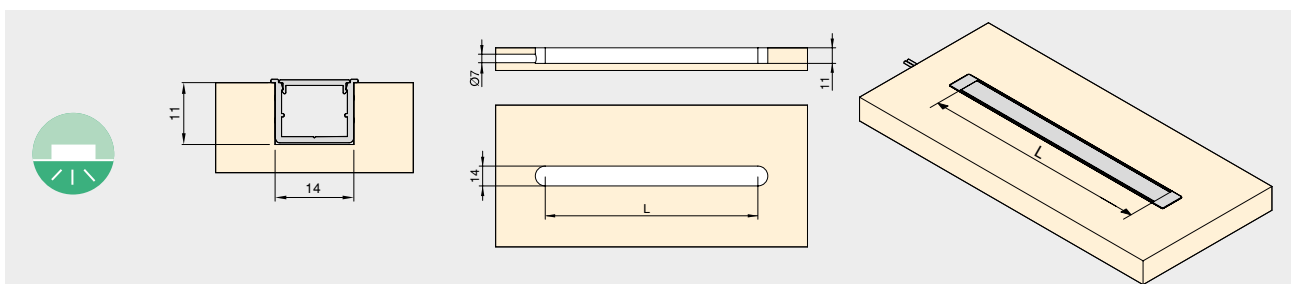
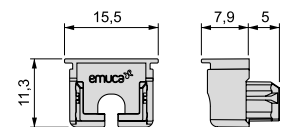

Lynx W diffuser profile for LED strip
 Profil rozpraszający Lynx W do taśmy LED



Longitude/Długość	Finishing/Wykończenie	Packaging/Opakowanie	Cod.
2,35 m	White plastic/Biały plastik	20 Unit/Szt	5147815
2,35 m	Black plastic/Czarny plastik	20 Unit/Szt	5147817

Plastic/Plastik

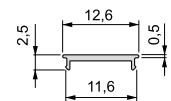
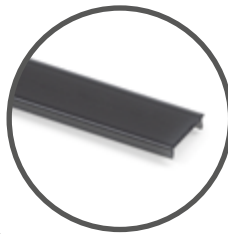

Surfacemount Lynx W profile for LED strip
 Profil Surfacemount Lynx W do taśmy LED



Longitude/Długość	Finishing/Wykończenie	Packaging/Opakowanie	Cod.
2,35 m	Matt anodized/Anodyzowany mat	20 Unit/Szt	5148062
2,35 m	Black anodized/Czarny anodowany	20 Unit/Szt	5148067

Aluminium/Aluminium

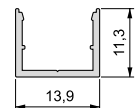
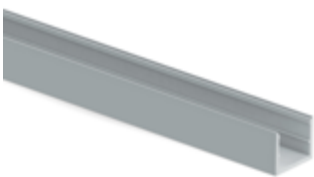

Accessories for surfacemount Lynx W profile
 Akcesoria do profilu powierzchniowego Lynx W.



Finishing/Wykończenie	Packaging/Opakowanie	Cod.
Grey plastic/Szary plastik	10 Unit/Szt	5148521
Black plastic/Czarny plastik	10 Unit/Szt	5148517

Plastic/Plastik

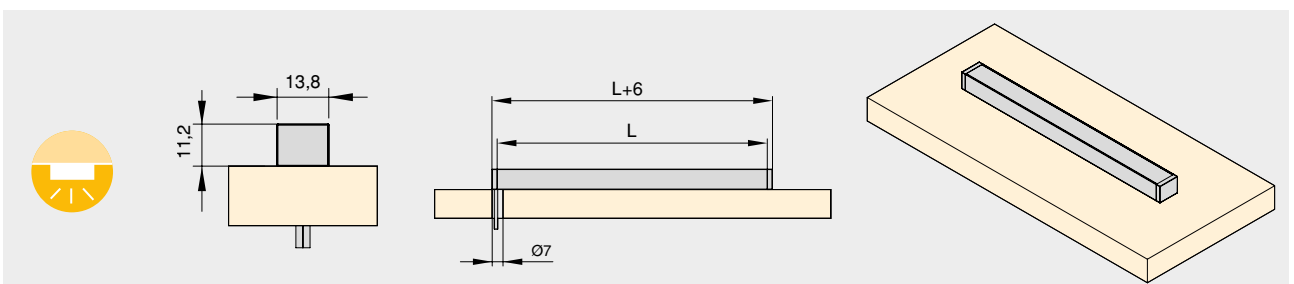
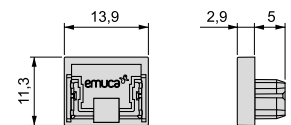
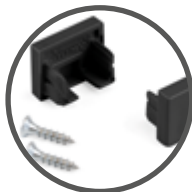

Profiles Lynx W for recessed installation for LED strip
 Profile Lynx W do montażu podtynkowego do taśm LED



Longitude/Długość	Finishing/Wykończenie		Packaging/Opakowanie	Cod.
2,35 m	Matt anodized/Anodyzowany mat		8 Unit/Szt	5148962
2,35 m	Black anodized/Czarny anodowany		8 Unit/Szt	5148967

Aluminium/Aluminium

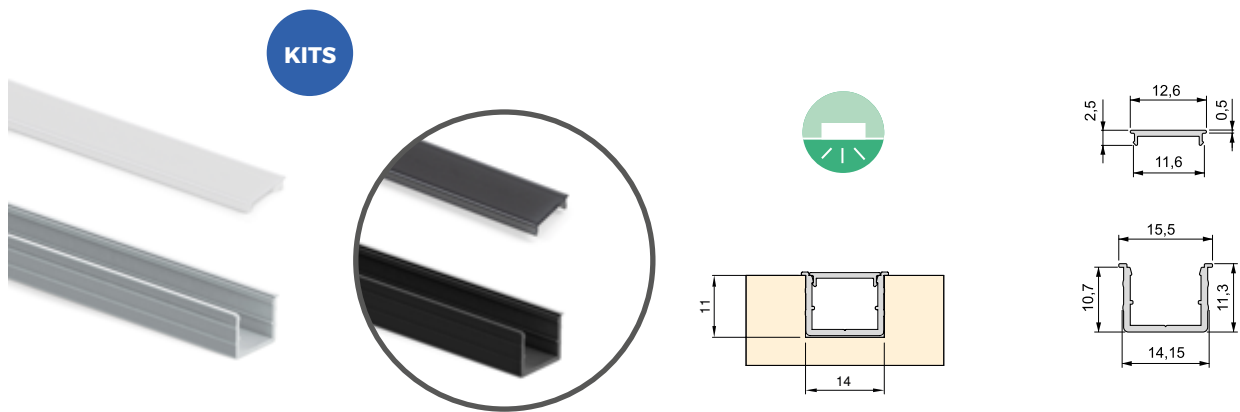

KITS

Surfacemount Lynx W profiles for LED strip
 Profile Surfacemount Lynx W do taśm LED



Longitude/Długość	Finishing/Wykończenie		Packaging/Opakowanie	Cod.
2,35 m	Matt anodized/Anodyzowany mat		8 Unit/Szt	5149062
2,35 m	Black anodized/Czarny anodowany		8 Unit/Szt	5149067

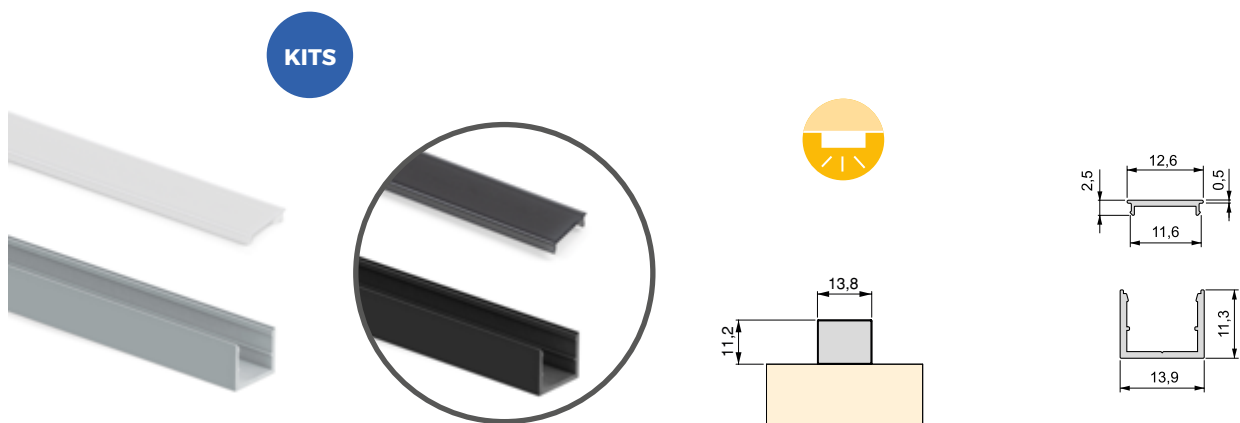

Aluminium/Aluminium



KITS

Flat diffuser profile for LED strip
 Płaski profil dyfuzora do taśm LED



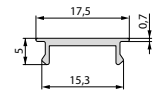

Longitude/Długość	Finishing/Wykończenie	Packaging/Opakowanie	Cod.
2,35 m	White plastic/Biały plastik 	20 Unit/Szt	5147115
3,9 m	White plastic/Biały plastik 	20 Unit/Szt	5146415

Plastic/Plastik



Flat profile for recessed installation for LED strip
 Płaski profil do osadzania do taśm LED



Longitude/Długość	Finishing/Wykończenie	Packaging/Opakowanie	Cod.
2,35 m	Matt anodized/Anodowany mat 	20 Unit/Szt	5085262
3,9 m	Matt anodized/Anodowany mat 	20 Unit/Szt	5146762

Aluminium/Aluminium

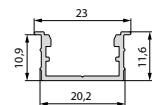
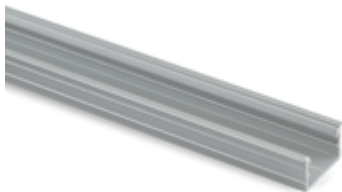

Accessory for recessed installation in aluminum profile the flat diffuser profile
 Akcesoria do montażu wpuszczanego w profilu aluminiowym - płaski profil nawiewnika



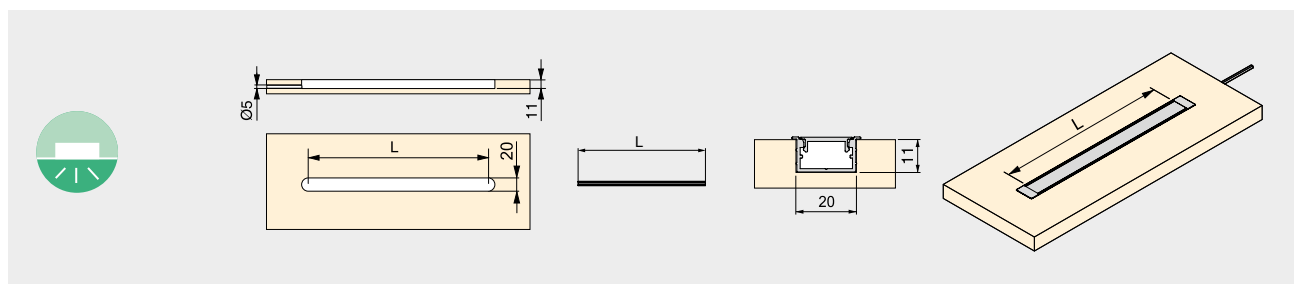
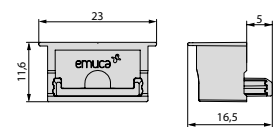

Finishing/Wykończenie	Packaging/Opakowanie	Cod.
Grey plastic/Szary plastik 	20 Unit/Szt	5146921

Plastic/Plastik



Curved diffuser profile for LED strip
 Zakrzywiony profil dyfuzora do taśm LED



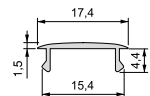

Longitude/Długość	Finishing/Wykończenie	Packaging/Opakowanie	Cod.
2,35 m	White plastic/Biały plastik 	20 Unit/Szt	5147015
2,9 m	White plastic/Biały plastik 	20 Unit/Szt	5147215

Plastic/Plastik



Profile for recessed installation for LED strip
 Profil do osadzenia do taśm LED



Longitude/Długość	Finishing/Wykończenie	Packaging/Opakowanie	Cod.
2,35 m	Matt anodized/Anodizowany mat 	20 Unit/Szt	5085162
2,9 m	Matt anodized/Anodizowany mat 	20 Unit/Szt	5085462

Aluminium/Aluminium

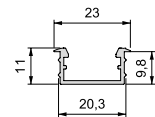

Accessory for recessed installation in aluminum profile the curved diffuser profile
 Akcesoria do montażu wpuszczanego w profilu aluminiowym zakrzywiony profil nawiewnika



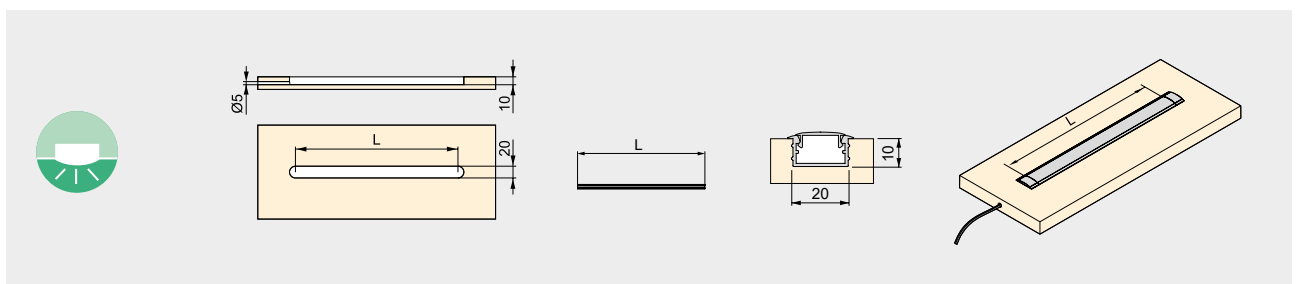
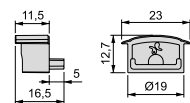

Finishing/Wykończenie	Packaging/Opakowanie	Cod.
Grey plastic/Szary plastik 	20 Unit/Szt	5144221

Plastic/Plastik



Curved diffuser profile for LED strip
 Zakrzywiony profil dyfuzora do taśm LED



Longitude/Długość	Finishing/Wykończenie	Packaging/Opakowanie	Cod.
2,35 m	White plastic/Biały plastik 	20 Unit/Szt	5147015
2,9 m	White plastic/Biały plastik 	20 Unit/Szt	5147215

Plastic/Plastik

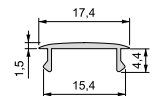

Surfacemount profile for LED strip
 Profil do powierzchni do taśm LED



Longitude/Długość	Finishing/Wykończenie	Packaging/Opakowanie	Cod.
2,35 m	Matt anodized/Anodyzowany mat 	20 Unit/Szt	5085062

Aluminium/Aluminium

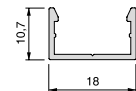
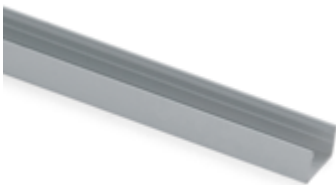

Accessories for surfacemount profile
 Akcesoria do profilu do montażu powierzchniowego



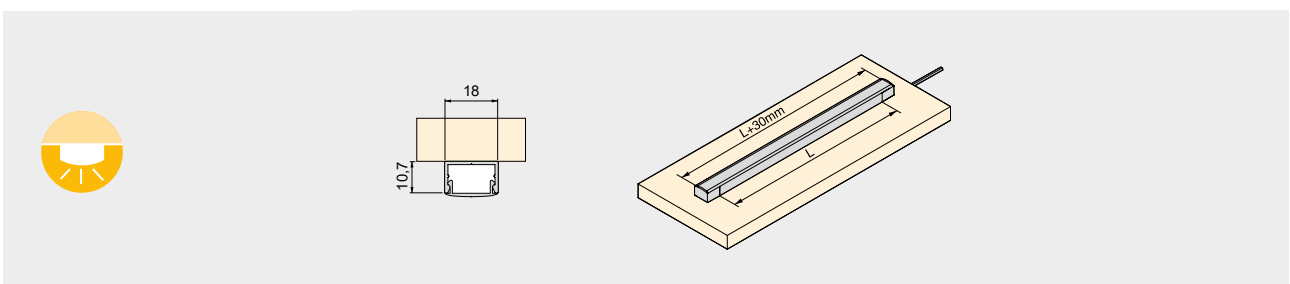
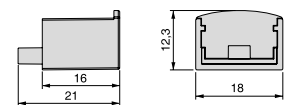

Finishing/Wykończenie	Packaging/Opakowanie	Cod.
Grey plastic/Szary plastik 	10 Unit/Szt	5143421

Plastic/Plastik



Curved diffuser profile for LED strip
 Zakrzywiony profil dyfuzora do taśm LED



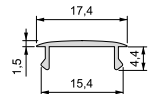

Longitude/Długość	Finishing/Wykończenie	Packaging/Opakowanie	Cod.
2,35 m	White plastic/Biały plastik 	20 Unit/Szt	5147015
2,9 m	White plastic/Biały plastik 	20 Unit/Szt	5147215

Plastic/Plastik



Profile for inclined surface for LED strip
 Nachylony profil do powierzchni do taśm LED



Longitude/Długość	Finishing/Wykończenie	Packaging/Opakowanie	Cod.
2,35 m	Matt anodized/Anodyzowany mat 	20 Unit/Szt	5085362
2,9 m	Matt anodized/Anodyzowany mat 	20 Unit/Szt	5085662

Aluminium/Aluminium

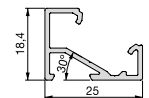

Accessories for inclined surface profile
 Akcesoria do nachylonych profili powierzchniowych



Finishing/Wykończenie	Packaging/Opakowanie	Cod.
Grey plastic/Szary plastik 	10 Unit/Szt	5146321

Plastic/Plastik

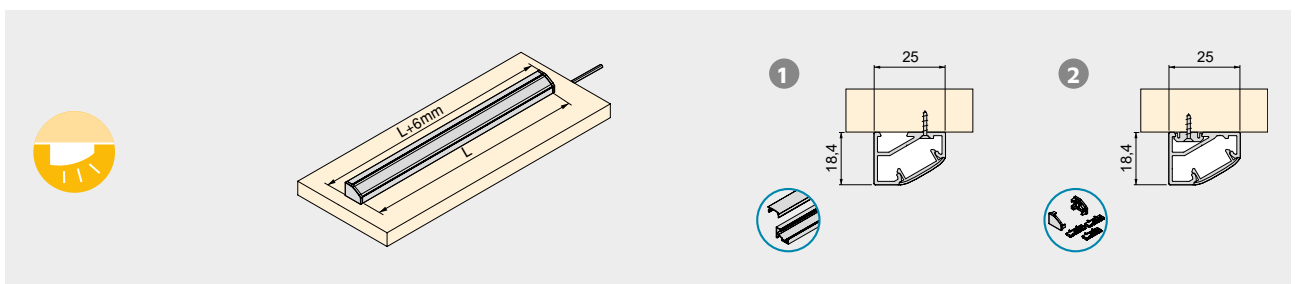
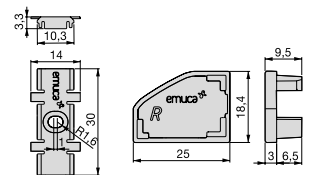

Profiles Lynx for recessed installation for LED strip
 Profile Lynx for recessed installation do taśm LED



Longitude/Długość	Finishing/Wykończenie	Packaging/Opakowanie	Cod.
2,35 m	Matt anodized/Anodyzowany mat	8 Unit/Szt	5148662

Aluminium/Aluminium

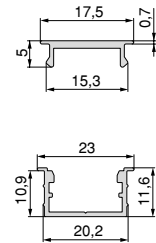
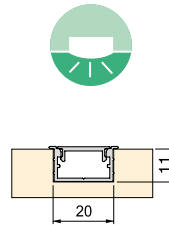

Surfacemount Lynx profiles for LED strip
 Surfacemount Lynx profile do taśm LED



Longitude/Długość	Finishing/Wykończenie	Packaging/Opakowanie	Cod.
2,35 m	Matt anodized/Anodyzowany mat	8 Unit/Szt	5148762

Aluminium/Aluminium

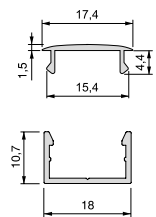
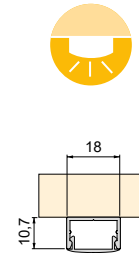
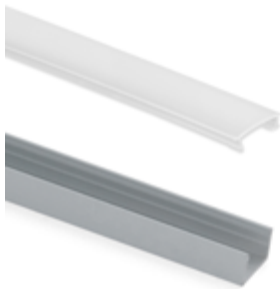

Lynx inclined surface profiles for LED strips
 Nachylony profile do powierzchni do taśm LED



Longitude/Długość	Finishing/Wykończenie	Packaging/Opakowanie	Cod.
2,35 m	Matt anodized/Anodyzowany mat	6 Unit/Szt	5148862

Aluminium/Aluminium

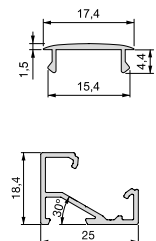
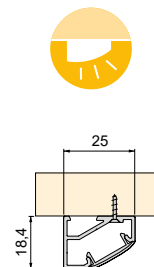

Drawer lighting Oświetlenie szuflad

Taika is a longitudinal LED luminaire with an elegant compact design for illuminating the inside of drawers or cupboards.

Taika to podłużna oprawa LED o eleganckim, kompaktowym designie do oświetlania wnętrza szuflad lub szafek.



12V DC

6W	5211020
15W	5211120
30W	5147420
50W	5147520
72W	5008520
100W	5209320
200W	5209420

It is suitable for installation in 500, 600, 800 and 900 mm wide modules with a board thickness of 16 to 19 mm, depending on the model selected.

Nadaje się do montażu w modułach o szerokości 500, 600, 800 i 900 mm i grubości płyty od 16 do 19 mm, w zależności od wybranego modelu.



16 mm



18 mm



19 mm

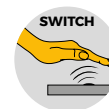
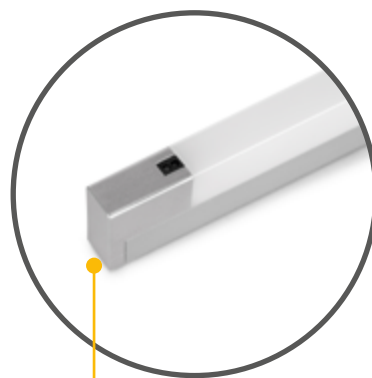

It has an integrated proximity sensor, which switches the luminaire on when the drawer is opened and off when it is closed.

Posiada zintegrowany czujnik zbliżeniowy, który włącza oprawę po otwarciu szuflady i wyłącza po jej zamknięciu.

Taika LED drawer luminaire (12V DC)
Oprawa szufladowa Taika LED (12 V DC)

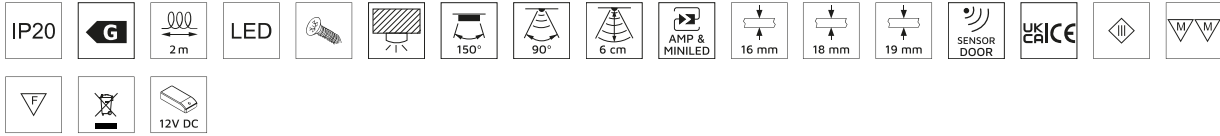

M	L	Lumen	Power/Moc	Colour temperature/ Temperatura koloru	Finishing/Wykończenie	Packaging/ Opakowanie	Cod.
500	462-468	225 lm	4,1 W	Natural white 4.000 K/ Naturalna biel 4.000 K	Matt anodized/ Anodyzowany mat	1 Unit/Szt	5216062
600	562-568	282 lm	5,2 W	Natural white 4.000 K/ Naturalna biel 4.000 K	Matt anodized/ Anodyzowany mat	1 Unit/Szt	5216162
800	762-768	360 lm	6,6 W	Natural white 4.000 K/ Naturalna biel 4.000 K	Matt anodized/ Anodyzowany mat	1 Unit/Szt	5216262
900	862-868	415 lm	7,5 W	Natural white 4.000 K/ Naturalna biel 4.000 K	Matt anodized/ Anodyzowany mat	1 Unit/Szt	5216362

Aluminium, Plastic/Aluminium, Plastik

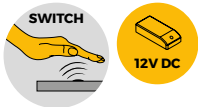

	500	600	800	900
0,25 m	476 lx	597 lx	762 lx	878 lx
0,50 m	173 lx	217 lx	277 lx	319 lx
0,75 m	82 lx	103 lx	132 lx	152 lx
1,00 m	52 lx	65 lx	83 lx	96 lx
1,25 m	35 lx	43 lx	55 lx	64 lx

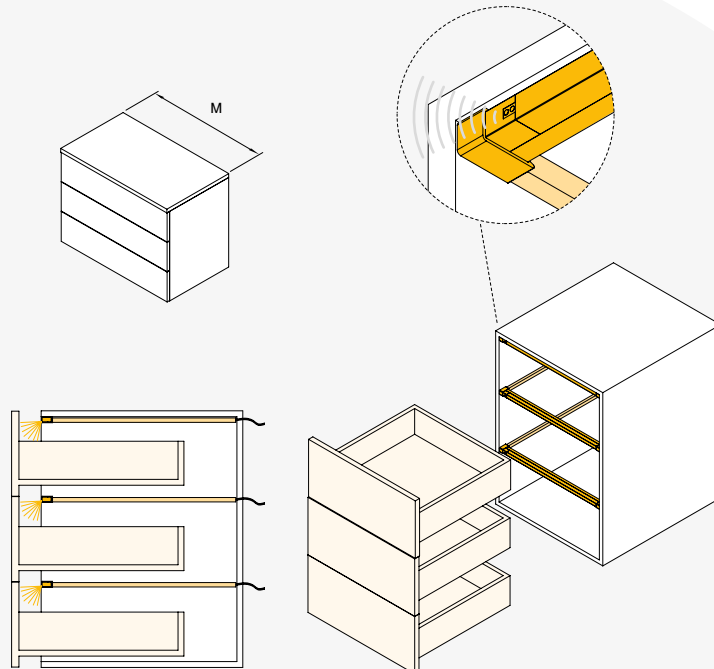
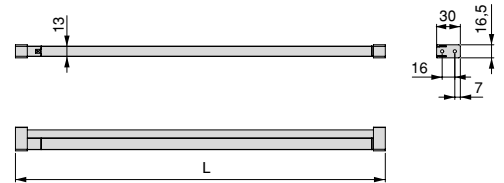

For installation, the brackets are screwed to the sides of the module where the luminaire is fixed. On the side of the module, the 500 mm cable entry profile is fixed with double-sided tape, through which the cable is passed to the rear to prevent it from interfering with the movement of the drawer.

W celu instalacji wsporniki są przykręcane do boków modułu, w którym zamocowana jest oprawa. Z boku modułu za pomocą taśmy dwustronnej mocowany jest profil przepustu kablowego o długości 500 mm, przez który kabel jest przeprowadzany do tyłu, aby zapobiec zakłócaniu ruchu szuflady.

Illuminated mirrors Podświetlane lustra

They are the best functional and decorative solution to illuminate your bathroom or any room, offering uniform, shadow-free lighting that facilitates visibility.

Są najlepszym funkcjonalnym i dekoracyjnym rozwiązaniem do oświetlenia łazienki lub dowolnego pomieszczenia, oferując równomierne, pozbawione cieni oświetlenie, które ułatwia widoczność.

AC 230V
50Hz



They are packaged in a special and exclusive packaging to avoid any breakage, which effectively eliminates the risk of damaging the product during transport.

Są zapakowane w specjalne i ekskluzywne opakowanie, aby uniknąć stłuczenia, co skutecznie eliminuje ryzyko uszkodzenia produktu podczas transportu.



They are resistant to humidity and splash water thanks to their IP44 protection rating.

IP44

Są odporne na wilgoć i bryzgi wody dzięki stopniowi ochrony IP44.

They stand out for their easy installation as they include all the necessary elements for assembly.

Wyróżniają się łatwą instalacją, ponieważ zawierają wszystkie elementy niezbędne do montażu.



Cepheus mirror with LED decorative lighting (AC 230V 50Hz)

Lustro Cepheus z ozdobnym oświetleniem LED (AC 230V 50Hz)



Lumen	Power/Moc	Colour temperature/ Temperatura koloru	LEDs	Finishing/Wykończenie	Packaging/Opakowanie	Cod.
882 lm	12 W	Natural white 4.000 K/ Naturalna biel 4.000 K	129	Not defined/ Nieokreślone	1 Unit/Szt	5150920

Aluminium, Glass/Aluminium, Szkło



Mirror with integrated LED backlighting that can be installed both vertically and horizontally.

Lustro ze zintegrowanym podświetleniem LED, które może być montowane zarówno pionowo, jak i poziomo.

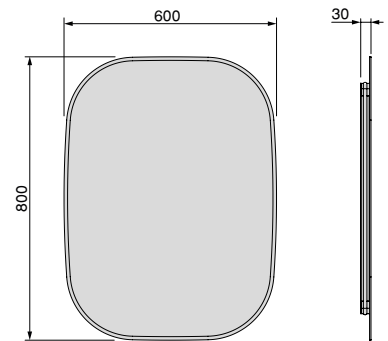

Zeus mirror with LED decorative lighting (AC 230V 50Hz)

Lustro Zeus z ozdobnym oświetleniem LED (AC 230V 50Hz)



Lumen	Power/Moc	Colour temperature/ Temperatura koloru	LEDs	Finishing/Wykończenie	Packaging/Opakowanie	Cod.
850 lm	12 W	Natural white 4.000 K/ Naturalna biel 4.000 K	126	Not defined/ Nieokreślone	1 Unit/Szt	5150820

Aluminium, Glass/Aluminium, Szkło

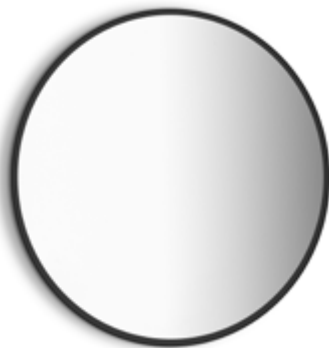

Mirror with integrated LED backlighting.

Lustro ze zintegrowanym podświetleniem LED.

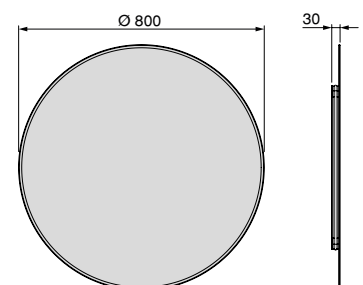

Centaurus mirror with LED decorative lighting (AC 230V 50Hz)

Lustro Centaurus z ozdobnym oświetleniem LED (AC 230V 50Hz)



Lumen	Power/Moc	Colour temperature/ Temperatura koloru	LEDs	Finishing/Wykończenie	Packaging/Opakowanie	Cod.
890 lm	14 W	Natural white 4.000 K/ Naturalna biel 4.000 K	147	Not defined/ Nieokreślone	1 Unit/Szt	5150720

Aluminium, Glass/Aluminium, Szkło

AC 230V
50Hz

IP44



Mirror with integrated LED backlighting that can be installed both vertically and horizontally.

Lustro ze zintegrowanym podświetleniem LED, które można zamontować zarówno pionowo, jak i poziomo.

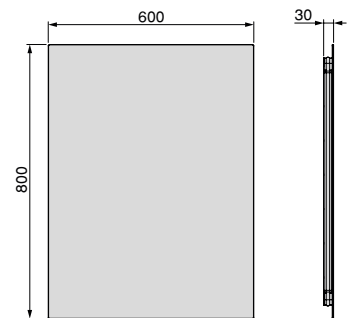

Cassiopeia bathroom mirror with LED decorative lighting (AC 230V 50Hz)

Lustro łazienkowe Cassiopeia z ozdobnym oświetleniem LED (AC 230V 50Hz)



Lumen	Power/Moc	Colour temperature/ Temperatura koloru	Finishing/Wykończenie	Packaging/Opakowanie	Cod.
718 lm	20 W + 12 W	Natural white 4.000 K/ Naturalna biel 4.000 K	Not defined/ Nieokreślone	1 Unit/Szt	5148220

Aluminium, Glass/Aluminium, Szkło

AC 230V
50Hz

IP44

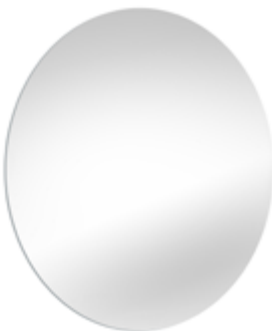

Mirror with LED backlight and anti-fogging system that prevents the mirror from fogging up, thus achieving a mirror that is always clean.

Lustro z podświetleniem LED i systemem zapobiegającym zaparowywaniu, dzięki któremu lustro jest zawsze czyste.

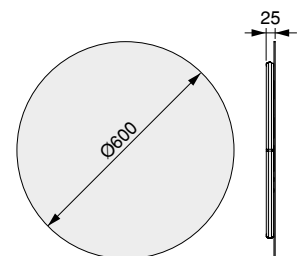

Heracles bathroom mirror with LED front and decorative lighting (AC 230V 50Hz)

Lustro łazienkowe Heracles z oświetleniem LED ozdobnym i z przodu (AC 230V 50Hz)



IP44	silicone	F	1 m	CRI ≥80	LED	120°	AC 230V 50Hz	UK ENEC				
Lumen	Power/Moc	Colour temperature/ Temperatura koloru		Finishing/Wykończenie		Packaging/Opakowanie		Cod.				
1728 lm	11 W + 12 W	Natural white 4.000 K/ Naturalna biel 4.000 K		Not defined/Nieokreślone		1 Unit/Szt		5151020				

Aluminium, Glass/Aluminium, Szkło



Mirror with front LED light and backlight. It has an integrated touch switch that turns on the light and activates the anti-fogging system.

Lustro z przednim oświetleniem LED i podświetleniem. Posiada zintegrowany przełącznik dotykowy, który włącza oświetlenie i aktywuje system zapobiegający parowaniu.

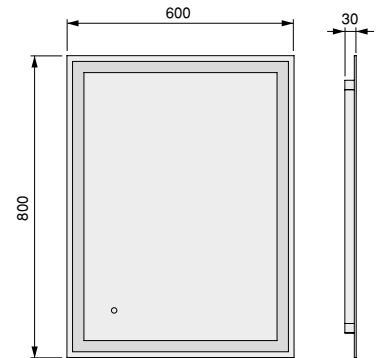

Pegasus bathroom mirror with LED front lighting (AC 230V 50Hz)

Lustro łazienkowe Pegasus z oświetleniem LED z przodu (AC 230V 50Hz)



IP44	E	1 m	CRI ≥80	LED	120°	AC 230V 50Hz	UK ENEC				
Lumen	Power/Moc	Colour temperature/ Temperatura koloru		Finishing/Wykończenie		Packaging/Opakowanie		Cod.			
414 lm	6 W	Natural white 4.000 K/ Naturalna biel 4.000 K		Not defined/Nieokreślone		1 Unit/Szt		5148120			

Aluminium, Glass/Aluminium, Szkło



Mirror with front LED light and anti-corrosion treatment that prevents the mirror from rusting around the edges.

Lusterko z przednim oświetleniem LED i powłoką antykorozyjną, która zapobiega rdzewieniu lusterka na krawędziach.

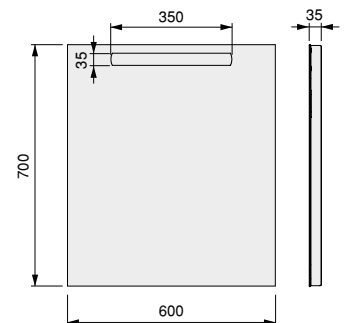

Bathroom lights Oświetlenie łazienkowe

They are designed to illuminate the mirror area, as they project light towards the face, providing uniform, glare-free illumination.

Zostały zaprojektowane tak, aby oświetlać obszar lustra, ponieważ emitują światło w kierunku twarzy, zapewniając równomierne, nieoślepiające oświetlenie.

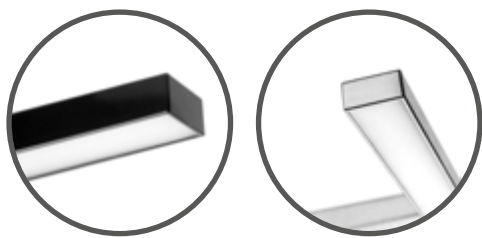

They have the latest technology in LED lighting systems and do not need a power transformer because they operate at 230V AC.

Posiadają najnowszą technologię w systemach oświetlenia LED i nie wymagają transformatora zasilającego, ponieważ działają przy napięciu 230 V AC.

AC 230V
50Hz

They are resistant to humidity and water splashes thanks to their IP44 protection rating.

IP44

Są odporne na wilgoć i zachłapanie wodą dzięki stopniowi ochrony IP44.

They stand out for their easy installation as they have a hook for mounting on glass, board or on the surface of the furniture, with screws included.

Wyróżniają się łatwą instalacją, ponieważ posiadają hak do montażu na szkle, płycie lub na powierzchni mebla, z dołączonymi śrubami.

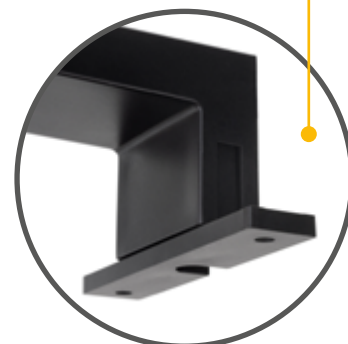

Leo LED bathroom mirror spotlight (AC 230V 50Hz)

Reflektor LED do lustra łazienkowego Leo (AC 230V 50Hz)



Lumen	Power/Moc	Colour temperature/ Temperatura koloru	LEDs	Finishing/Wykończenie	Packaging/ Opakowanie	Cod.
457 lm	6 W	Cold white 5.700 K/ Zimna biel 5.700 K	60	Black painted/ Malowane na czarno	5 Unit/Szt	5150114

Plastic/Plastik

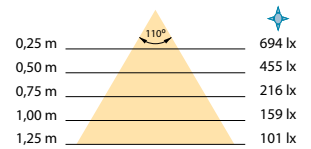
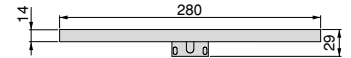
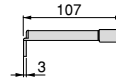

Virgo LED bathroom mirror spotlight (AC 230V 50Hz)

Reflektor LED do lustra łazienkowego Virgo (AC 230V 50Hz)

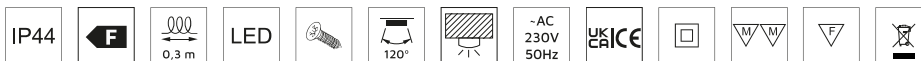

Lumen	Power/Moc	Colour temperature/ Temperatura koloru	LEDs	Finishing/Wykończenie	Packaging/ Opakowanie	Cod.
400 lm	6 W	Cold white 6.000 K/ Zimna biel 6.000 K	60	Chrome plated/ Chromowane	5 Unit/Szt	5149111
400 lm	6 W	Cold white 6.000 K/ Zimna biel 6.000 K	60	Black painted/ Malowane na czarno	5 Unit/Szt	5149114

Plastic/Plastik

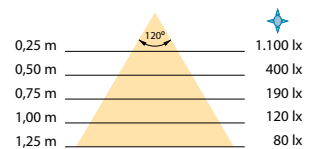
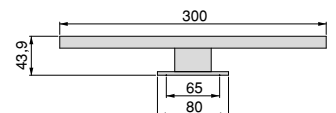
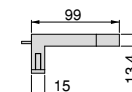

Gemini LED bathroom mirror spotlight (AC 230V 50Hz)

Reflektor LED do lustra łazienkowego Gemini (AC 230V 50Hz)

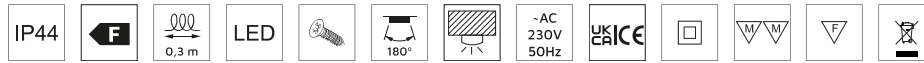

Lumen	Power/Moc	Colour temperature/ Temperatura koloru	Finishing/Wykończenie	Packaging/Opakowanie	Cod.
392 lm	6 W	Natural white 4.000 K/ Naturalna biel 4.000 K	Chrome plated/ Chromowane	5 Unit/Szt	5150011
392 lm	6 W	Natural white 4.000 K/ Naturalna biel 4.000 K	Black painted/ Malowane na czarno	5 Unit/Szt	5150014

Aluminium, Plastic/Aluminium, Plastik

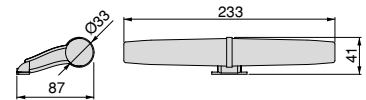
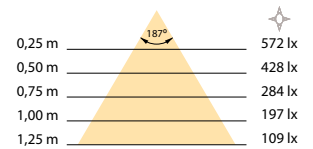

They stand out for their easy installation as they include all the necessary elements for assembly.

Wyróżniają się łatwą instalacją, ponieważ zawierają wszystkie elementy niezbędne do montażu.

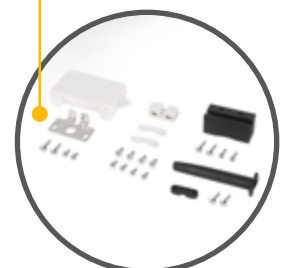

Aries LED bathroom mirror spotlight (AC 230V 50Hz)

Reflektor LED do lustra łazienkowego Aries (AC 230V 50Hz)



Lumen	Power/Moc	Colour temperature/ Temperatura koloru	Finishing/Wykończenie	Packaging/Opakowanie	Cod.
599 lm	7 W	Cold white 5.700 K/ Zimna biel 5.700 K	Chrome plated/ Chromowane	5 Unit/Szt	5150211

Aluminium, Plastic/Aluminium, Plastik

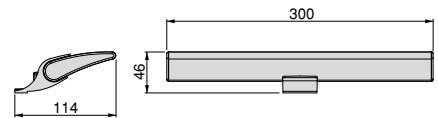
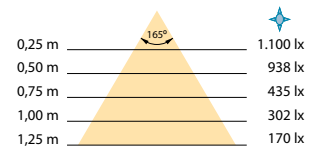

Aquarius LED lamp over mirror 300 - 450 mm (AC 230V 50Hz)

Kinkiet LED do lustra łazienkowego Aquarius 300 - 450 mm (AC 230V 50Hz)

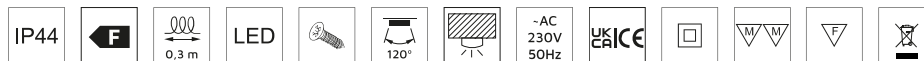

A	Lumen	Power/Moc	Colour temperature/ Temperatura koloru	LEDs	Finishing/Wykończenie	Packaging/ Opakowanie	Cod.
300	520 lm	7 W	Cold white 6.000 K/ Zimna biel 6.000 K	60	Chrome plated/ Chromowane	5 Unit/Szt	5145311
450	480 lm	7 W	Cold white 6.000 K/ Zimna biel 6.000 K	60	Chrome plated/ Chromowane	5 Unit/Szt	5145411

Aluminium, Plastic/Aluminium, Plastik

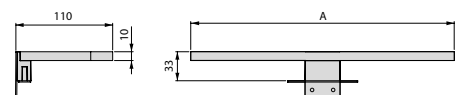
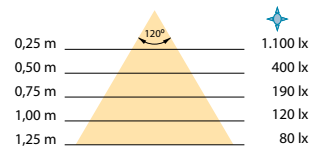

Battery operated Z baterią

Luminaires with rechargeable batteries allow lighting in kitchens and cupboards without the need for wiring or complicated installation.

Oprawy zasilane akumulatorowo umożliwiają oświetlenie kuchni i szafek, bez konieczności prowadzenia okablowania lub skomplikowanej instalacji.



Proximity detection system that switches the luminaire on or off when its detection range is interfered with.

System detekcji zbliżeniowej, który włącza lub wyłącza oprawę, gdy jej zasięg detekcji zostanie zakłócony.



Motion detection system that switches the luminaire on when its detection range is interfered with.

System wykrywania ruchu, który włącza oprawę, gdy jej zasięg wykrywania zostanie zakłócony.

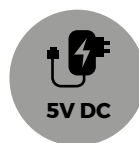

Rechargeable lithium polymer battery that can be recharged with a conventional 5V DC mobile phone charger.

Akumulator litowo-polimerowy, który można ładować za pomocą zwykłej ładowarki do telefonu komórkowego 5 V DC.

Kaus Black USB rechargeable LED wall light with motion sensor
Lampa ścienna LED Kaus Black ładowana przez USB z czujnikiem ruchu



L	Lumen	Power/Moc	Colour temperature/ Temperatura koloru	Finishing/Wykończenie	Packaging/ Opakowanie	Cod.
240	60 lm	1 W	Natural white 4,000 K/ Naturalna biel 4,000 K	Black painted/ Malowane na czarno	1 Unit/Szt	5214114
400	120 lm	2 W	Natural white 4,000 K/ Naturalna biel 4,000 K	Black painted/ Malowane na czarno	1 Unit/Szt	5214214
600	180 lm	3 W	Natural white 4,000 K/ Naturalna biel 4,000 K	Black painted/ Malowane na czarno	1 Unit/Szt	5214314

Aluminium, Plastic/Aluminium, Plastik

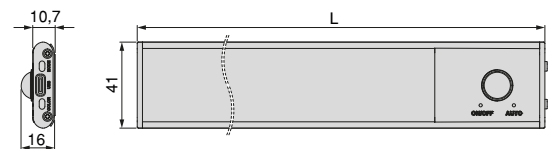
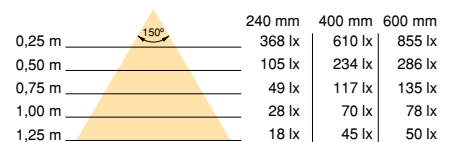
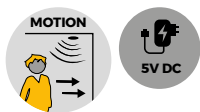

Kaus Black USB rechargeable LED wall light with proximity sensor
Sistema de iluminação LED recarregável por USB Kaus Black com sensor de proximidade



L	Lumen	Power/Moc	Colour temperature/ Temperatura koloru	Finishing/Wykończenie	Packaging/ Opakowanie	Cod.
240	60 lm	1 W	Natural white 4,000 K/ Naturalna biel 4,000 K	Black painted/ Malowane na czarno	1 Unit/Szt	5214414
400	120 lm	2 W	Natural white 4,000 K/ Naturalna biel 4,000 K	Black painted/ Malowane na czarno	1 Unit/Szt	5214514
600	180 lm	3 W	Natural white 4,000 K/ Naturalna biel 4,000 K	Black painted/ Malowane na czarno	1 Unit/Szt	5214614

Aluminium, Plastic/Aluminium, Plastik

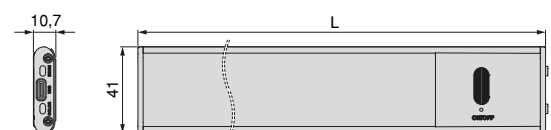
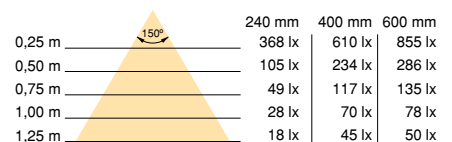
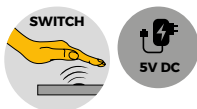

Kaus USB rechargeable LED wall light with motion sensor

Lampa ścienna LED Kaus ładowana przez USB z czujnikiem ruchu



L	Lumen	Power/Moc	Colour temperature/ Temperatura koloru	Finishing/Wykończenie	Packaging/ Opakowanie	Cod.
240	60 lm	1 W	3.000 K - 4.000 K - 6.000 K	Matt anodized/ Anodyzowany mat	1 Unit/Szt	5213462
400	120 lm	2 W	3.000 K - 4.000 K - 6.000 K	Matt anodized/ Anodyzowany mat	1 Unit/Szt	5213562
600	180 lm	3 W	3.000 K - 4.000 K - 6.000 K	Matt anodized/ Anodyzowany mat	1 Unit/Szt	5213662

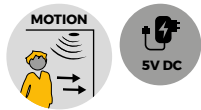

30 cm USB-C charging cable included.
W zestawie kabel ładowający USB-C o długości 30 cm.

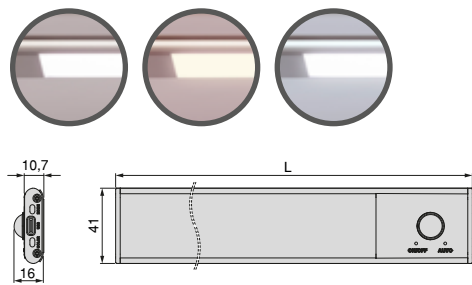

Aluminium, Plastic/Aluminium, Plastik

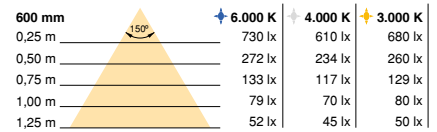
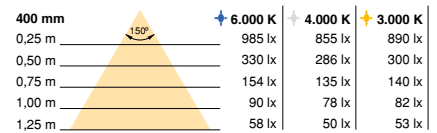
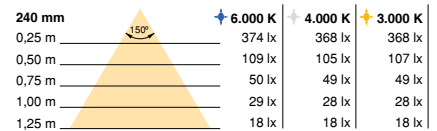

Kaus USB rechargeable LED wall light with proximity touch sensor

Lampka ścienna LED Kaus ładowana przez USB z dotykowym czujnikiem zbliżeniowym



L	Lumen	Power/Moc	Colour temperature/ Temperatura koloru	Finishing/Wykończenie	Packaging/ Opakowanie	Cod.
240	60 lm	1 W	3.000 K - 4.000 K - 6.000 K	Matt anodized/ Anodyzowany mat	1 Unit/Szt	5213762
400	120 lm	2 W	3.000 K - 4.000 K - 6.000 K	Matt anodized/ Anodyzowany mat	1 Unit/Szt	5213862
600	180 lm	3 W	3.000 K - 4.000 K - 6.000 K	Matt anodized/ Anodyzowany mat	1 Unit/Szt	5213962



30 cm USB-C charging cable included.
W zestawie kabel ładowający USB-C o długości 30 cm.

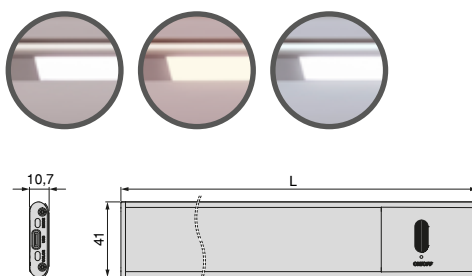

Aluminium, Plastic/Aluminium, Plastik

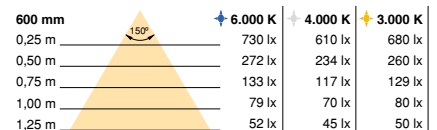
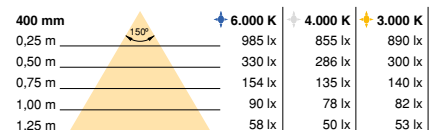
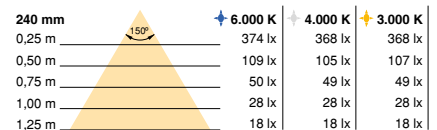

Rigel USB rechargeable LED light for inside drawers with vibration sensor

Lampka LED Rigel ładowana przez USB do szuflad wewnętrznych z czujnikiem wibracji

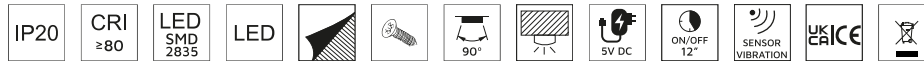

Lumen	Power/Moc	Colour temperature/ Temperatura koloru	LEDs	Finishing/Wykończenie	Packaging/ Opakowanie	Cod.
75 lm	1 W	Natural white 4,000 K/ Naturalna biel 4,000 K	10	Silver painted/Malowa- ne aluminium	5 Unit/Szt	5214025

Plastic/Plastik

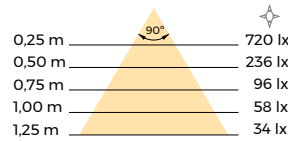
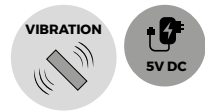

It has a sensor that detects the vibration of the drawer when it is opened and turns on the luminaire.

Posiada czujnik, który wykrywa wibracje szuflady po jej otwarciu i włącza oprawę.

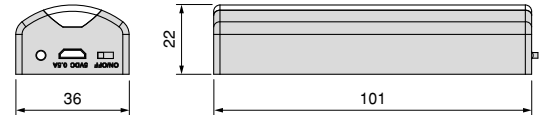

Kraz Rechargeable LED light with movement sensor

Oprawa LED zasilanie akumulatorowe, czujnik ruchu



Lumen	Power/Moc	Colour temperature/ Temperatura koloru	LEDs	Finishing/Wykończenie	Packaging/ Opakowanie	Cod.
85 lm	1 W	Natural white 4,000 K/ Naturalna biel 4,000 K	9	Silver painted/Malowa- ne aluminium	5 Unit/Szt	5028625

Plastic/Plastik

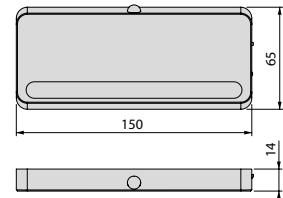
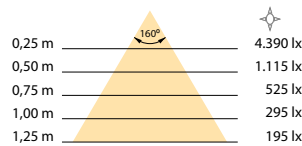
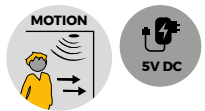

Crater LED light rechargeable by USB and with motion sensor

Kinkiet LED, zasilanie akumulatorowe przez USB, czujnik ruchu, Crater



Lumen	Power/Moc	Colour temperature/ Temperatura koloru	LEDs	Finishing/Wykończenie	Packaging/ Opakowanie	Cod.
110 lm	1 W	Natural white 4,000 K/ Naturalna biel 4,000 K	28	Silver painted/Malowa- ne aluminium	5 Unit/Szt	5023925

Plastic/Plastik

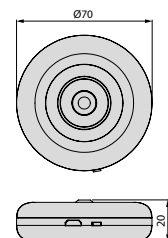
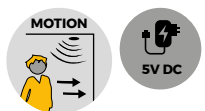

Illuminated hanging bars Podświetlane drążki na wieszaki

They are ideal for illuminating the inside of your wardrobes or dressing rooms with an elegant, practical and functional design.

Idealnie nadają się do oświetlenia wnętrza szaf lub garderoby dzięki eleganckiemu, praktycznemu i funkcjonalnemu wzornictwu.



Motion detection system that turns the luminaire on when its detection range is interfered with.

System wykrywania ruchu, który włącza oprawę, gdy jej zasięg wykrywania zostanie zakłócony.



Polux Hanging wardrobe bar with LED light with motion sensor (12V DC)

Drążek do szafy z oświetleniem LED, czujnik ruchu, Polux (12V DC)

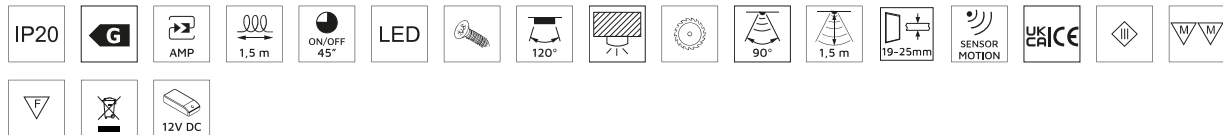

A	L	Cut/Obcinane	Lumen	Power/Moc	Colour temperature/ Temperatura koloru	LEDs	Finishing/Wykończenie	Packaging/ Opakowanie	Cod.
558	547	408-558	125 lm	2.6 W	Natural white 4.000 K/ Naturalna biel 4.000 K	32	Matt anodized/ Anodyzowany mat	1 Unit/Szt	5074562
708	697	558-708	160 lm	3.3 W	Natural white 4.000 K/ Naturalna biel 4.000 K	41	Matt anodized/ Anodyzowany mat	1 Unit/Szt	5074662
858	847	708-858	190 lm	4 W	Natural white 4.000 K/ Naturalna biel 4.000 K	50	Matt anodized/ Anodyzowany mat	1 Unit/Szt	5074762
1.008	997	858-1.008	230 lm	4,8 W	Natural white 4.000 K/ Naturalna biel 4.000 K	59	Matt anodized/ Anodyzowany mat	1 Unit/Szt	5074862
1.158	1.147	1.008-1.158	260 lm	5,5 W	Natural white 4.000 K/ Naturalna biel 4.000 K	68	Matt anodized/ Anodyzowany mat	1 Unit/Szt	5074962

Aluminium, Plastic/Aluminium, Plastik

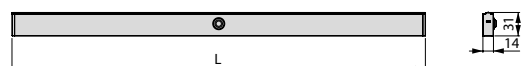
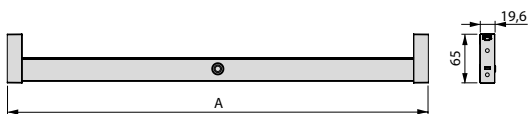
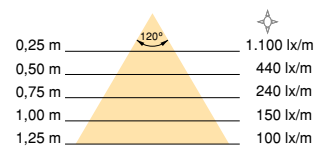
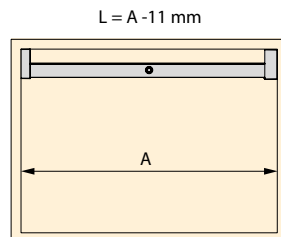
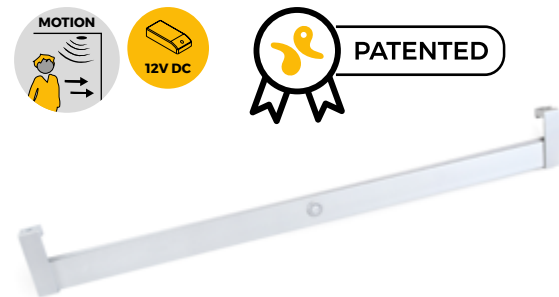

The cod. 5077962 included the central rail support. Does not include LED converter.

Kod 5077962 zawiera w komplecie wspornik środkowy drążka. Nie uwzględnia konwertera LED.



Castor Hanging wardrobe bar with LED light, removable battery and motion sensor
 Drażek do szafy z oświetleniem LED, wymienna bateria, czujnik ruchu, Castor



A	L	Cut/Obcinane	Lumen	Power/Moc	Colour temperature/ Temperatura koloru	LEDs	Finishing/Wykończenie	Packaging/ Opakowanie	Cod.
558	547	408-558	30 lm	0,6 W	Natural white 4,000 K/ Naturalna biel 4,000 K	30	Moka painted/ Malowane na kolor mokka	1 Unit/Szt	5074013
708	697	558-708	35 lm	0,7 W	Natural white 4,000 K/ Naturalna biel 4,000 K	45	Moka painted/ Malowane na kolor mokka	1 Unit/Szt	5074113
858	847	708-858	45 lm	0,9 W	Natural white 4,000 K/ Naturalna biel 4,000 K	60	Moka painted/ Malowane na kolor mokka	1 Unit/Szt	5074213
1.008	997	858-1.008	50 lm	1 W	Natural white 4,000 K/ Naturalna biel 4,000 K	75	Moka painted/ Malowane na kolor mokka	1 Unit/Szt	5074313
1.158	1.147	1.008-1.158	55 lm	1,2 W	Natural white 4,000 K/ Naturalna biel 4,000 K	90	Moka painted/ Malowane na kolor mokka	1 Unit/Szt	5074413
558	547	408-558	30 lm	0,6 W	Natural white 4,000 K/ Naturalna biel 4,000 K	30	Matt anodized/ Anodyzowany mat	1 Unit/Szt	5074062
708	697	558-708	35 lm	0,7 W	Natural white 4,000 K/ Naturalna biel 4,000 K	45	Matt anodized/ Anodyzowany mat	1 Unit/Szt	5074162
858	847	708-858	45 lm	0,9 W	Natural white 4,000 K/ Naturalna biel 4,000 K	60	Matt anodized/ Anodyzowany mat	1 Unit/Szt	5074262
1.008	997	858-1.008	50 lm	1 W	Natural white 4,000 K/ Naturalna biel 4,000 K	75	Matt anodized/ Anodyzowany mat	1 Unit/Szt	5074362
1.158	1.147	1.008-1.158	55 lm	1,2 W	Natural white 4,000 K/ Naturalna biel 4,000 K	90	Matt anodized/ Anodyzowany mat	1 Unit/Szt	5074462

Aluminium, Plastic/
Aluminium, Plastik

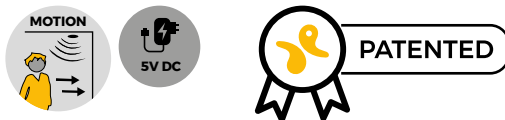

L = A - 11 mm

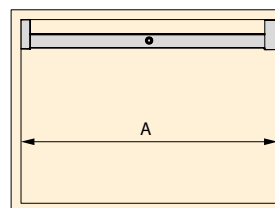

0,25 m	240 lx/m
0,50 m	100 lx/m
0,75 m	55 lx/m
1,00 m	35 lx/m
1,25 m	25 lx/m

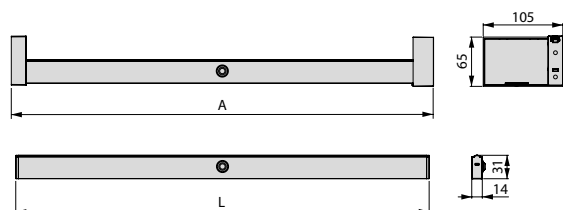

Functioning with an extractable battery, which can be recharged using a 5V DC 1A mobile charger with a micro USB type B port. The cod. 5077413 and 5077462 included the central rail support.

Działa dzięki zasilaniu bateryjnemu, które można doładowywać z wykorzystaniem przenośnej ładowarki na prąd stały 5V 1A z mikroportem USB typu B. Kod 5077413 i 5077462 zawiera w komplecie wspornik środkowy drążka.

Lights Kinkiety

These luminaires are designed to create pleasant and functional environments, ideal as a direct reading light at the head of the bed.

Oprawy te zostały zaprojektowane z myślą o tworzeniu przyjemnego i funkcjonalnego otoczenia, idealnego jako bezpośrednie światło do czytania u wezgłowia łóżka.



12V DC

6W	5211020
15W	5211120
30W	5147420
50W	5147520
72W	5008520
100W	5209320
200W	5209420



You can adjust and orient the light according to your needs, thanks to their flexible arms.

Dzięki elastycznym ramionom można regulować i ustawiać światło w zależności od potrzeb.

Directional Quasar LED luminaire for reading (12V DC) Oprawa LED Quasar do odczytu kierunkowego (12 V DC)



Lumen	Power/Moc	Colour temperature/ Temperatura koloru	Input	Finishing/Wykończenie	Packaging/ Opakowanie	Cod.
166 lm	3 W	Natural white 4,000 K/ Naturalna biel 4,000 K	12V DC	White plastic/ Biały plastik	1 Unit/Szt	5218315

Plastic/Plastik

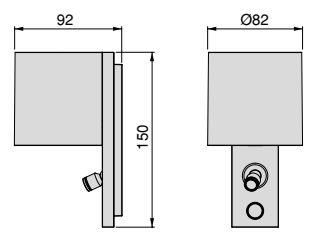
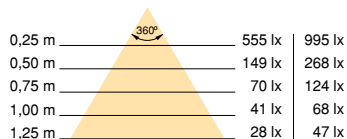
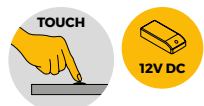

Luminaria LED Alioth flexible con puerto de carga USB-A de 5V DC-1A Max. (12V DC)

Luminária LED Alioth flexível com porta de carregamento USB-A 5V DC-1A Max. (12V DC)



Lumen	Power/Moc	Colour temperature/ Temperatura koloru	Input	Output	Finishing/Wykończenie	Packaging/ Opakowanie	Cod.
68 lm	1,2 W	Natural white 4.000 K/ Naturalna biel 4.000 K	12V DC Min 15W	5V DC 1A Max.	Black painted/ Malowane na czarno	1 Unit/Szt	5218114

Plastic/Plastik

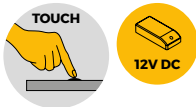

Luminaria LED Algal flexible con puerto de carga USB-A de 5V DC-1A Max. (12V DC)

Elastyczna oprawa LED Algal z portem ładowania USB-A 5V DC-1A maks. (12V DC)



Lumen	Power/Moc	Colour temperature/ Temperatura koloru	Input	Output	Finishing/Wykończenie	Packaging/ Opakowanie	Cod.
93 lm	1,8 W	Natural white 4.000 K/ Naturalna biel 4.000 K	12V DC Min 15W	5V DC 1A Max.	Black painted/ Malowane na czarno	1 Unit/Szt	5218214

Plastic/Plastik

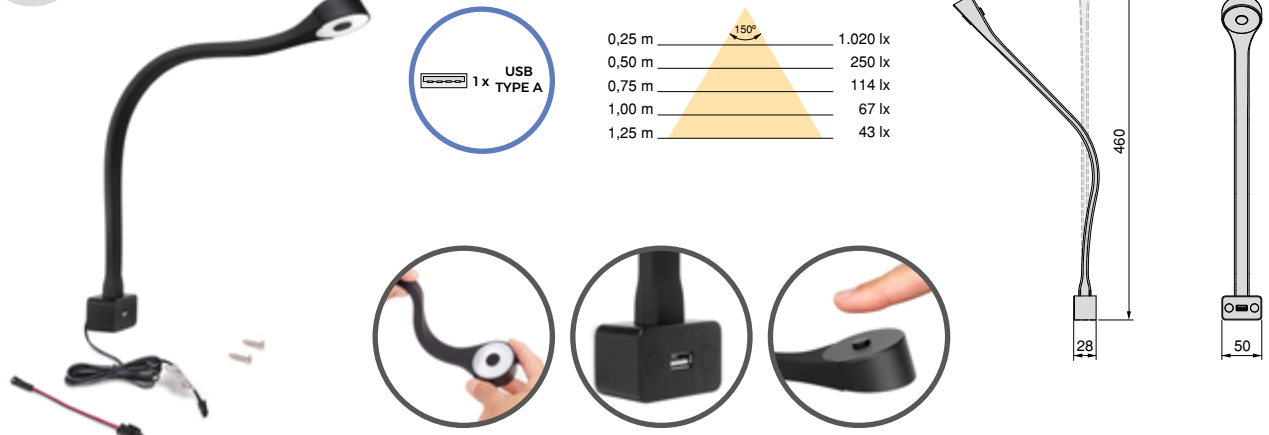
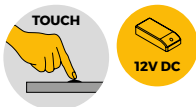

Lights Kinkiety

They are the classic way to illuminate your furniture in a practical and functional way, with the best LED technology.

To klasyczny sposób na oświetlenie mebli w praktyczny i funkcjonalny sposób, przy użyciu najlepszej technologii LED.

**AC 230V
50Hz**

12V DC

6W	5211020
15W	5211120
30W	5147420
50W	5147520
72W	5008520
100W	5209320
200W	5209420



LED spotlight Crux (12V DC) Światło LED Crux (12V DC)



Lumen	Power/Moc	Colour temperature/ Temperatura koloru	LEDs	Finishing/Wykończenie	Packaging/ Opakowanie	Cod.
105 lm	1,8 W	Cold white 6.000 K/ Zimna biel 6.000 K	24	Silver painted/Malowane aluminium	6 Unit/Szt	5914525
105 lm	1,8 W	Cold white 6.000 K/ Zimna biel 6.000 K	24	Satin finished nickel/ Nikiel satynowy	6 Unit/Szt	5914551
110 lm	1,8 W	Natural white 4.500 K/ Naturalna biel 4.500 K	24	Satin finished nickel/ Nikiel satynowy	6 Unit/Szt	5914651

Plastic/Plastik

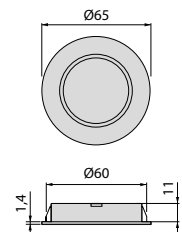
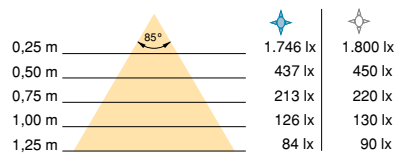

Crux-in LED luminaire for embedding in furniture without the need for a converter (AC 230V 50Hz)
Oprawa Crux-in LED do osadzenia w meblach bez potrzeby stosowania konwertera (AC 230V 50Hz)

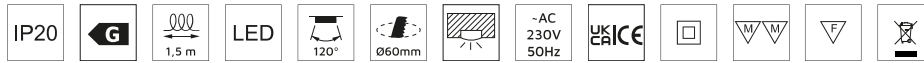

Lumen	Power/Moc	Colour temperature/ Temperatura koloru	LEDs	Finishing/Wykończenie	Packaging/ Opakowanie	Cod.
116 lm	1,8 W	Cold white 6.000 K/ Zimna biel 6.000 K	24	Silver painted/Malowa- ne aluminium	6 Unit/Szt	5915225
116 lm	1,8 W	Cold white 6.000 K/ Zimna biel 6.000 K	24	Satin finished nickel/ Nikiel satynowy	6 Unit/Szt	5915251
116 lm	1,8 W	Natural white 4.000 K/ Naturalna biel 4.000 K	24	Satin finished nickel/ Nikiel satynowy	6 Unit/Szt	5915351

Plastic/Plastik

AC 230V
50Hz

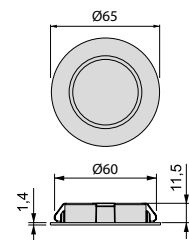
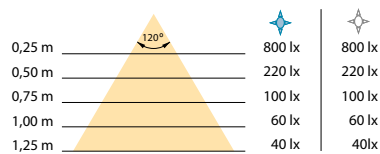

LED spotlight Crux-in-Q (AC 230V 50Hz)
Światło LED Crux-in-Q (AC 230V 50Hz)

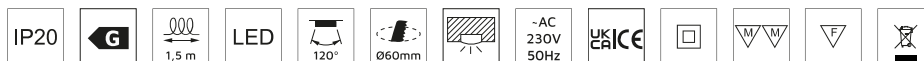

Lumen	Power/Moc	Colour temperature/ Temperatura koloru	LEDs	Finishing/Wykończenie	Packaging/ Opakowanie	Cod.
101 lm	1,8 W	Natural white 4.000 K/ Naturalna biel 4.000 K	24	Black painted/Malowa- ne na czarno	6 Unit/Szt	5203914
101 lm	1,8 W	Natural white 4.000 K/ Naturalna biel 4.000 K	24	Satin finished nickel/ Nikiel satynowy	6 Unit/Szt	5203951

Plastic/Plastik

AC 230V
50Hz

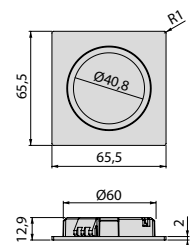
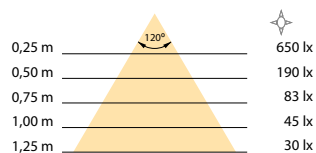

Mizar LED luminaire for embedding in furniture without the need for a converter (AC 230V 50Hz)
Mizar LED do osadzania w meblach bez potrzeby stosowania konwertera (AC 230V 50Hz)

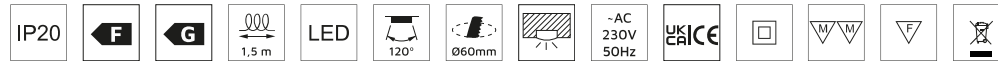

A	Diametre/ Średnica	Lumen	Power/Moc	Colour temperature/ Temperatura koloru	LEDs	Finishing/Wykończenie	Packaging/ Opakowanie	Cod.
66	66	200 lm	3 W	Natural white 4,000 K/ Naturalna biel 4,000 K	24	Satin finished nickel/ Nikiel satynowy	6 Unit/Szt	5040151

Plastic, Steel/Plastik, Stal

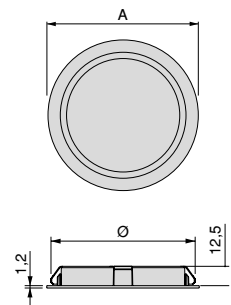
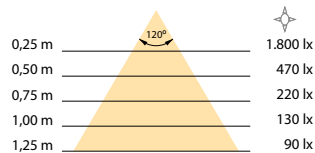

LED spotlight Polaris (12V DC)
Światło LED Polaris (12V DC)



Lumen	Power/Moc	Colour temperature/ Temperatura koloru	LEDs	Finishing/Wykończenie	Packaging/ Opakowanie	Cod.
95 lm	1,2 W	Natural white 4,000 K/ Naturalna biel 4,000 K	1	Matt anodized/ Anodizowany mat	6 Unit/Szt	5022262

Aluminium/Aluminium

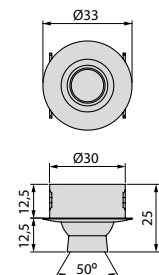

LED spotlight Spot (12V DC)
Światło LED Spot (12V DC)

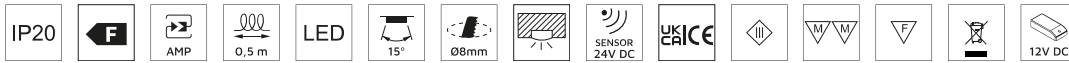

Lumen	Power/Moc	Colour temperature/ Temperatura koloru	LEDs	Finishing/Wykończenie	Packaging/ Opakowanie	Cod.
8 lm	0.3 W	Cold white 6.000 K/ Zimna biel 6.000 K	1	Chrome plated/ Chromowane	10 Unit/Szt	7015611

Plastic/Plastik

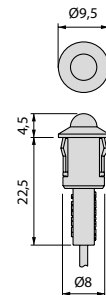
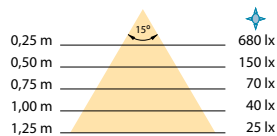

LED spotlight Alcor (12V DC)
Światło LED Alcor (12V DC)



Lumen	Power/Moc	Colour temperature/ Temperatura koloru	LEDs	Finishing/Wykończenie	Packaging/ Opakowanie	Cod.
95 lm	1,2 W	Natural white 4.000 K/ Naturalna biel 4.000 K	1	Matt anodized/ Anodizowany mat	6 Unit/Szt	5022362

Aluminium/Aluminium

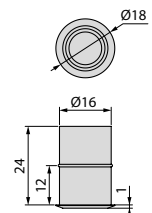

Basic installations Podstawowe instalacje

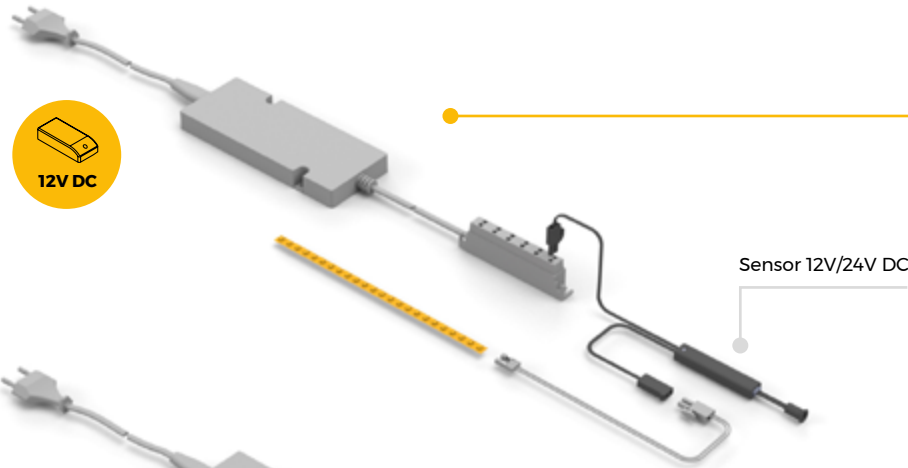

Installation **12V DC**
Instalacja **12V DC**

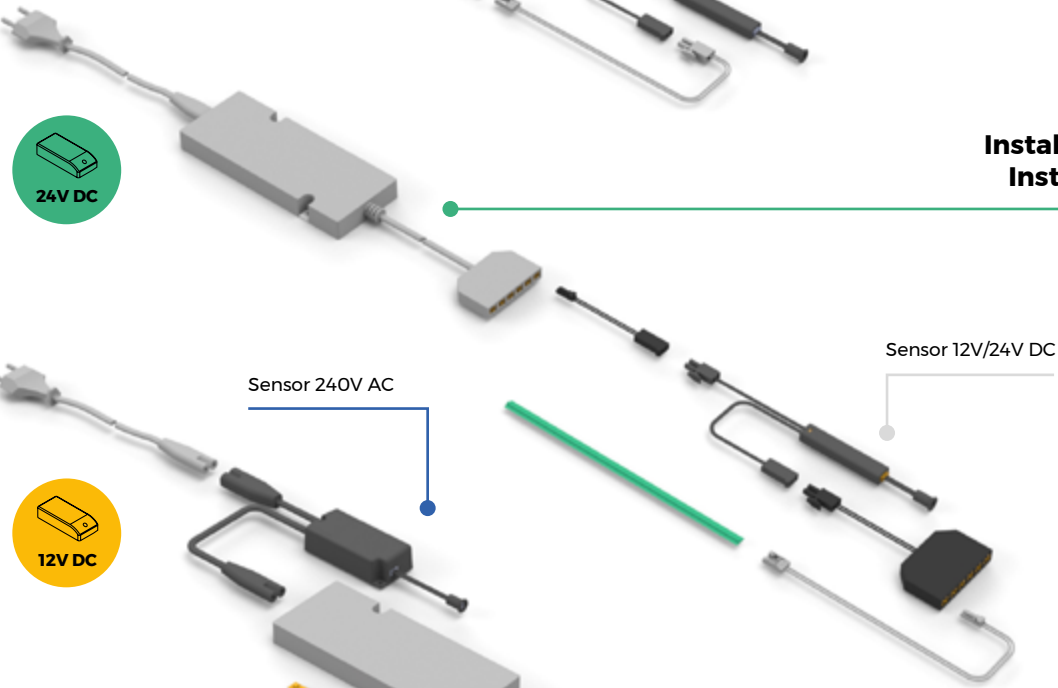

Installation **24V DC**
Instalacja **24V DC**

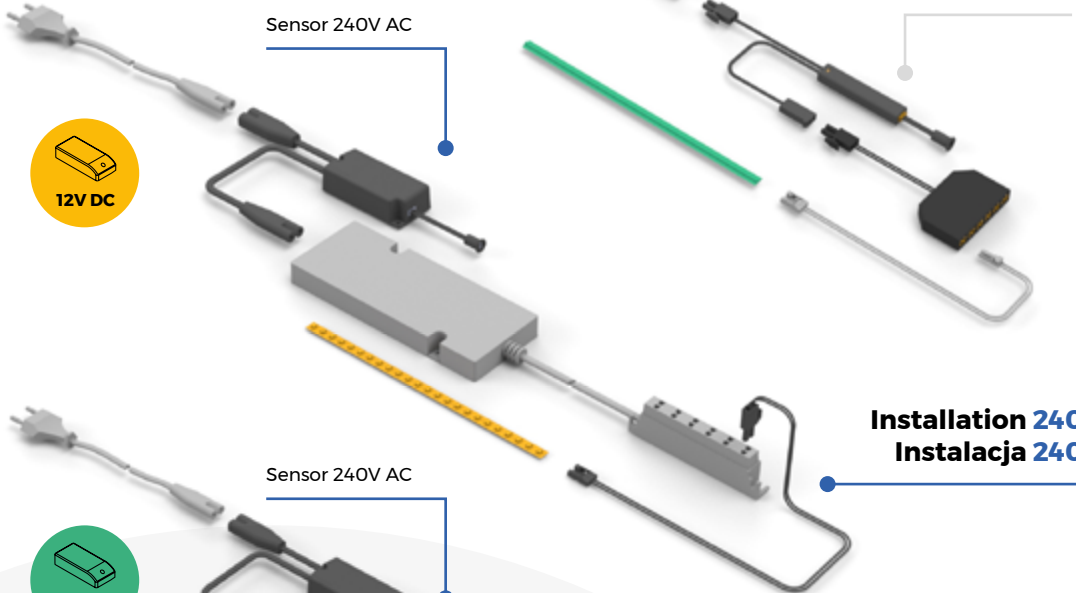

Installation **240V AC - 12V DC**
Instalacja **240V AC - 12V DC**

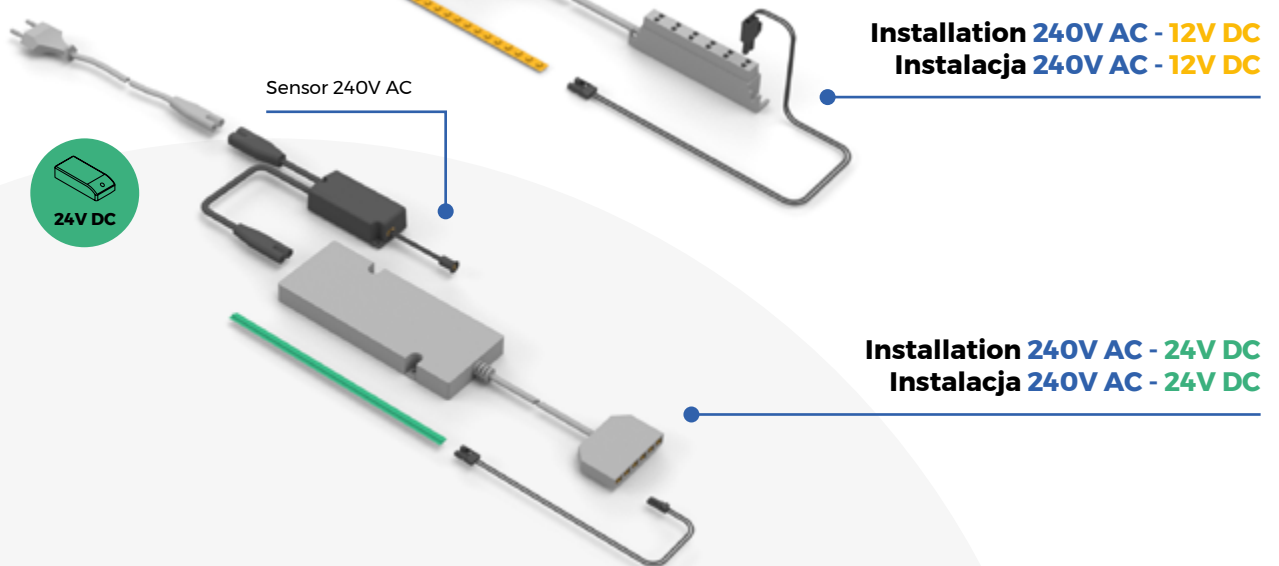

Installation **240V AC - 24V DC**
Instalacja **240V AC - 24V DC**



6W	5211020
15W	5211120
30W	5147420
50W	5147520
72W	5008520
100W	5209320
200W	5209420



15W	5211220
30W	5147620
50W	5147720
100W	5209520

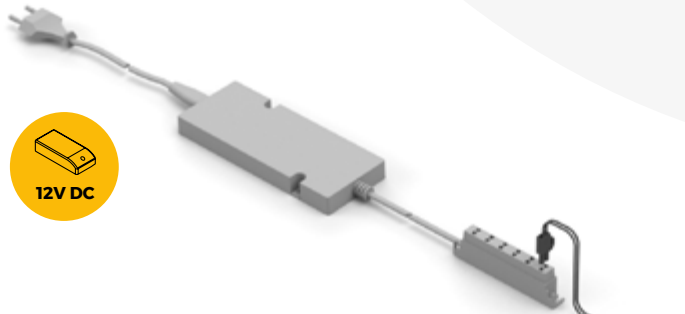

Installation Lynx 12V DC
Instalacja Lynx 12V DC

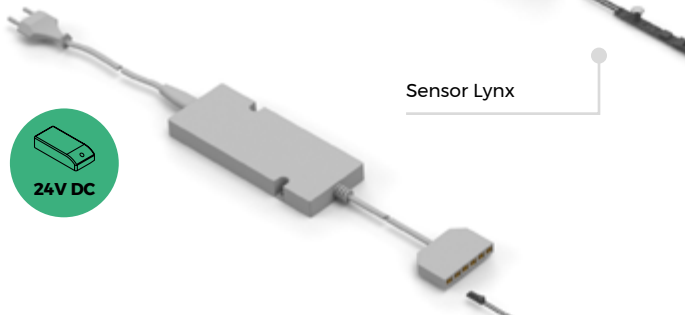

Installation Lynx 24V DC
Instalacja Lynx 24V DC

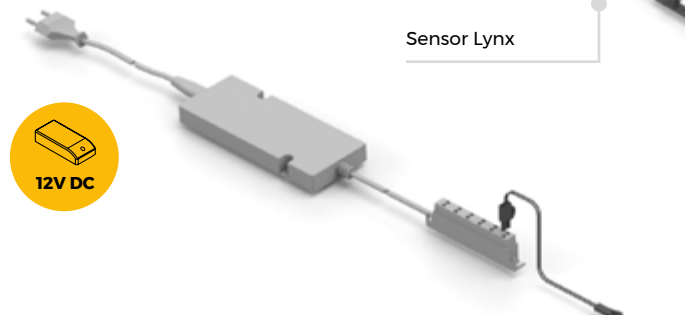

Installation Wirly 12V DC
Instalacja Wirly 12V DC

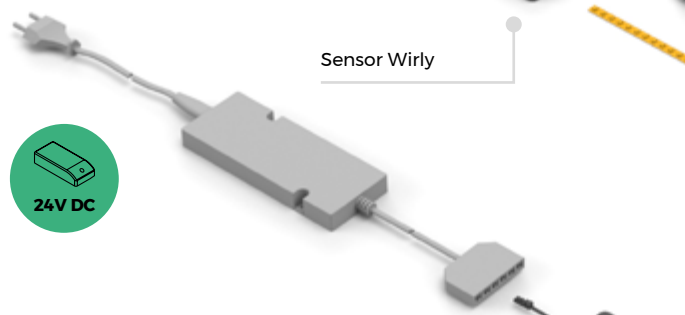

Installation Wirly 24V DC
Instalacja Wirly 24V DC

Constant-voltage converter for LED lights, plastic (12V DC)
Zasilacz napięcia stałego do opraw LED, plastik (12V DC)

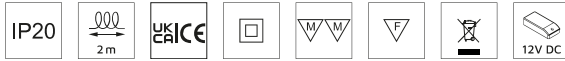

A	B	C	Power/Moc	Input	Output	Finishing/Wykończenie	Packaging/Opakowanie	Cod.
16,2	96	41	6 W	180-240V AC - 50Hz	12V DC	Not defined/ Nieokreślone	<input type="checkbox"/>	10 Unit/Szt 5211020
16,2	96	41	15 W	180-240V AC - 50Hz	12V DC	Not defined/ Nieokreślone	<input type="checkbox"/>	10 Unit/Szt 5211120
17	164	65	30 W	100-240V AC - 50-60Hz	12V DC	Not defined/ Nieokreślone	<input type="checkbox"/>	10 Unit/Szt 5147420
17	164	65	50 W	100-240V AC - 50-60Hz	12V DC	Not defined/ Nieokreślone	<input type="checkbox"/>	10 Unit/Szt 5147520
38	153	60	72 W	100-240V AC - 50-60Hz	12V DC	Not defined/ Nieokreślone	<input type="checkbox"/>	10 Unit/Szt 5008520

Plastic/Plastik

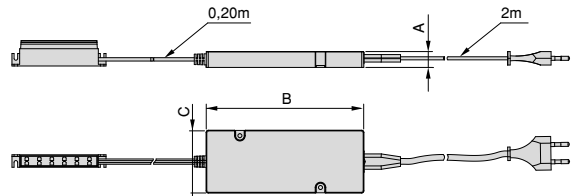
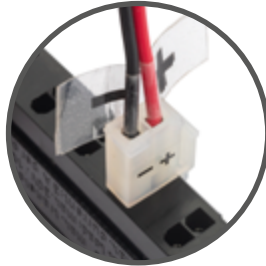

Constant-voltage converter for LED lights (12V DC)
Zasilacz napięcia stałego do opraw LED (12V DC)



A	B	C	Power/Moc	Input	Output	Finishing/Wykończenie	Packaging/Opakowanie	Cod.
18	160	58	100 W	200-240V AC - 50-60Hz	12V DC	Not defined/ Nieokreślone	<input type="checkbox"/>	5 Unit/Szt 5209320
35	205	71	200 W	200-240V AC - 50-60Hz	12V DC	Not defined/ Nieokreślone	<input type="checkbox"/>	5 Unit/Szt 5209420

Aluminium, Steel/Aluminium, Stal

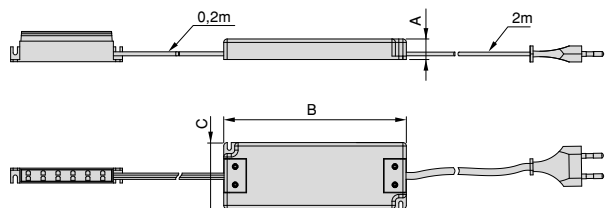

Constant-voltage converter for LED lights, plastic (24V DVC)
Zasilacz napięcia stałego do opraw LED, plastik (24V DVC)

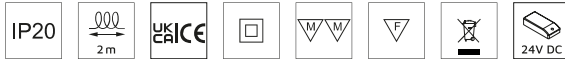

A	B	C	Power/Moc	Input	Output	Finishing/Wykończenie	Packaging/Opakowanie	Cod.
16.2	96	41	15 W	180-240V AC - 50Hz	24V DC	Not defined/ Nieokreślone	10 Unit/Szt	5211220
17	164	65	30 W	100-240V AC - 50-60Hz	24V DC	Not defined/ Nieokreślone	10 Unit/Szt	5147620
17	164	65	50 W	100-240V AC - 50-60Hz	24V DC	Not defined/ Nieokreślone	10 Unit/Szt	5147720

Aluminium, Steel/Aluminium, Stal

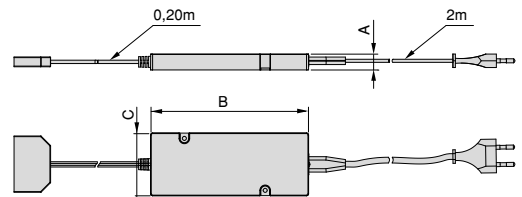
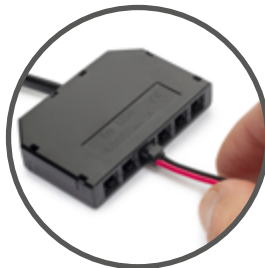

Constant-voltage converter for LED lights (24V DC)
Zasilacz napięcia stałego do opraw LED (24V DC)



A	B	C	Power/Moc	Input	Output	Finishing/Wykończenie	Packaging/Opakowanie	Cod.
18	160	58	100 W	200-240V AC - 50-60Hz	24V DC	Not defined/ Nieokreślone	5 Unit/Szt	5209520

Aluminium, Steel/Aluminium, Stal

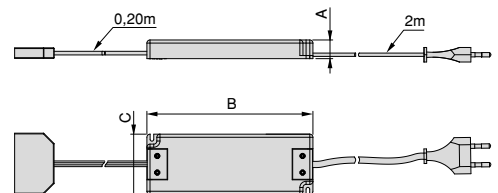

LED sensor Point switch SIMPLE (switch) 240V AC
Czujnik LED Przełącznik (wyłącznik) punktowy SIMPLE 240V AC



Model/Model	Power/Moc	Input	Output	Finishing/Wykończenie	Packaging/Opakowanie	Cod.
SWITCH SIMPLE	Max. 250 W	100-240V AC 50-60Hz	100-240V AC 50-60Hz	Silver painted/Malowane aluminium	10 Unit/Szt	5040525

Plastic/Plastik

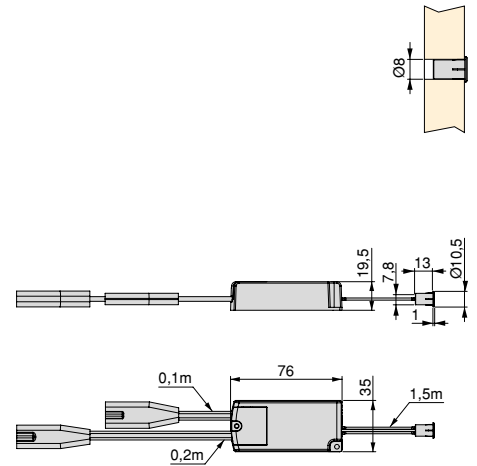
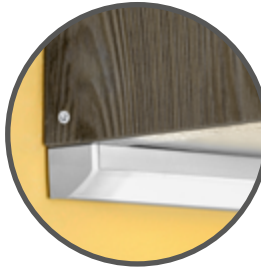
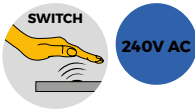

LED sensor Point switch DOUBLE (switch) 240V AC
Czujnik LED Przełącznik (wyłącznik) DOUBLE punktowy 240 V AC



Model/Model	Power/Moc	Input	Output	Finishing/Wykończenie	Packaging/Opakowanie	Cod.
SWITCH DOBLE	Max. 250 W	100-240V AC 50-60Hz	100-240V AC 50-60Hz	Silver painted/Malowane aluminium	10 Unit/Szt	5040625

Plastic/Plastik

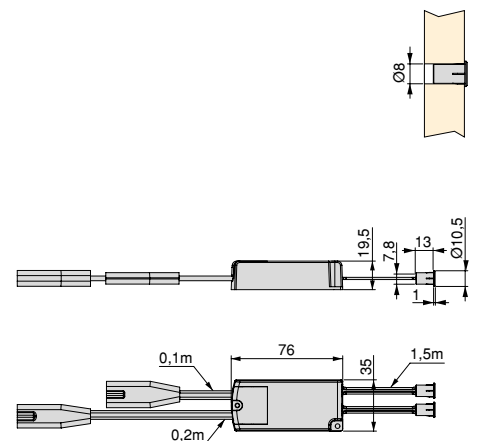
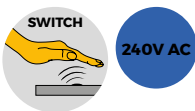

LED sensor Point door SIMPLE (proximity) 240V AC
Czujnik LED Drzwi punktowe PROSTE (zblizeniowe) 240V AC



Model/Model	Power/Moc	Input	Output	Finishing/Wykończenie	Packaging/Opakowanie	Cod.
DOOR SIMPLE	Max. 250 W	100-240V AC 50-60Hz	100-240V AC 50-60Hz	Silver painted/Malowane aluminium	10 Unit/Szt	5040725

Plastic/Plastik

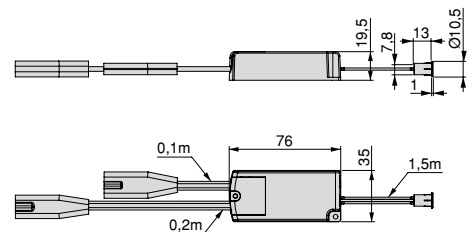
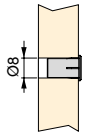
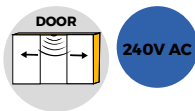

LED sensor Point door DOUBLE (proximity) 240V AC
Czujnik LED Drzwi dwupunktowe (zblizeniowe) 240 V AC



Model/Model	Power/Moc	Input	Output	Finishing/Wykończenie	Packaging/Opakowanie	Cod.
DOOR DOBLE	Max. 250 W	100-240V AC 50-60Hz	100-240V AC 50-60Hz	Silver painted/Malowane aluminium	10 Unit/Szt	5040825

Plastic/Plastik

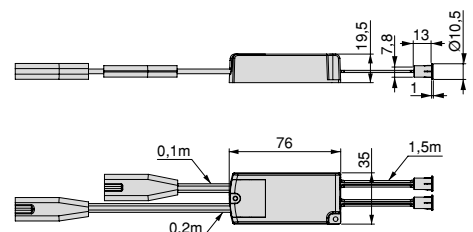
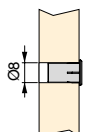

LED sensor Red Eye 4 motion (movement) 240V AC
Czujnik LED Ruch Red Eye 4 (ruch) 240V AC



Model/Model	Power/Moc	Input	Output	Finishing/Wykończenie	Packaging/Opakowanie	Cod.
MOTION SIMPLE	250 W	100-240V AC 50-60Hz	100-240V AC 50-60Hz	Not defined/ Nieokreślone	<input type="checkbox"/>	10 Unit/Szt 7001820

Plastic/Plastik

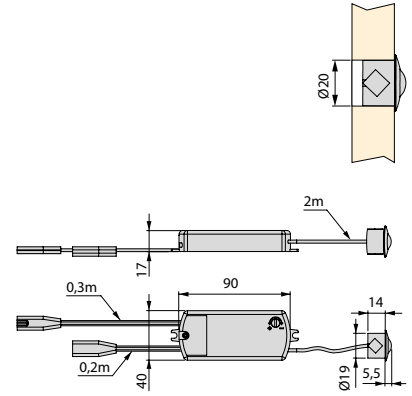
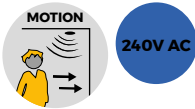

LED sensor Red Eye 5 metal (touch) 240V AC
Czujnik LED Metal (dotykowy) Red Eye 5



Model/Model	Power/Moc	Input	Output	Finishing/Wykończenie	Packaging/Opakowanie	Cod.
METAL SIMPLE	500 W	220-240V AC - 50Hz	220-240V AC 50-60Hz	Not defined/ Nieokreślone	<input type="checkbox"/>	10 Unit/Szt 7001920

Plastic/Plastik

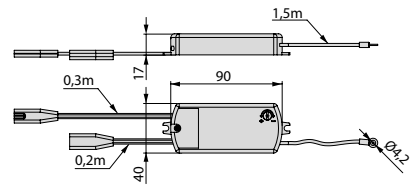
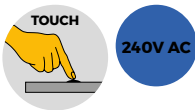

Touch pad and screw
Włącznik/ściemniacz (Włącznik) ukryty czujnik Spirit

Finishing/Wykończenie	Packaging/Opakowanie	Cod.
Chrome plated/Chromowane	10 Unit/Szt	7006011

Steel/Stal

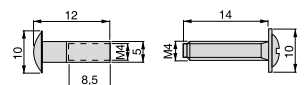

LED sensor Point switch SIMPLE (switch) 12V DC / 24V DC
Czujnik LED Włącznik punktowy (Włącznik)



Model/Model	Power/Moc	Input	Output	Finishing/Wykończenie	Packaging/Opakowanie	Cod.
SWITCH SIMPLE	36 W (12V DC) - 72 W (24V DC)	12V DC - 24V DC	12V DC - 24V DC	Silver painted/Malowane aluminium	6 Unit/Szt	5022925

Plastic/Plastik

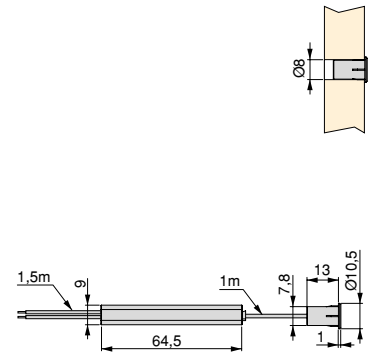
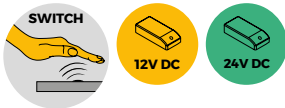

LED sensor Point switch DOUBLE (switch) 12V DC / 24V DC
Czujnik LED Włącznik punktowy (Włącznik)



Model/Model	Power/Moc	Input	Output	Finishing/Wykończenie	Packaging/Opakowanie	Cod.
SWITCH DOBLE	36 W (12V DC) - 72 W (24V DC)	12V DC - 24V DC	12V DC - 24V DC	Silver painted/Malowane aluminium	6 Unit/Szt	5023025

Plastic/Plastik

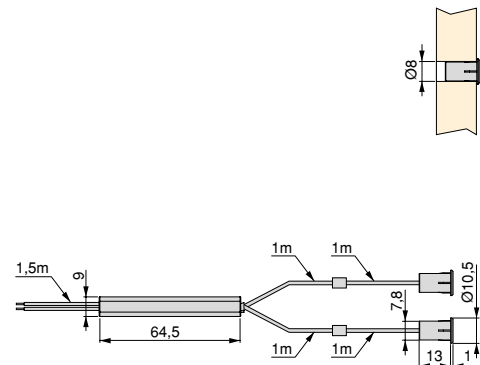
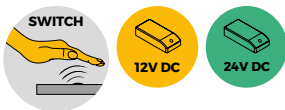

LED sensor Point door (proximity) 12V DC / 24V DC
Czujnik LED Drzwi Point (zbliżeniowy)



Model/Model	Power/Moc	Input	Output	Finishing/Wykończenie	Packaging/Opakowanie	Cod.
DOOR SIMPLE	36 W (12V DC) - 72 W (24V DC)	12V DC - 24V DC	12V DC - 24V DC	Silver painted/Malowane aluminium	6 Unit/Szt	5023225

Plastic/Plastik

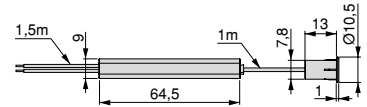
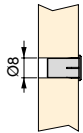
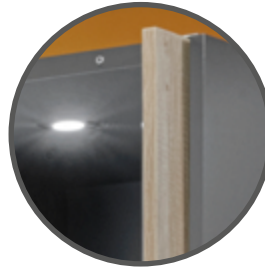
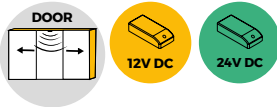

LED sensor Point motion (movement) 12V DC / 24V DC
Czujnik LED Ruch Point



Model/Model	Power/Moc	Input	Output	Finishing/Wykończenie	Packaging/Opakowanie	Cod.
MOTION SIMPLE	36 W (12V DC) - 72 W (24V DC)	12V DC - 24V DC	12V DC - 24V DC	Not defined/ Nieokreślone	6 Unit/Szt	5023120

Plastic/Plastik

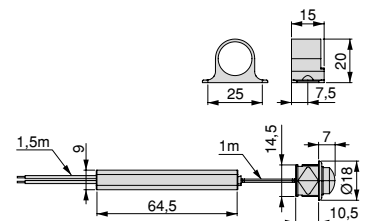
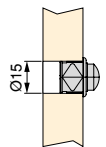
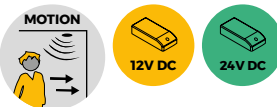

LED sensor Dot Ø16 switch/dimmer (switch) 12V DC / 24V DC
Czujnik LED Włącznik/ściemniacz Dot Ø16 (Włącznik)



Model/Model	Power/Moc	Input	Output	Finishing/Wykończenie	Packaging/Opakowanie	Cod.
SWITCH DIMMER SIMPLE	36 W (12V DC) - 72 W (24V DC)	12V DC - 24V DC	12V DC - 24V DC	Silver painted/Malowane aluminium	6 Unit/Szt	5022825

Plastic/Plastik

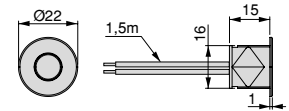
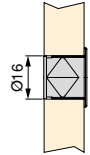
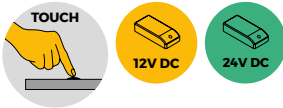

LED sensor Dot Ø12 switch/dimmer (switch) 12V DC / 24V DC
Czujnik LED Włącznik/ściemniacz Dot Ø12 (Włącznik)



Model/Model	Power/Moc	Input	Output	Finishing/Wykończenie	Packaging/Opakowanie	Cod.
SWITCH DIMMER SIMPLE	36 W (12V DC) - 72 W (24V DC)	12V DC - 24V DC	12V DC - 24V DC	Silver painted/Malowane aluminium	6 Unit/Szt	5218425

Plastic/Plastik

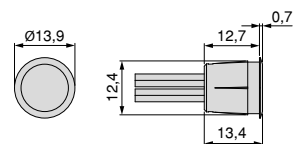
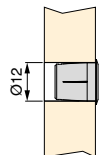
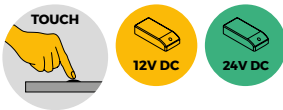

LED sensor Micron switch/dimmer (switch) 12V DC / 24V DC
Czujnik LED Włącznik/ściemniacz Micron (Włącznik)

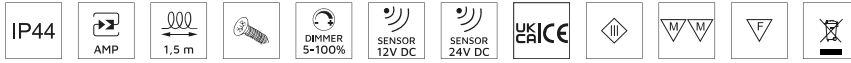

Model/Model	Power/Moc	Input	Output	Finishing/Wykończenie	Packaging/Opakowanie	Cod.
SWITCH DIMMER SIMPLE	24 W (12V DC) - 48 W (24V DC)	12V DC - 24V DC	12V DC - 24V DC	Silver painted/Ma- lowane aluminium	6 Unit/Szt	5053125

Plastic/Plastik

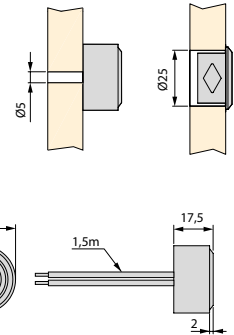
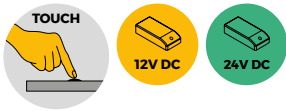

LED sensor Spirit switch/dimmer (switch) hidden sensor 12V DC
Czujnik LED Włącznik/ściemniacz (Włącznik) ukryty czujnik Spirit



Model/Model	Power/Moc	Input	Output	Finishing/Wykończenie	Packaging/Opakowanie	Cod.
SWITCH DIMMER SIMPLE	Max. 80 W	12V DC	12V DC	Black plastic/Czarny plastik	6 Unit/Szt	5022617

Plastic/Plastik

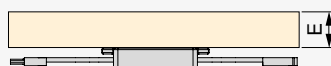
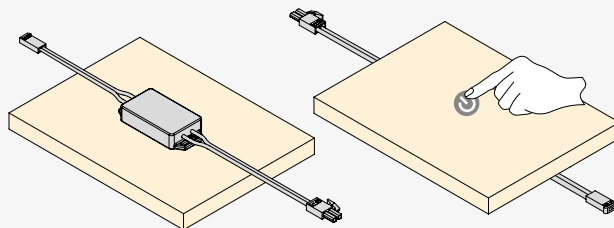
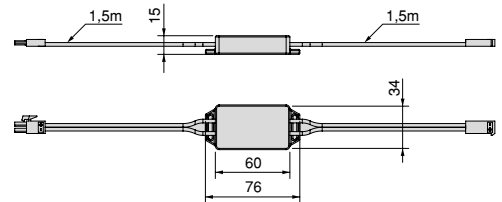
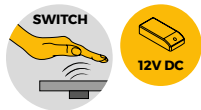

Hidden sensor that penetrates materials of up to 32 mm thick.
Not compatible with mirrors and metals.

- E < 32 mm Wood.
- E < 22 mm Plastic.
- E < 20 mm Stone.
- E < 12 mm Glass.

Ukryty czujnik przenikający materiały o grubości do 32 mm.
Niekompatybilne z lustrami.

- E < 32 mm Drewno.
- E < 22 mm Plastik.
- E < 20 mm Kamień.
- E < 12 mm Kamień.

RGB Remote Controller for illumination
Pilot RGB do oświetlenia



Finishing/Wykończenie	Packaging/Opakowanie	Cod.
Not defined/Nieokreślone <input type="checkbox"/>	1 Unit/Szt	5205520

Plastic/Plastik

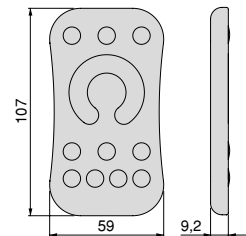

Dimmer Remote Controller for illumination
Pilot Dimmer do oświetlenia



Finishing/Wykończenie	Packaging/Opakowanie	Cod.
Not defined/Nieokreślone <input type="checkbox"/>	1 Unit/Szt	5205720

Plastic/Plastik

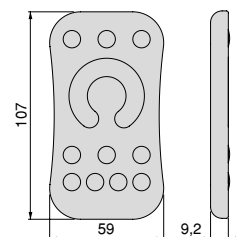

LED Control for lighting
Sterownik LED do oświetlenia



Finishing/Wykończenie	Packaging/Opakowanie	Cod.
Not defined/Nieokreślone <input type="checkbox"/>	1 Unit/Szt	5205920

Plastic/Plastik

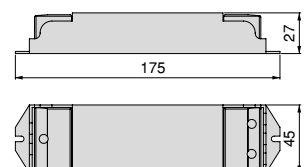

Receptor of LED sensor Wirly 12V DC / 24V DC
Odbiornik czujnika LED Wirly 12V DC / 24V DC

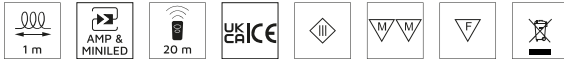

Power/Moc	Input	Output	Finishing/Wykończenie	Packaging/Opakowanie	Cod.
36 W (12V DC) - 72 W (24V DC)	12V DC - 24V DC	12V DC - 24V DC	Not defined/Nieokreślone	□	5215020

Plastic/Plastik

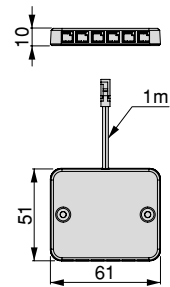
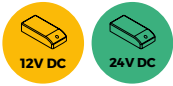

One transmitter can be linked to up to 8 receivers and one receiver can be linked to up to 10 different transmitters.

Jeden nadajnik może być połączony z maksymalnie 8 odbiornikami, a jeden odbiornik może być połączony z maksymalnie 10 różnymi nadajnikami.

The Wirly detection system consists of a receiver and a signal transmitter that allows luminaires to be switched on and off from any point via radio frequency.

System detekcji Wirly składa się z odbiornika i nadajnika sygnału, który umożliwia włączanie i wyłączenie opraw oświetleniowych z dowolnego miejsca za pośrednictwem częstotliwości radiowej.

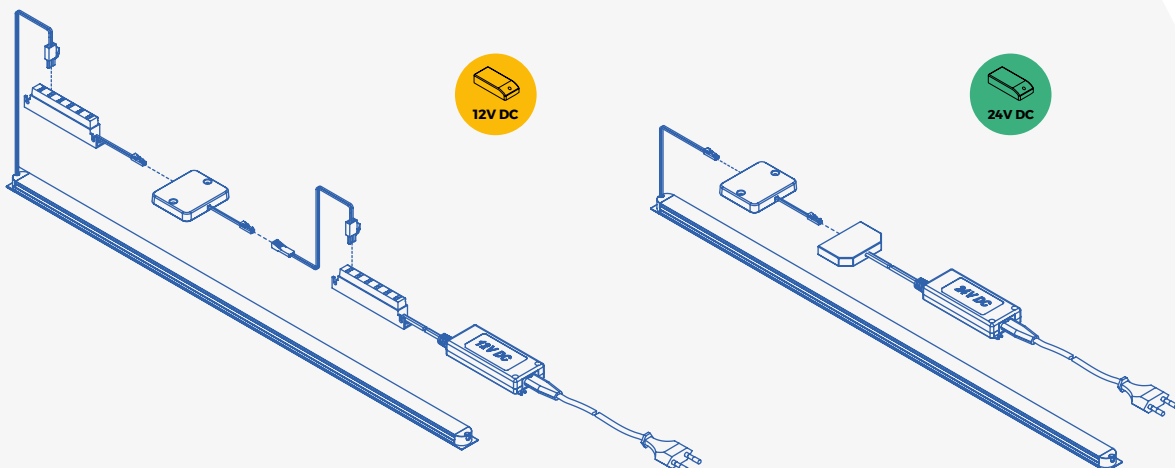

Transmitter for LED sensor Wirly switch/dimmer (switch) 12V DC / 24V DC
Nadajnik zbliżeniowy LED Wirly switch/dimmer (przełącznik) 12V DC / 24V DC



Model/Model	Finishing/Wykończenie	Packaging/Opakowanie	Cod.
SWITCH DIMMER SIMPLE	Not defined/Nieokreślone <input type="checkbox"/>	10 Unit/Szt	5215120

Plastic/Plastik

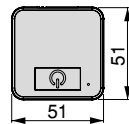
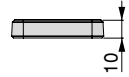

Transmitter for LED sensor Wirly switch/motion (movement) 12V DC / 24V DC
Nadajnik zbliżeniowy LED Wirly switch/motion (ruch) 12V DC / 24V DC



Model/Model	Finishing/Wykończenie	Packaging/Opakowanie	Cod.
MOTION SIMPLE	Not defined/Nieokreślone <input type="checkbox"/>	10 Unit/Szt	5215220

Plastic/Plastik

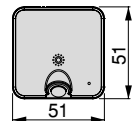
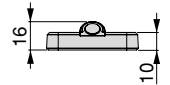

Transmitter for LED sensor Wirly door (proximity) 12V DC / 24V DC
Nadajnik zbliżeniowy LED Wirly door (zbliżeniowy) 12V DC / 24V DC



Model/Model	Finishing/Wykończenie	Packaging/Opakowanie	Cod.
DOOR SIMPLE / DOOR DOBLE / PROXIMITY DIMMER	Not defined/Nieokreślone <input type="checkbox"/>	10 Unit/Szt	5215320

Plastic/Plastik

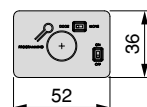
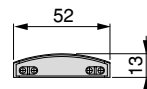
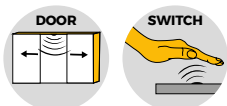

AMP extension cable (12V DC)
Przedłużacz AMP (12V DC)



Longitude/Długość	Power/Moc	Finishing/Wykończenie	Packaging/Opakowanie	Cod.
2 m	Max. 60 W	Black plastic/Czarny plastik	25 Unit/Szt	9269817

Plastic/Plastik

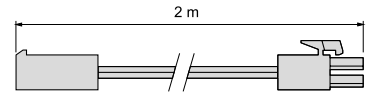

12V AMP distribution cable
Kabel rozdzielczy 12V AMP

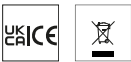

Longitude/Długość	Finishing/Wykończenie	Packaging/Opakowanie	Cod.
0.25 m	White plastic/Biały plastik	10 Unit/Szt	7065715

Plastic/Plastik

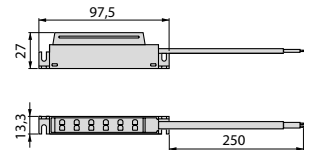

AMP to Miniled adaptor set for sensors (12V DC) (24V DC)
Zestaw adapterów AMP do MiniLED do czujników (12V DC) (24V DC)



Finishing/Wykończenie	Packaging/Opakowanie	Cod.
Not defined/Nieokreślone	10 Unit/Szt	5205020

Plastic/Plastik

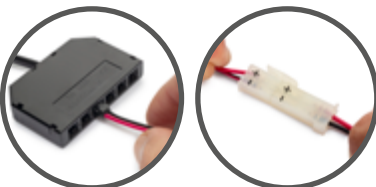
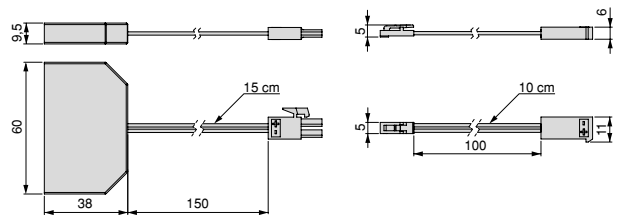

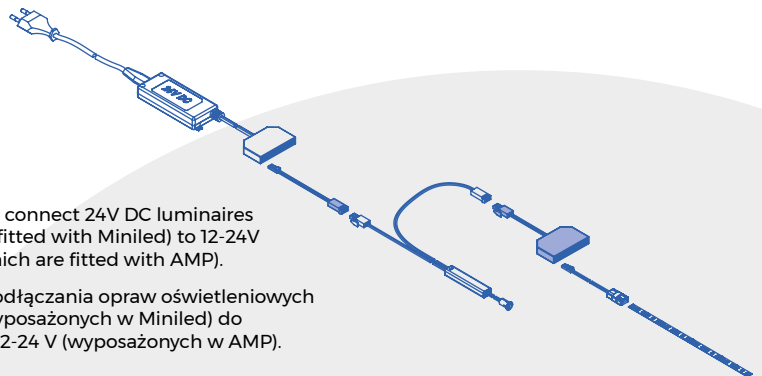

It is used to connect 24V DC luminaires (which are fitted with Miniled) to 12-24V sensors (which are fitted with AMP).

Służy do podłączenia opraw oświetleniowych 24 V DC (wyposażonych w Miniled) do czujników 12-24 V (wyposażonych w AMP).



Wardrobe door switch
Przełącznik do drzwi szafy



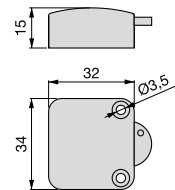
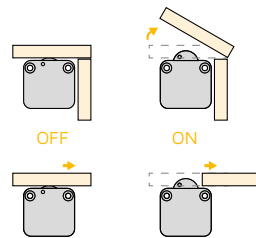

Finishing/Wykończenie	Packaging/Opakowanie	Cod.
White plastic/Biały plastik 	10 Unit/Szt	9642415
Black plastic/Czarny plastik 	10 Unit/Szt	9642417

Plastic/Plastik



Switch for embedding D21x21
Włącznik, montaż wpuszczany D21x21



Finishing/Wykończenie	Packaging/Opakowanie	Cod.
White plastic/Biały plastik 	10 Unit/Szt	9640215
Black plastic/Czarny plastik 	10 Unit/Szt	9640217
Grey plastic/Szary plastik 	10 Unit/Szt	9640221

Plastic/Plastik

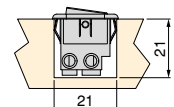
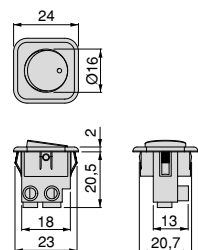

Chargers Ładowarki

The wireless chargers are designed to charge your tablet or smartphone in a discreet and accessible way thanks to their complete integration in home and office furniture.

Bezprzewodowe ładowarki zostały zaprojektowane do ładowania tabletu lub smartfona w dyskretny i łatwo dostępny sposób, dzięki pełnej integracji z meblami domowymi i biurowymi.



They allow wireless charging using Qi wireless technology (V1.1) only for devices compatible with this protocol.

Umożliwiają bezprzewodowe ładowanie za pomocą technologii bezprzewodowej Qi (V1.1) tylko dla urządzeń kompatybilnych z tym protokołem.



This model also allows the charging of electronic devices via USB connection.

Model ten umożliwia również ładowanie urządzeń elektronicznych przez złącze USB.



Airtop 2 wireless hidden charger for mobiles (Ø60mm)
Bezprzewodowa ładowarka ukryta do telefonów komórkowych Airtop (Ø60mm)



Input	Output	Finishing/Wykończenie	Packaging/Opakowanie	Cod.
100-240V AC - 50/60Hz	5V DC 2A (Qi-10W)	Black plastic/Czarny plastik	1 Unit/Szt	5049317

Plastic/Plastik

AC 230V
50Hz

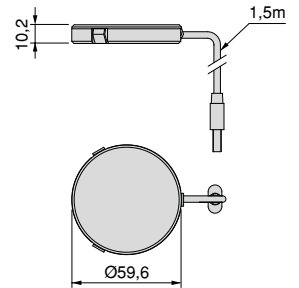
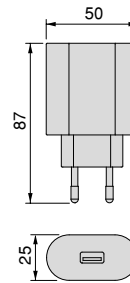
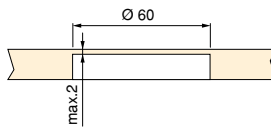

Airtop 2 USB-A wireless charger of surface for mobiles (Ø60mm)
Bezprzewodowa ładowarka Surface Airtop 2 USB-A (Ø60 mm)



Input	Output	Finishing/Wykończenie	Packaging/Opakowanie	Cod.
100-240V AC - 50/60Hz	5V DC / 2.1A (USB-10W/Qi-10W)	Black plastic/Czarny plastik	1 Unit/Szt	5049217

Plastic/Plastik

AC 230V
50Hz

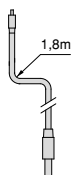
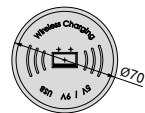
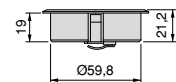
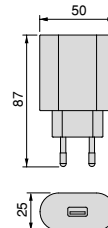
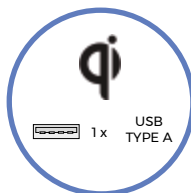
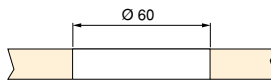

Connectors Złącza

The multi-connectors for kitchen, office and home are an essential accessory, because they make life easier and add functionality to your furniture.

Multizłącza do kuchni, biura i domu są niezbędnym akcesorium, ponieważ ułatwiają życie i dodają funkcjonalności meblom.



Thanks to their total integration in the furniture, the connectors are fully accessible at all times.

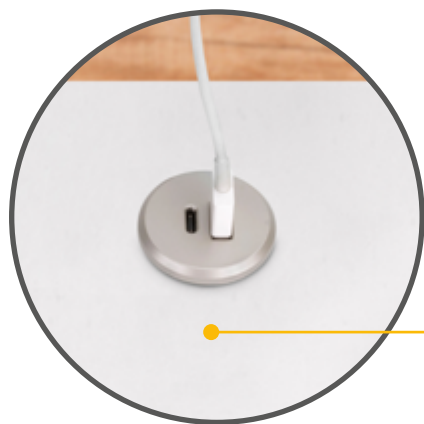

Dzięki całkowitej integracji z meblami, złącza są w pełni dostępne przez cały czas.



They are designed to charge electronic devices such as tablets or mobile phones easily and discreetly.

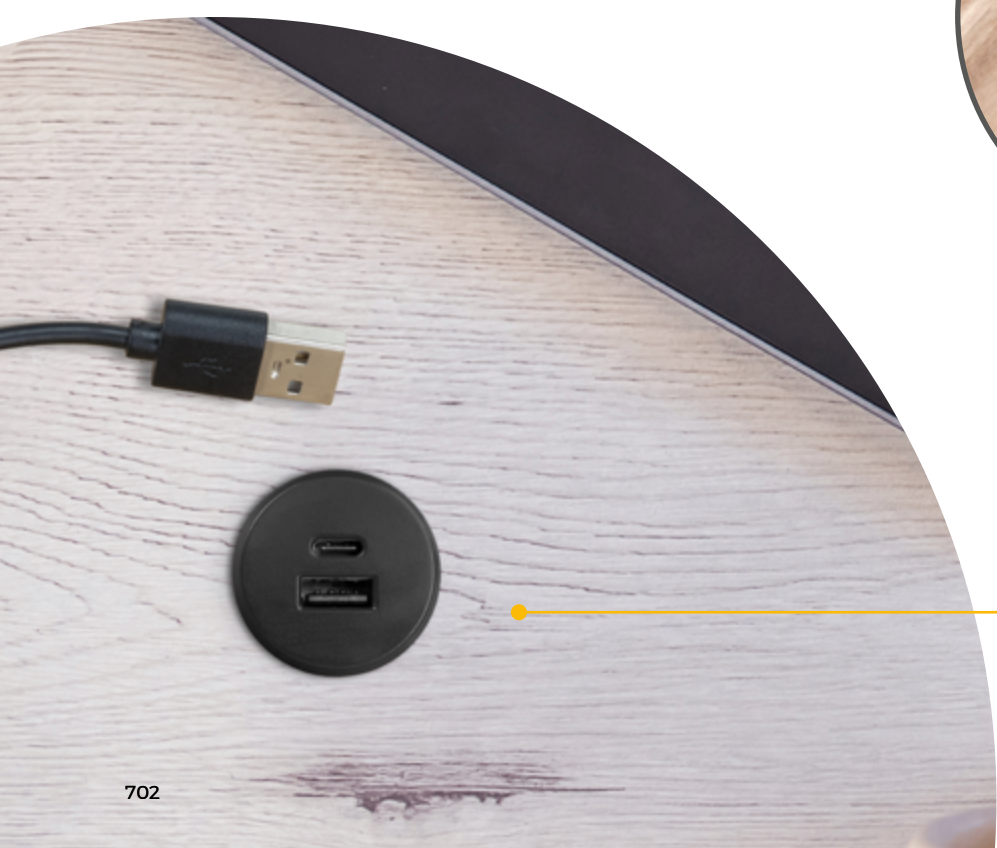

Zaprojektowano je z myślą o łatwym i dyskretnym ładowaniu urządzeń elektronicznych, takich jak tablety czy telefony komórkowe.

Cargador Linky USB A+C charger (81x12mm)
Carregador USB A+C Linky złącze (81x12mm)

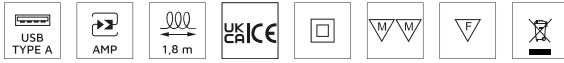

Input	Output	Finishing/Wykończenie	Packaging/Opakowanie	Cod.
100-240V AC - 50/60Hz	USB A - DC 5V-2A (10W) USB C - DC 5V-2A (10W)	Black plastic/Czarny plastik	1 Unit/Szt	5049417

Plastic/Plastik

**AC 230V
50Hz**

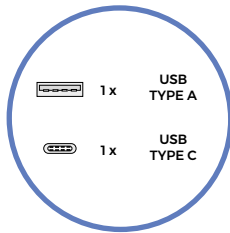
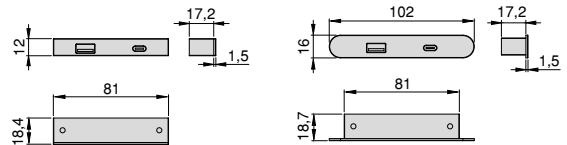

Cargador Plugy USB A+C charger Ø37 (Ø25mm)
Carregador USB A+C Plugy złącze okrągłe Ø37 (Ø25mm)



Description/Opis	Input	Output	Finishing/Wykończenie	Packaging/Opakowanie	Cod.
Ø37	12VDC-3A (30W) / 24VDC-1.5A (36W)	USB-A 18W: 5V-3A / 10V-2.22A / 12V-1.67A USB-C 20W: 5V-3A / 9V-2.22A / 12V-1.67A	Black painted/ Malowane na czarno	6 Unit/Szt	5221114
Ø37	12VDC-3A (30W) / 24VDC-1.5A (36W)	USB-A 18W: 5V-3A / 10V-2.22A / 12V-1.67A USB-C 20W: 5V-3A / 9V-2.22A / 12V-1.67A	Silver painted/ Malowane aluminium	6 Unit/Szt	5221125

Plastic/Plastik

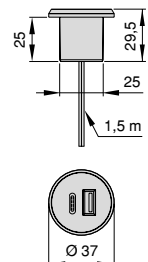
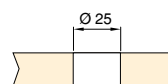
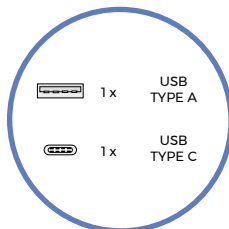

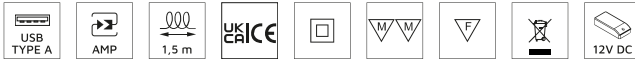

CargadorUSB Plugy Ø37 round charger (Ø25mm)
Carregador USB Plugy złącze okrągłe Ø37 (Ø25mm)

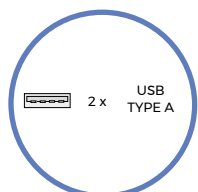
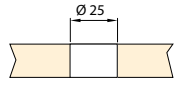
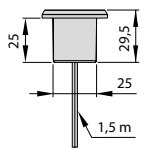

Description/Opis	Input	Output	Finishing/Wykończenie	Packaging/Opakowanie	Cod.
Ø37	12V DC	5V DC	Black painted/Malowane na czarno	6 Unit/Szt	5009014
Ø37	12V DC	5V DC	Silver painted/Malowane aluminium	6 Unit/Szt	5009025

Plastic/Plastik



	Input	Output
	30 W 12V DC (2,50A)	5V DC - 3,40A MAX. (1 x 3,40A) (2 x 1,70A)
	15 W 12V DC (1,25A)	5V DC - 1,70A MAX. (1 x 1,70A) (2 x 0,85A)

CargadorPlugy round charger with 2 USB ports for embedding into furniture (Ø25mm)
Carregador Ładowarka 2x USB wpuszczana w płytę meblową, Plugy (Ø25mm)

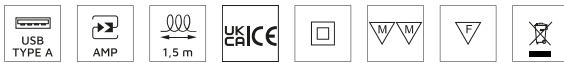

Description/Opis	Finishing/Wykończenie	Packaging/Opakowanie	Cod.
Ø37	Black painted/Malowane na czarno	1 KIT/Zestaw	5070614
Ø37	Silver painted/Malowane aluminium	1 KIT/Zestaw	5070625

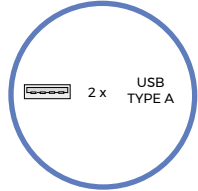
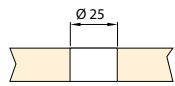
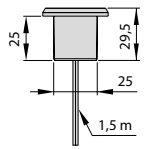
Plastic/Plastik

KITS

Connector One for embedding into furniture (Ø54mm)
Conector One montaż wpuszczany wewnątrz mebla (Ø54mm)

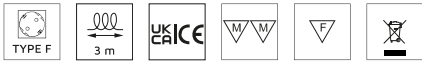

Finishing/Wykończenie	Packaging/Opakowanie	Cod.
Black painted/Malowane na czarno	1 Unit/Szt	5048314

Plastic/Plastik

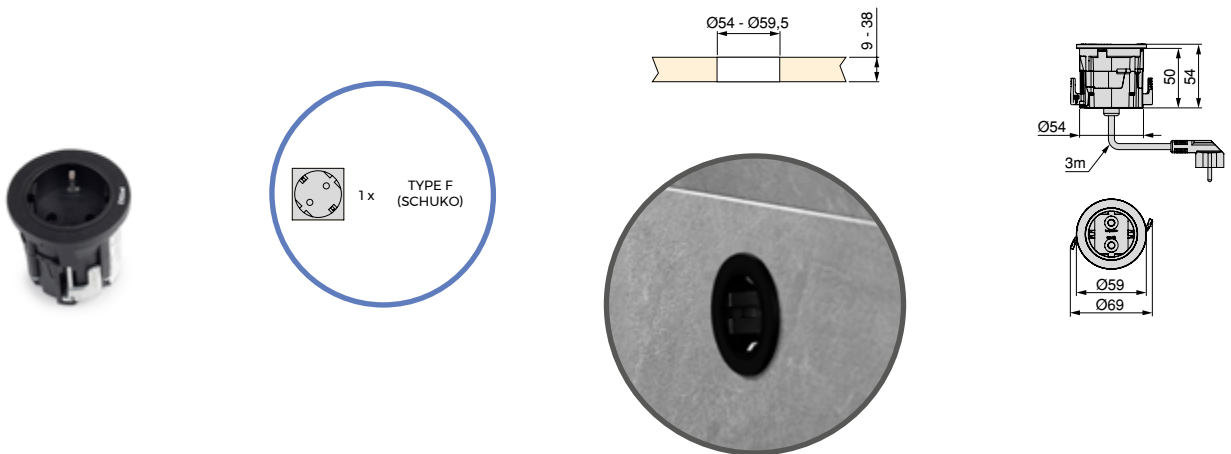

Vertikal Flat 60 plug connector with sliding cover (Ø60mm)
Listwa zasilająca z gździadkiem Flat 60 z przesuwającą pokrywą (Ø60mm)



Power/Moc	Finishing/Wykończenie	Packaging/Opakowanie	Cod.
USB-A - DC 5V-2.4A (12W)	Stainless steel/Stal nierdzewna	1 Unit/Szt	5048065

Plastic, Steel/Plastik, Stal

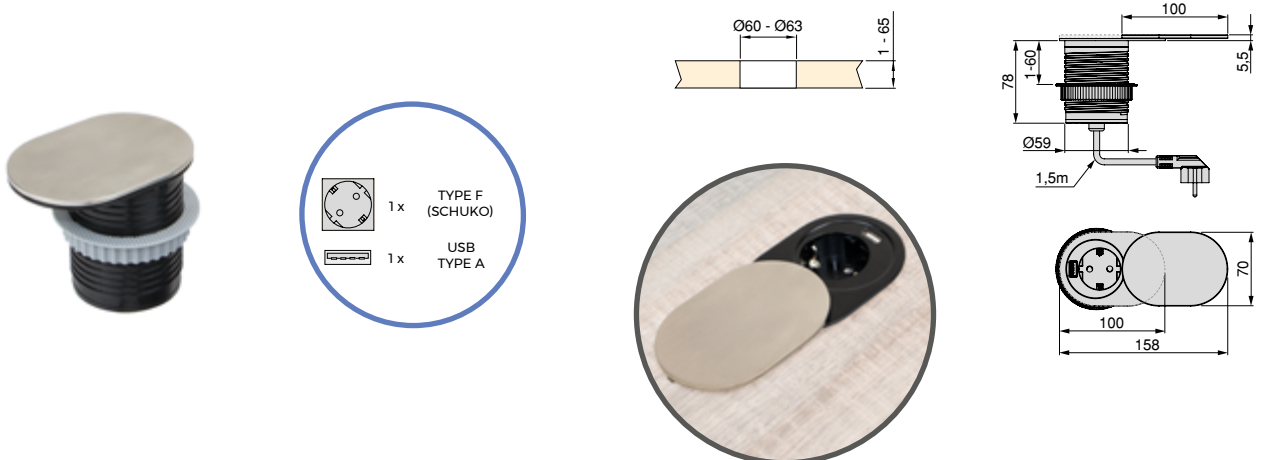

Connectors Złącza

Connector and grommet for recessing in office and home furniture, with integrated child safety.

Złącze i przelotka do wbudowania w meble biurowe i domowe, ze zintegrowanym zabezpieczeniem przed dziećmi.



They are designed to charge electronic devices such as tablets or mobile phones easily and discreetly.

Przeznaczone są do łatwego i dyskretnego ładowania urządzeń elektronicznych, takich jak tablety lub telefony komórkowe.

Circle 80 plug connector and grommet (Ø80mm) Złącze i przelotka Circle 80 (Ø80mm)



Power/Moc	Finishing/Wykończenie	Packaging/Opakowanie	Cod.
USB A - DC 5V-2.1A (10.5W) - USB C - DC 5V-2.1A (10.5W)	Black painted/Malowane na czarno	1 Unit/Szt	5048414

Plastic/Plastik

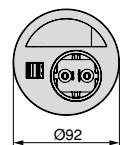
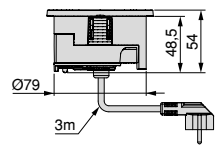
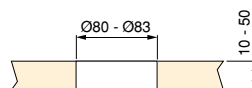
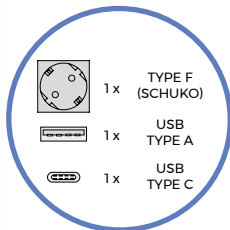

Vertikal Push 60 plug connector (Ø60mm)
Listwa zasilająca z gniaздkami Vertikal Push 60 (Ø60mm)



Power/Moc	Finishing/Wykończenie	Packaging/Opakowanie	Cod.
USB A - DC 5V-2.4A (12W)	Stainless steel/Stal nierdzewna	1 Unit/Szt	5048165

Plastic, Steel/Plastik, Stal

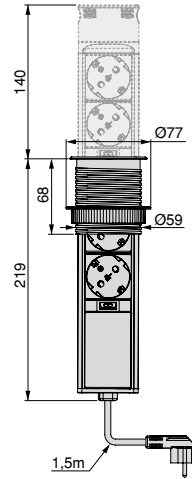
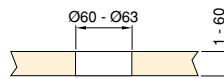
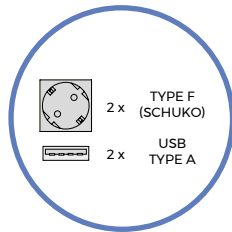

Vertikal retractable multi-plug connector (Ø60mm)
Gniazdowa listwa zasilająca wysuwana Vertikal (Ø60mm)



Description/Opis	Power/Moc	Finishing/Wykończenie	Packaging/Opakowanie	Cod.
3 plugs, 2 USB A connectors and 1 USB C connector/3 wtyczki, 2 złącza USB A i 1 złącze USB C	USB A - DC 5V-3A / 9V-2A / 12V-1.5A - USB C - DC 5V-3A / 9V-2.22A / 12V-1.67A	Silver painted/Malowane aluminium	1 Unit/Szt	5014425
3 plugs and 2 USB connectors/3 wtyczki i 2 złącza USB	USB A - DC 5V-2A (10W)	White painted/Malowane na biało	1 Unit/Szt	5009912
3 plugs and 2 USB connectors/3 wtyczki i 2 złącza USB	USB A - DC 5V-2A (10W)	Silver painted/Malowane aluminium	1 Unit/Szt	5009925
3 plugs and 2 USB connectors/3 wtyczki i 2 złącza USB	USB A - DC 5V-2A (10W)	Black painted/Malowane na czarno	1 Unit/Szt	5009914

Aluminium, Plastic/Aluminium, Plastik

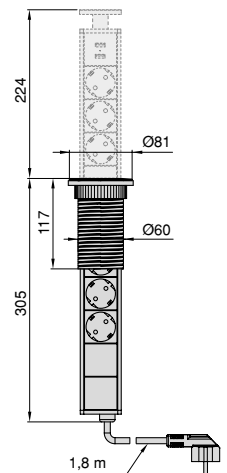
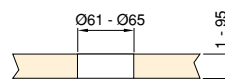
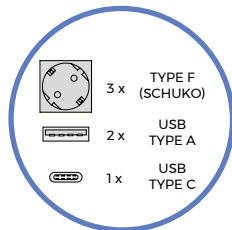

Port USB retractable multi-plug connector (Ø100mm)
Gniazdowa listwa zasilająca wysuwana Port USB (Ø100mm)



Power/Moc	Finishing/Wykończenie	Packaging/Opakowanie	Cod.
USB A - DC 5V-2.1A (10.5W)	Matt anodized/Anodowany mat	1 Unit/Szt	5048762

Aluminium, Plastic/Aluminium, Plastik

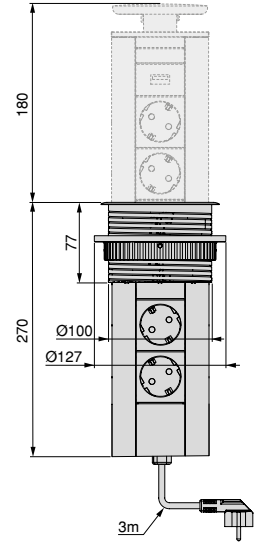
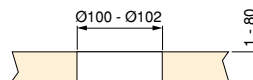
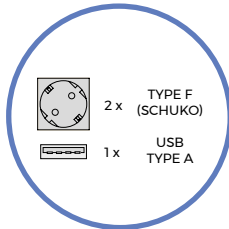

Vertikal Push 100 plug connector (Ø100mm)
Listwa zasilająca z gniaздkami Vertikal Push 100 (Ø100mm)



Power/Moc	Finishing/Wykończenie	Packaging/Opakowanie	Cod.
USB A - DC 5V-2.4A (12W)	Black painted/Malowane na czarno	1 Unit/Szt	5048214

Plastic, Steel/Plastik, Stal

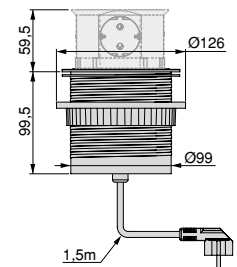
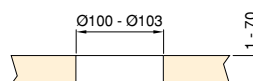
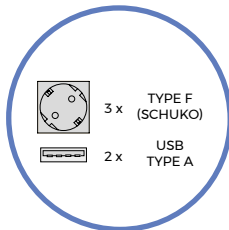

Atom 14 Multi-plug connector for desk (130x115mm)
Wielozłącze Atom 14 na biurko (130x115mm)



Power/Moc	Finishing/Wykończenie	Packaging/Opakowanie	Cod.
USB A - DC 5V-2.1A (10.5W)	Black painted/Malowane na czarno	1 Unit/Szt	5029714
USB A - DC 5V-2.1A (10.5W)	Silver painted/Malowane aluminium	1 Unit/Szt	5029725

Aluminium, Plastic, Steel/Aluminium, Plastik, Stal

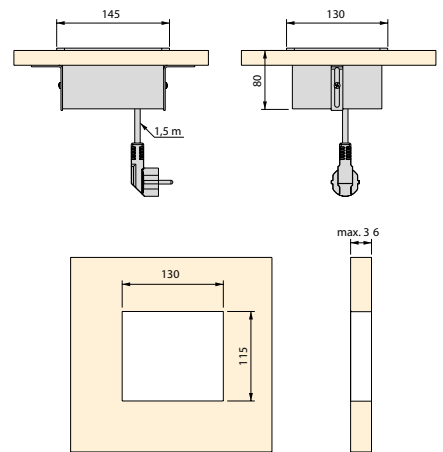
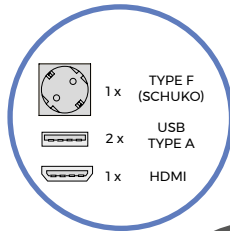

Surface-mounted socket V Dock for furniture
Listwa zasilająca z gniazdkami V Dock do mebli



Finishing/Wykończenie	Packaging/Opakowanie	Cod.
Matt anodized/Anodyzowany mat	1 Unit/Szt	5048862

Aluminium, Plastic/Aluminium, Plastik

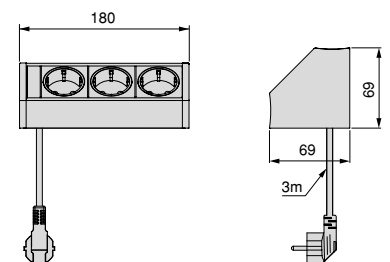
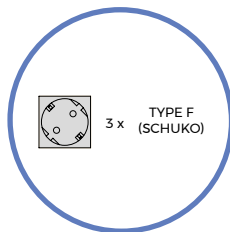

Connectors Złącza

Multi-socket socket with a sleek stainless steel finish that allows for complete built-in integration into kitchen, office and home furniture.

Gniazdo wielofunkcyjne z eleganckim wykończeniem ze stali nierdzewnej, które pozwala na pełną integrację z meblami kuchennymi, biurowymi i domowymi.



Its innovative design keeps sockets concealed when not in use and with a light touch it swivels to access sockets.

Jego innowacyjna konstrukcja sprawia, że gniazda są ukryte, gdy nie są używane, a za pomocą lekkiego dotyku obraca się, aby uzyskać dostęp do gniazd.

Backflip multi-plug connector for desk (215x88mm)

Wielozłącze Backflip na biurko (215x88mm)



Power/Moc	Finishing/Wykończenie	Packaging/Opakowanie	Cod.
USB A - DC 5V-2.1A (10.5W)	Stainless steel/Stal nierdzewna	1 Unit/Szt	5048565

Plastic, Steel/Plastik, Stal

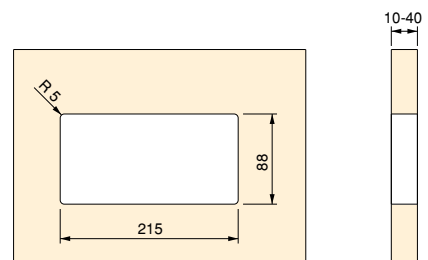
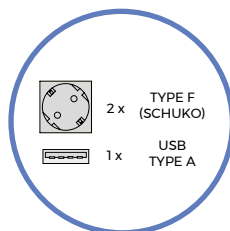
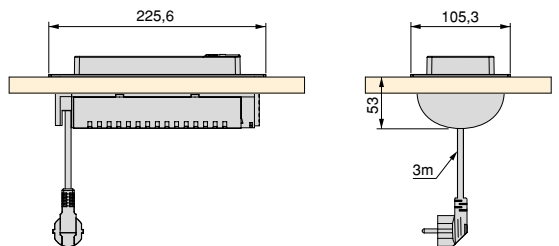

Atom 26 Multi-plug connector for desk (225x111mm)
Wielozłącze Atom 26 na biurko (225x111mm)

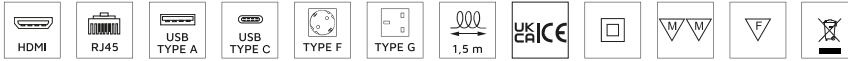

Power/Moc	Finishing/Wykończenie	Packaging/Opakowanie	Cod.
USB A - DC 5V-3A / 9V-2A / 12V-1.5A - USB C - DC 5V-3A / 9V-2A / 12V-1.5A	Black painted/Malowane na czarno	1 Unit/Szt	5039914
USB A - DC 5V-3A / 9V-2A / 12V-1.5A - USB C - DC 5V-3A / 9V-2A / 12V-1.5A	White painted/Malowane na biało	1 Unit/Szt	5039912
USB A - DC 5V-3A / 9V-2A / 12V-1.5A - USB C - DC 5V-3A / 9V-2A / 12V-1.5A	Silver painted/Malowane aluminium	1 Unit/Szt	5039925

Plastic, Steel, Zamak/Plastik, Stal, Znal

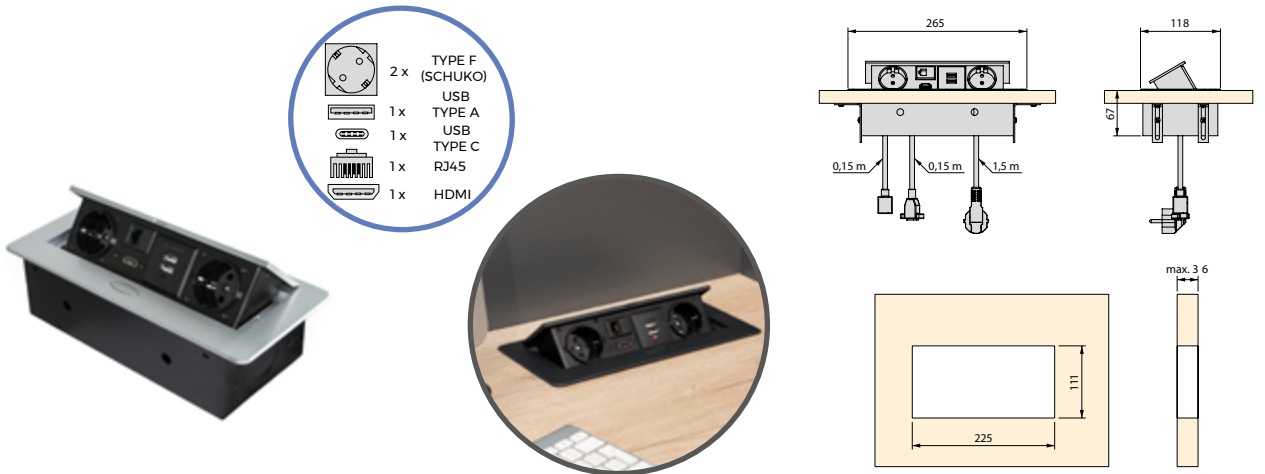

Atom 26 Lite Multi-plug connector for desk (225x111mm)
Wielozłącze Atom 26 Lite na biurko (225x111mm)



Power/Moc	Finishing/Wykończenie	Packaging/Opakowanie	Cod.
USB A - DC 5V-2.1A (10.5W) - USB C - DC 5V-2.1A (10.5W)	White painted/Malowane na biało	1 Unit/Szt	5039812
USB A - DC 5V-2.1A (10.5W) - USB C - DC 5V-2.1A (10.5W)	Black painted/Malowane na czarno	1 Unit/Szt	5039814
USB A - DC 5V-2.1A (10.5W) - USB C - DC 5V-2.1A (10.5W)	Silver painted/Malowane aluminium	1 Unit/Szt	5039825

Plastic, Steel, Zamak/Plastik, Stal, Znal

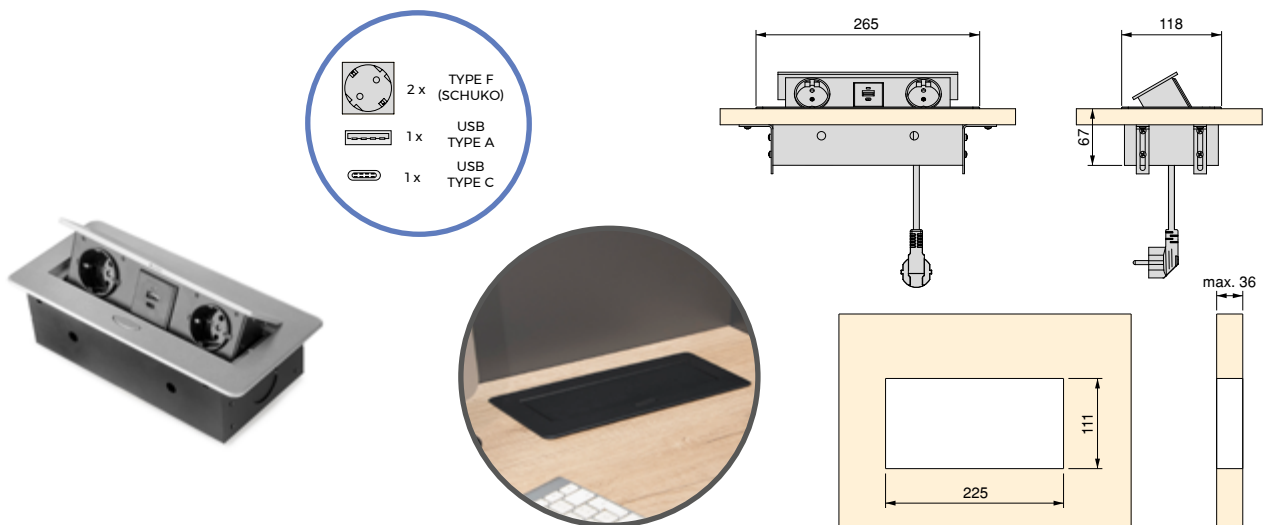

Accesorios de oficina Akcesoria biurowe

To create comfortable workspaces you need some essential office accessories to add functionality to your furniture.

Aby stworzyć wygodne miejsce pracy, potrzebujesz kilku niezbędnych akcesoriów biurowych, które dodadzą funkcjonalności Twoim meblom.



By simply machining, you will always have your cables organised thanks to our range of cable grommets.

Dzięki naszej gamie przepustów kablowych kable będą zawsze uporządkowane.







The cable grommets are designed to keep cables organised under the office desk and prevent them from getting tangled.

Przepusty kablowe zostały zaprojektowane w celu uporządkowania kabli pod biurkiem i zapobiegania ich splątaniu.







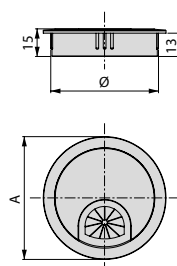
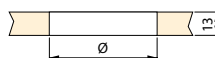

Circum round cable grommet (Ø60mm, Ø80mm)
Przepust kablowy okrągły Circum (Ø60mm, Ø80mm)

A	Diametre/Średnica	Finishing/Wykończenie	Packaging/Opakowanie	Cod.
68,5	60	Chrome plated/Chromowane 	8 Unit/Szt	5006711
90	80	Chrome plated/Chromowane 	7 Unit/Szt	5022511
68,5	60	Matt chrome plated/Chromowane matowe 	8 Unit/Szt	5006764
90	80	Matt chrome plated/Chromowane matowe 	7 Unit/Szt	5022564

Zamak/Znal





Circular cable organizer (Ø60mm, Ø80mm)
Kołowy organizator kabli (Ø60mm, Ø80mm)

A	B	Diametre/Średnica	Finishing/Wykończenie	Packaging/Opakowanie	Cod.
71	14	60	White plastic/Biały plastik 	100 Unit/Szt	5123815
95	20	80	White plastic/Biały plastik 	100 Unit/Szt	5123915
71	14	60	Black plastic/Czarny plastik 	100 Unit/Szt	5123817
95	20	80	Black plastic/Czarny plastik 	100 Unit/Szt	5123917
71	14	60	Grey plastic/Szary plastik 	100 Unit/Szt	5123821
95	20	80	Grey plastic/Szary plastik 	100 Unit/Szt	5123921

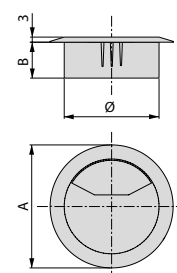
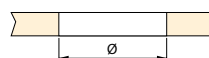
Plastic/Plastik





Quadrum desk cable grommet, rectangular (159x80mm, 269x80mm)
Przepust kablowy stołowy Quadrum, prostokątny (159x80mm, 269x80mm)

A	B	Finishing/Wykończenie	Packaging/Opakowanie	Cod.
159	147	Matt anodized/Anodyzowany mat 	5 Unit/Szt	5010062
269	257	Matt anodized/Anodyzowany mat 	5 Unit/Szt	5012462

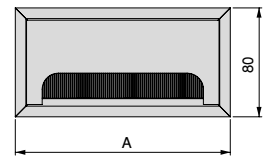
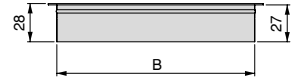
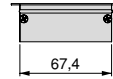
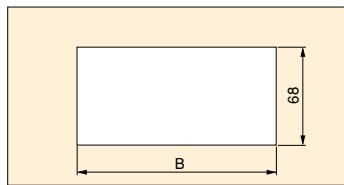

Aluminium/Aluminium

Plaswire 85 desk cable grommet (78x78mm)
Przepust kablowy stołowy Plaswire 85 (78x78mm)

Finishing/Wykończenie	Packaging/Opakowanie	Cod.
White painted/Malowane na biało 	15 Unit/Szt	5012512
Black painted/Malowane na czarno 	15 Unit/Szt	5012514

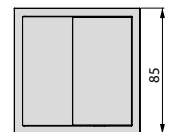
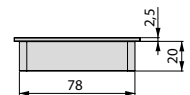
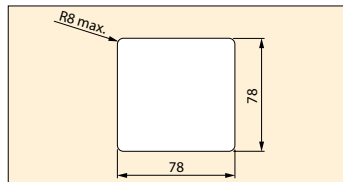
Plastic/Plastik



Plaswire 152 desk cable grommet (146x56mm)
Przepust kablowy stołowy Plaswire 152 (146x56mm)

Finishing/Wykończenie	Packaging/Opakowanie	Cod.
White painted/Malowane na biało 	10 Unit/Szt	5012612
Black painted/Malowane na czarno 	10 Unit/Szt	5012614

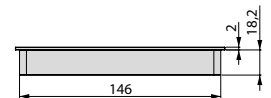
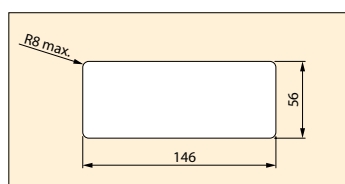
Plastic/Plastik



Pipe 4 Cable grommet column
Kregosłupy kablowe Pipe 4

Finishing/Wykończenie	Packaging/Opakowanie	Cod.
Silver painted/Malowane aluminium 	10 Unit/Szt	6210025

Plastic/Plastik

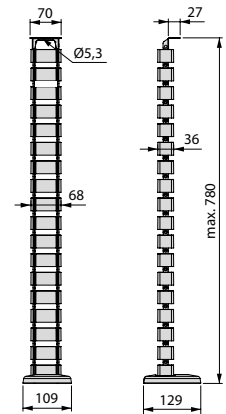

Hexa cable grommet column
Kregosłupy kablowe Hexa

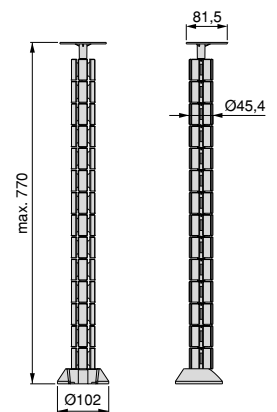

Finishing/Wykończenie	Packaging/Opakowanie	Cod.
Black plastic/Czarny plastik 	1 Unit/Szt	3025917

Plastic/Plastik



Tilting and rotating 360 ° desk monitor stands for table.
uchwyty na monitor na biurko, uchylne i obrotowe o 360 °.



Description/Opis	Finishing/Wykończenie		Packaging/Opakowanie	Cod.
Simple/Proste	Black painted/Malowane na czarno		1 Unit/Szt	3200014
Double/Podwójne	Black painted/Malowane na czarno		1 Unit/Szt	3200114

Steel/Stal

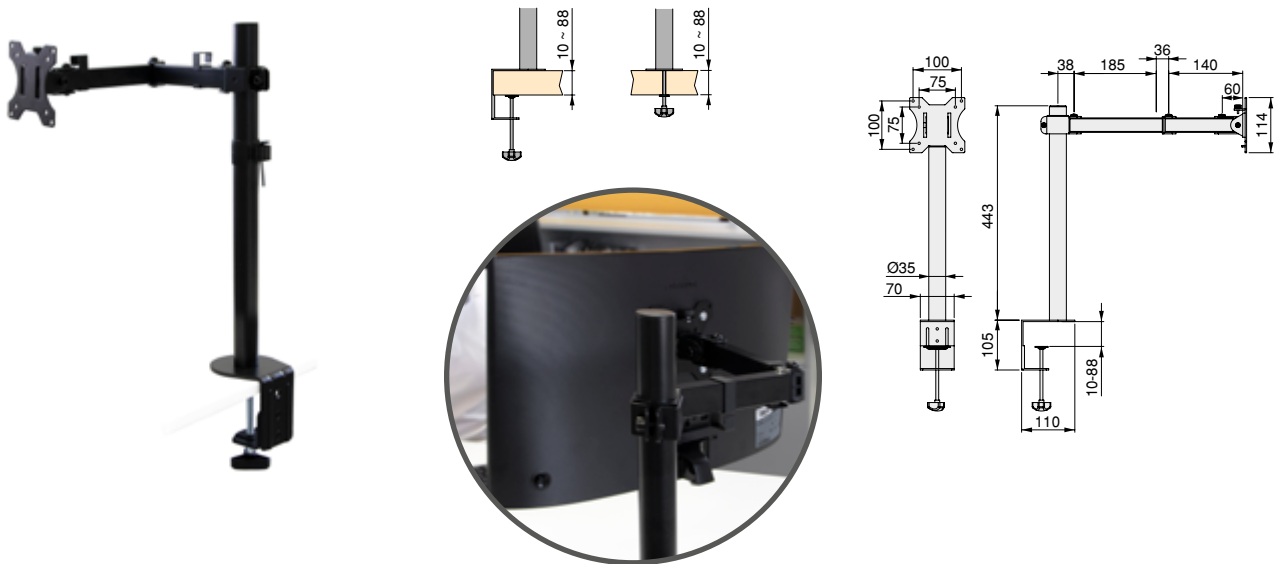

CPU support

Uchwyt na komputer



Finishing/Wykończenie		Packaging/Opakowanie	Cod.
Silver painted/Malowane aluminium		1 Unit/Szt	6216925

Steel/Stal

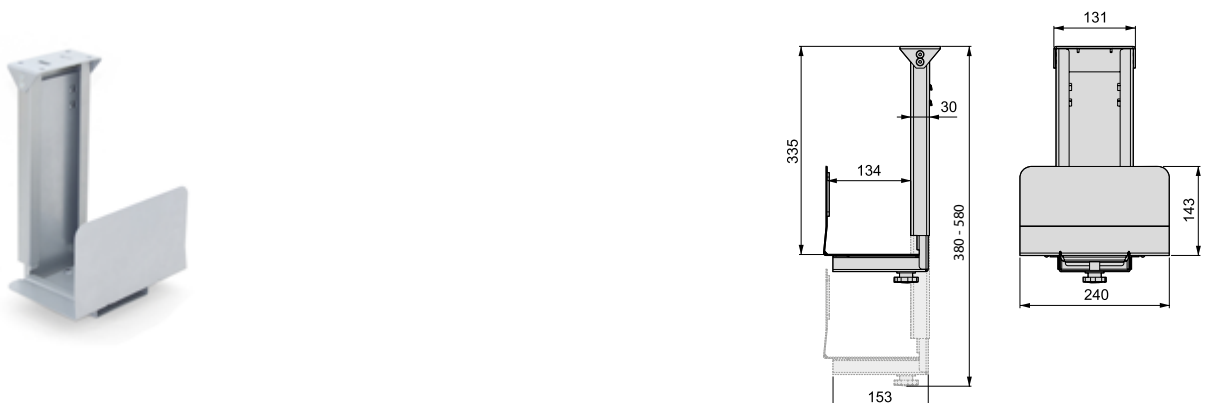

Giro 4 Rotating base
Podstawa obrotowa Giro 4



Finishing/Wykończenie	Packaging/Opakowanie	Cod.
Zinc plated/Cynkowane 	10 Unit/Szt	3198305

Steel/Stal

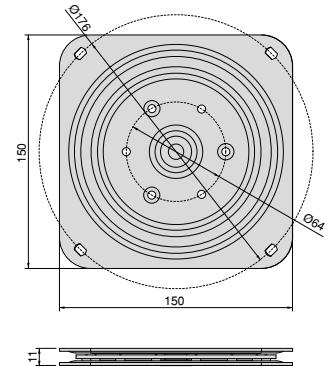
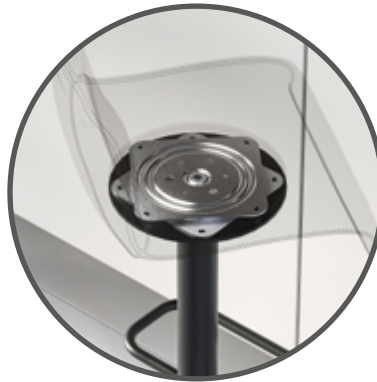
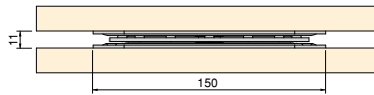

Giro1 Rotating base
Podstawa obrotowa Giro1



Finishing/Wykończenie	Packaging/Opakowanie	Cod.
Black painted/Malowane na czarno 	20 Unit/Szt	4952614

Steel/Stal

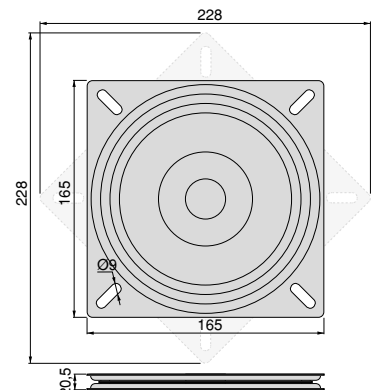
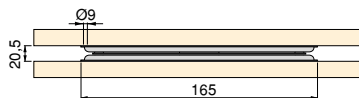

Set of ball bearing keyboard runners in steel
Zestaw prowadnic pod klawiaturę, stal

Finishing/Wykończenie	Packaging/Opakowanie	Cod.
Silver painted/Malowane aluminium 	1 Pair/Kpl.	3026025

Steel/Stal

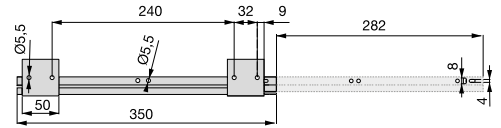
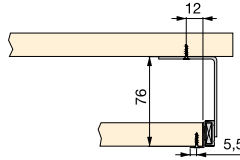

Ball bearing keyboard holder runners kit, Steel
Zestaw prowadnic kulkowych do klawiatury z regulacją wysokości, stal



Finishing/Wykończenie	Packaging/Opakowanie	Cod.
Black zinc plated/Cynkowana czerni 	20 Unit/Szt	4193409

Steel/Stal

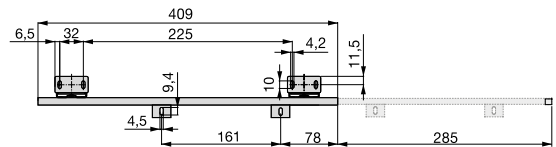
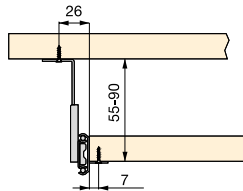

Mickey2 keyboard holder
Uchwyt na klawiaturę Mickey2

Finishing/Wykończenie	Packaging/Opakowanie	Cod.
Grey plastic/Szary plastik 	5 Unit/Szt	4193121

Plastic, Steel/Plastik, Stal

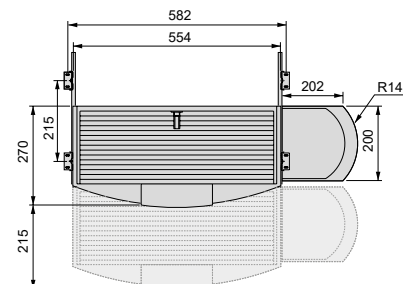
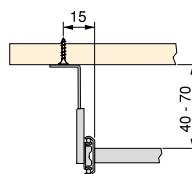

Automatic TV stand Lift - Vision
Uchwyt do telewizora Lift - Vision

Finishing/Wykończenie	Packaging/Opakowanie	Cod.
Black painted/Malowane na czarno 	1 Unit/Szt	6009814

Steel/Stal

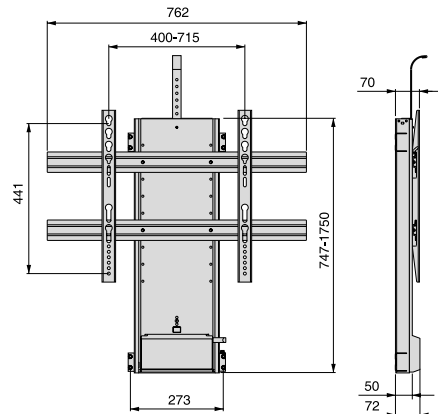
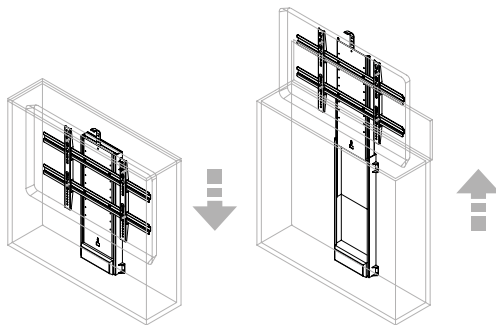

- Motorized lifting support for televisions.
- Route of the support until a meter.
- Has a manual switch which can be set into the cabinet, and a radio operated remote control.
- It requires an electrical supply of 110-240 VAC / 50-60Hz.
- Includes a type G adapter (UK).
- A push-back safety mechanism is in place to avoid anything getting caught as the television is lowered.
- End of adjustable race in the slope.
- Loads from 5kg minimum through to 100 kg maximum.
- Compatible with televisions VESA: 200x100 - 200x200 - 300x300 - 400x100 - 400x200 - 400x400 - 600x100 - 600x200 - 600x400.

- Wspornik podnoszący z silnikiem dla telewizorów.
- Wysuw wspornika nawet do 1 metra.
- Wyposażona w ręczny wyłącznik, który można umieścić w szafce, zdalne sterowanie radiowe.
- Wymaga zasilania 110-240 VAC / 50-60Hz.
- W zestawie adapter typu G (UK).
- Zainstalowany zabezpieczający mechanizm odbijający, aby zapobiec zaklinowaniu przy obniżaniu telewizora.
- Zakończenie nastawnej bieżni w nachyleniu.
- Obsługuje obciążenia: minimum 5 kg i maksimum 100 kg.
- Kompatybilne z telewizorami VESA: 200x100 - 200x200 - 300x300 - 400x100 - 400x200 - 400x400 - 600x100 - 600x200 - 600x400.