

Placard

SISTEMA SCORREVOLI
SCHIEBESYSTEME



Scorrevoli Schiebesysteme

PLACARD 74 / 81 / 90

Sistema per armadi con ante scorrevoli appoggiate. Le guide superiori e i carrelli inferiori sono in acciaio verniciato o zincato. I carrelli inferiori sono dotati di cuscinetti a sfera. Consente l'utilizzo della chiusura morbida in apertura e chiusura per più ante. I carrelli inferiori sono dotati di un meccanismo di blocco per l'inserimento dei carrelli inferiori nella guida inferiore.

70kg

slow

±7,5

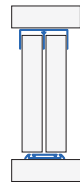

System für Schränke mit unterstützten Schiebetüren. Die oberen und unteren Laufwagen sind aus lackiertem oder verzinktem Stahl gefertigt. Die unteren Laufwagen sind mit Kugellagern ausgestattet. Es ermöglicht die Verwendung von Soft Closing beim Öffnen und Schließen mehrerer Türen. Die unteren Laufwagen sind mit einem Blockiermechanismus für das Einsetzen der unteren Laufwagen in die untere Schiene ausgestattet.



KITS

KIT Placard, con tutti i raccordi e i profili necessari per il montaggio e l'installazione, ad eccezione dei pannelli.

Placard KIT, mit allen Beschlägen und Profilen, die für den Zusammenbau und die Installation erforderlich sind, mit Ausnahme der Platten.

Scegliete uno dei due carrelli Placard per progettare il vostro armadio, con ruote Ø45 o Ø50.

Wählen Sie zwischen einem der beiden Placard-Wagen, um Ihren Kleiderschrank zu gestalten, mit Ø45 oder Ø50 Rollen.

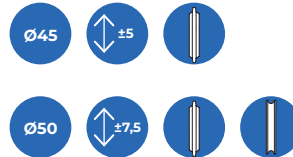

Configuratore Placard.
Placard-Konfigurator.



Video di montaggio.
Video der Montage.

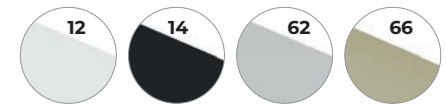
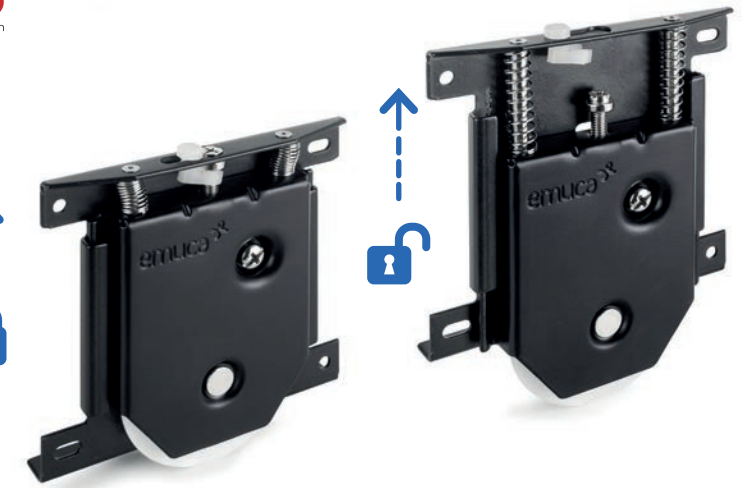

Gamma di finiture Placard.

Auswahl an Oberflächen Placard.

PLACARD74

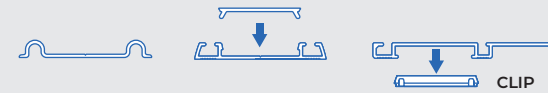

PLACARD81

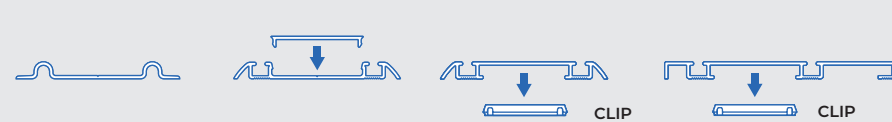

PLACARD90



Binari adatti a spessori di pannelli di 16-18-19 mm e diversi modelli per il montaggio.

Schienen für Plattenstärken von 16 -18-19 mm und verschiedene Modelle für die Montage.

Placard 74

Utilizzabile per 2 e 3 ante.
Scorrimento su cuscinetti a sfera.
Pattino inferiore regolabile in altezza $\pm 7,5$ mm con freni o ± 5 mm con Soft.
Sistema di anti scarrellamento mediante molla nel pattino inferiore.
Dispone di meccanismo di blocco della molla del pattino inferiore che facilita la installazione delle ante.
Chiusura soft in apertura e chiusura su 2 ante.
Freno superiore che permette comunque l'apertura in entrambi i lati della anta.

Für 2 und 3 Türen anwendbar.
Mit Kugellager.
Höhenverstellbares Fahrwerk $\pm 7,5$ mm mit Bremsen oder ± 5 mm mit Soft.
Anti-Entgleisungssystem durch Feder an der unteren Schiene und einstellbarer Anti-Sprung-Stopper an den oberen Rollen.
Es verfügt über Verriegelungsmechanismen für die untere Feder der Schiene, die die Installation der Türen erleichtern.
Sanftes Schließen beim Öffnen und Schließen in 2 Türen.
Oberer Stopper, der das Öffnen in beide Richtungen ermöglicht.

Set di ferramenta ammortizzatori Placard 74 per 1 anta scorrevole Placard 74 Beschläge-Satz für Schiebetüren mit sanftem Schließen

Portata/Belastung	Spessore pannello/Platten-dicke	Finitura/Fertigstellung	Imballaggio/Verpackung	Cod.
30 Kg	16 - 18 - 19	Non classificata/Nicht bestimmt	2 KIT/SET	6108320
50 Kg	16 - 18 - 19	Non classificata/Nicht bestimmt	2 KIT/SET	6108420

Tecnoplastica/Kunststoff

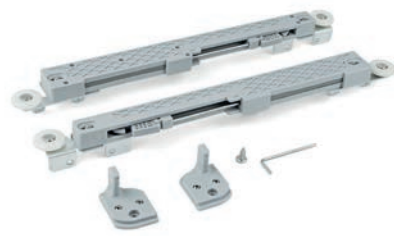

Set di carrelli Placard con ruota Ø45 per 1 anta scorrevole fino a 70kg per ammortizzatori Beschlagsatz Placard mit Rad Ø45 für 1 Schiebetür 70kg für Softclosing

Modello/Modell	Finitura/Fertigstellung	Imballaggio/Verpackung	Cod.
Canale/Rille	Non classificata/Nicht bestimmt	4 KIT/SET	6188720

Acciaio, Tecnoplastica/Kunststoff, Stahl



Set di carrelli Placard con ruota Ø50 per 1 anta scorrevole fino a 70kg per ammortizzatori Beschlagsatz Placard mit Rad Ø50 für 1 Schiebetür 70kg für Softclosing

Modello/Modell	Finitura/Fertigstellung	Imballaggio/Verpackung	Cod.
Canale/Rille	Non classificata/Nicht bestimmt	4 KIT/SET	6108020
Classico/Klassisch	Non classificata/Nicht bestimmt	4 KIT/SET	6108120

Acciaio, Tecnoplastica/Kunststoff, Stahl

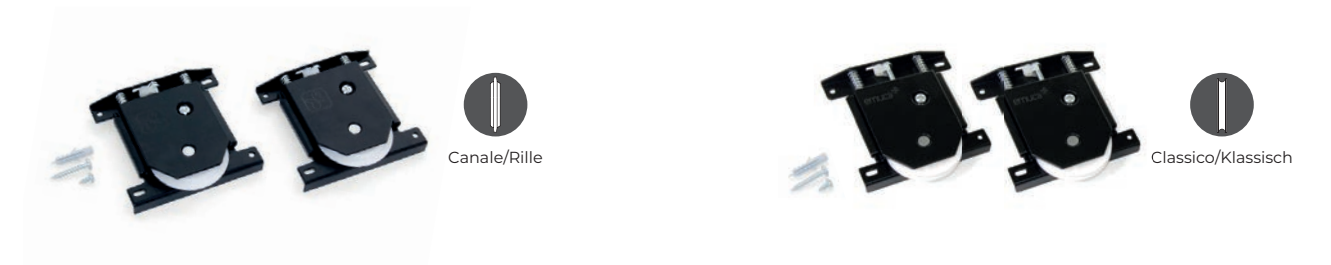

Set di carrelli Placard 74 con ruota Ø45 per 1 anta scorrevole fino a 70kg con freni Beschlagsatz Placard 74 mit Ø45 Rad für 1 Schiebetür 70kg mit Bremse

Modello/Modell	Finitura/Fertigstellung	Imballaggio/Verpackung	Cod.
Canale/Rille	Non classificata/Nicht bestimmt	4 KIT/SET	6188920

Acciaio, Tecnoplastica/Kunststoff, Stahl



Set di carrelli Placard 74 con ruota Ø50 per 1 anta scorrevole fino a 70kg con freni Beschlagsatz Placard 74 mit Ø50 Rad für 1 Schiebetür 70kg mit Bremse

Portata/Belastung	Spessore pannello/Plat-tendicke	Modello/Modell	Finitura/Fertigstellung	Imballaggio/Verpackung	Cod.
70 Kg	16 - 18 - 19	Canale/Rille	Non classificata/Nicht bestimmt	4 KIT/SET	6109920
70 Kg	16 - 18 - 19	Clásico/Clásica	Sin determinar/Sem determinar	4 KIT/KIT	6189020

Acciaio, Tecnoplastica/Kunststoff, Stahl



Carrello inferiore Placard con ruota Ø45
 Laufrollen Placard für Schiebetürsysteme Ø45

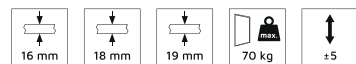

Modello/Modell	Finitura/Fertigstellung	Imballaggio/Verpackung	Cod.
Canale/Rille	Zincato bianco/Verzinkt	50 UN/Einh	6188605

Acciaio, Tecnoplastica/Kunststoff, Stahl

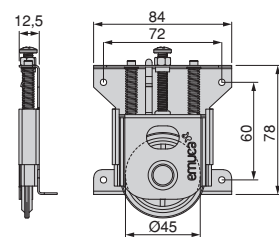

Carrello inferiore Placard con ruota Ø50
 Laufrollen Placard für Schiebetürsysteme Ø50



Modello/Modell	Finitura/Fertigstellung	Imballaggio/Verpackung	Cod.
Classico/Klassisch	Verniciato nero/Schwarz	50 UN/Einh	6012214
Canale/Rille	Verniciato nero/Schwarz	50 UN/Einh	6102114

Acciaio, Tecnoplastica/Kunststoff, Stahl



Canale/Rille



Classico/Klassisch

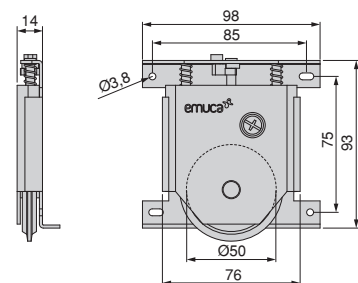

Pattino superiore Placard 74 per porte scorrevoli
 Placard 74 obere Rollen für Schiebetürsysteme

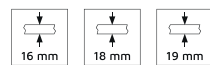

Spessore pannello/Plattendicke	Finitura/Fertigstellung	Imballaggio/Verpackung	Cod.
16 - 18 - 19	Zincato bianco/Verzinkt	100 UN/Einh	6188805

Acciaio, Tecnoplastica/Kunststoff, Stahl

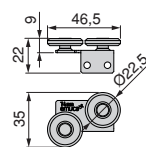

Freno Placard per porte scorrevoli
 Placard-Stopper für Schiebetürsysteme

Finitura/Fertigstellung	Imballaggio/Verpackung	Cod.
Grigia/Grau	100 UN/Einh	6102021

Tecnoplastica/Kunststoff



Placard

Ø45 Canal

Ø50 Canal

Ø50 Classic/Clásica

Binari superiori Placard 74 a Canale per porte scorrevoli
Obere Schiene für Placard 74 für Schiebetürsysteme

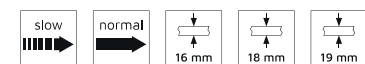

Lunghezza/Längengrad	Finitura/Fertigstellung	Imballaggio/Verpackung	Cod.
2,35 m	Verniciato bianco/Weiß	8 UN/Einh	6056912
3,9 m	Verniciato bianco/Weiß	8 UN/Einh	6054512
2,35 m	Verniciato nero/Schwarz	8 UN/Einh	6056914
3,9 m	Verniciato nero/Schwarz	8 UN/Einh	6054514
2,35 m	Anodizzato opaco/Matt eloxiert	8 UN/Einh	6056962
3,9 m	Anodizzato opaco/Matt eloxiert	8 UN/Einh	6054562
3,9 m	Anodizzato oro/Gold eloxiert	8 UN/Einh	6054566

Alluminio/Aluminium

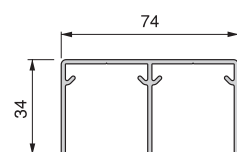

Binario inferiore Placard 74 a Canale Clip per porte scorrevoli
Untere Laufschiene Placard 74 Clip für Schiebetürsysteme

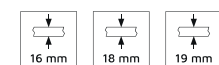

Lunghezza/Längengrad	Finitura/Fertigstellung	Imballaggio/Verpackung	Cod.
2,35 m	Verniciato bianco/Weiß	8 UN/Einh	6300112
3,9 m	Verniciato bianco/Weiß	8 UN/Einh	6055112
2,35 m	Verniciato nero/Schwarz	8 UN/Einh	6300114
3,9 m	Verniciato nero/Schwarz	8 UN/Einh	6055114
2,35 m	Anodizzato opaco/Matt eloxiert	8 UN/Einh	6300162
3,9 m	Anodizzato opaco/Matt eloxiert	8 UN/Einh	6055162
3,9 m	Anodizzato oro/Gold eloxiert	8 UN/Einh	6055166

Alluminio/Aluminium

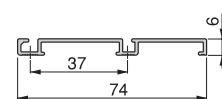

Clip per porte scorrevoli Placard
Clip für Schienen Placard für Schiebetürsysteme

Finitura/Fertigstellung	Imballaggio/Verpackung	Cod.
Nera/Schwarzer	25 UN/Einh	6009017

Tecnoplastica/Kunststoff

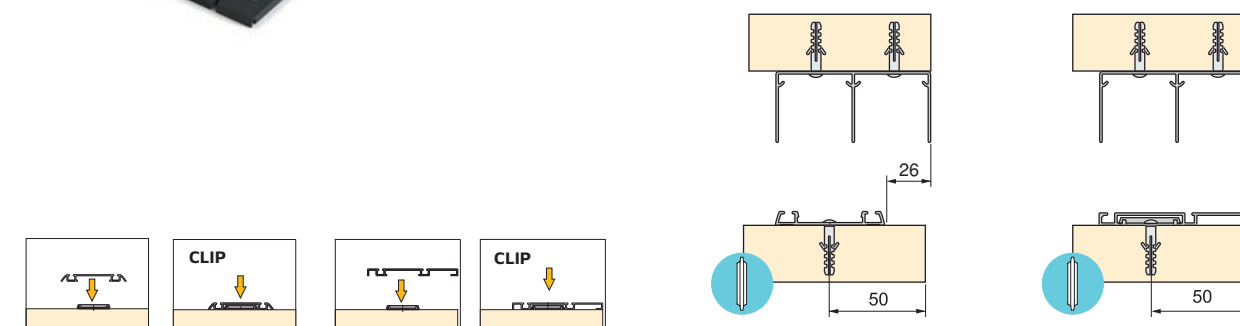

Binario inferiore Placard 74 a Canale
Placard 74 untere Laufschiene

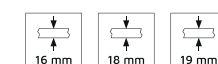

Lunghezza/Längengrad	Finitura/Fertigstellung	Imballaggio/Verpackung	Cod.
2,35 m	Pintado blanco/Pintado branco	8 UN/Einh	6056712
3,9 m	Pintado blanco/Pintado branco	8 UN/Einh	6054812
3,9 m	Verniciato nero/Schwarz	8 UN/Einh	6054814
2,35 m	Anodizzato opaco/Matt eloxiert	8 UN/Einh	6056762
3,9 m	Anodizzato opaco/Matt eloxiert	8 UN/Einh	6054862
3,9 m	Anodizzato oro/Gold eloxiert	8 UN/Einh	6054866

Alluminio/Aluminium

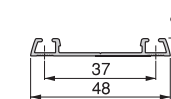

Profilo tappo Placard 74 a Canale per porte scorrevoli
 Profil Abdeckkappe Placard 74 für Schiebetürsysteme

Lunghezza/Längengrad	Finitura/Fertigstellung	Imballaggio/Verpackung	Cod.
2,35 m	Verniciato bianco/Weiß	16 UN/Einh	6058412
3,9 m	Verniciato bianco/Weiß	16 UN/Einh	6058512
3,9 m	Verniciato nero/Schwarz	16 UN/Einh	6058514
2,35 m	Anodizzato opaco/Matt eloxiert	16 UN/Einh	6058462
3,9 m	Anodizzato opaco/Matt eloxiert	16 UN/Einh	6058562
3,9 m	Anodizzato oro/Gold eloxiert	16 UN/Einh	6058566

Alluminio/Aluminium

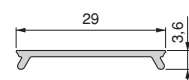

Binario inferiore Placard 74 Classico per porte scorrevoli
 Untere Schiene Placard 74 "Clasico" für Schiebetürsysteme

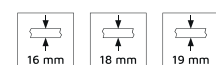

Lunghezza/Längengrad	Finitura/Fertigstellung	Imballaggio/Verpackung	Cod.
3,9 m	Anodizado mate/Anodizado mate	8 UN/Einh	6058662

Alluminio/Aluminio

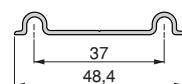

Placard



Placard 74



MANIGLIE / GRIFFE PLACARD 74



Maniglia per armadio Wave 16
Griff für Schiebetüren Wave 16



Lunghezza/Längengrad	Finitura/Fertigstellung	Imballaggio/Verpackung	Cod.
2,35 m	Verniciato bianco/Weiß	8 UN/Einh	6057512
2,7 m	Verniciato bianco/Weiß	8 UN/Einh	6053212
2,35 m	Verniciato nero/Schwarz	8 UN/Einh	6057514
2,7 m	Verniciato nero/Schwarz	8 UN/Einh	6053214
2,35 m	Anodizzato opaco/Matt eloxiert	8 UN/Einh	6057562
2,7 m	Anodizzato opaco/Matt eloxiert	8 UN/Einh	6053262

Alluminio/Aluminium

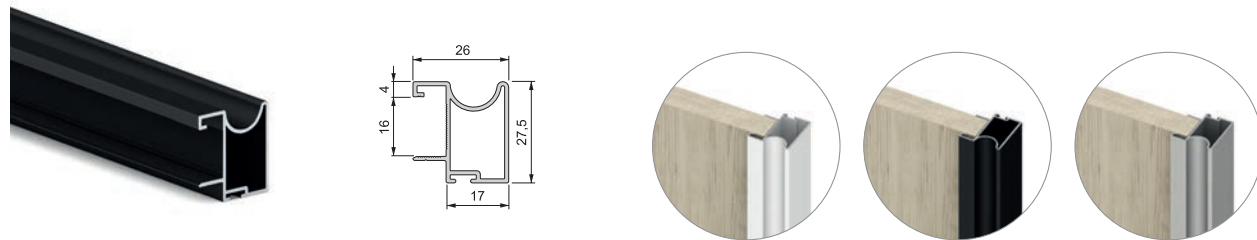

Placard 74 / Placard 74 MANIGLIE PLACARD 74 / GRIFFE PLACARD 74



Maniglia per armadio Sharp 16
Griff für Schiebetüren Sharp 16



Lunghezza/Längengrad	Finitura/Fertigstellung	Imballaggio/Verpackung	Cod.
2,35 m	Verniciato bianco/Weiß	8 UN/Einh	6306712
2,7 m	Verniciato bianco/Weiß	8 UN/Einh	6053412
2,35 m	Verniciato nero/Schwarz	8 UN/Einh	6306714
2,7 m	Verniciato nero/Schwarz	8 UN/Einh	6053414
2,35 m	Anodizzato opaco/Matt eloxiert	8 UN/Einh	6306762
2,7 m	Anodizzato opaco/Matt eloxiert	8 UN/Einh	6053462
2,7 m	Anodizzato oro/Gold eloxiert	8 UN/Einh	6053466

Alluminio/Aluminium

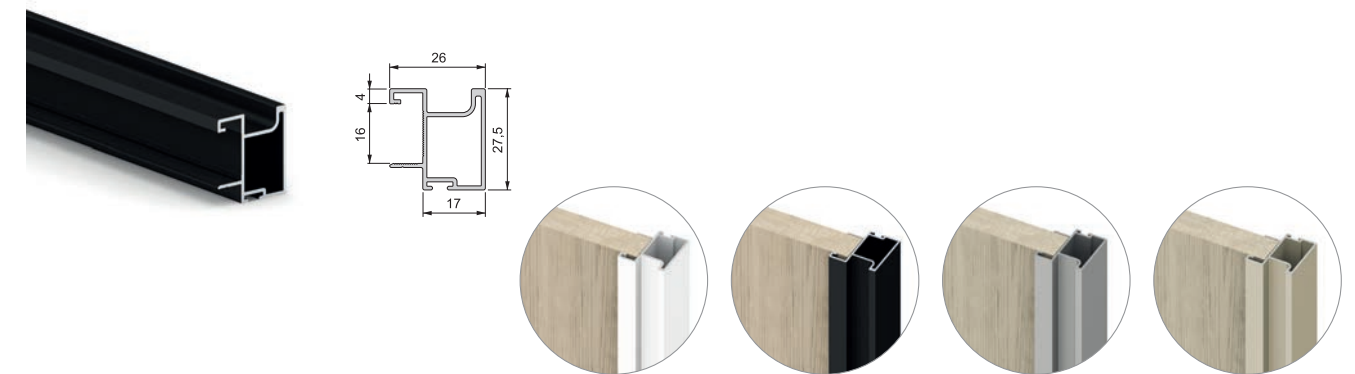

Maniglia per armadio Style 16
Griff für Schiebetüren Style 16



Lunghezza/Längengrad	Finitura/Fertigstellung	Imballaggio/Verpackung	Cod.
2,7 m	Verniciato bianco/Weiß	8 UN/Einh	6053012
2,35 m	Anodizzato opaco/Matt eloxiert	8 UN/Einh	6306862
2,7 m	Anodizzato opaco/Matt eloxiert	8 UN/Einh	6053062

Alluminio/Aluminium

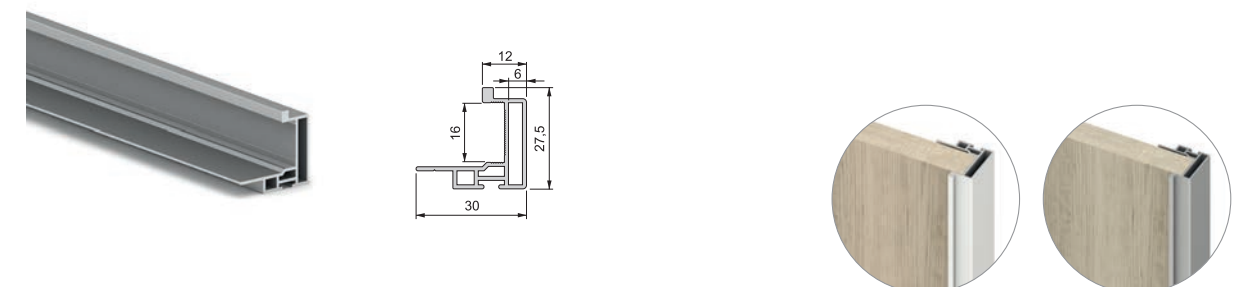

Tirador para armario Wave 18
Puxador para roupeiro Wave 18



Lunghezza/Längengrad	Finitura/Fertigstellung	Imballaggio/Verpackung	Cod.
2,5 m	Verniciato bianco/Weiß	8 UN/Einh	6058212
3,9 m	Verniciato bianco/Weiß	8 UN/Einh	6053612
2,5 m	Verniciato nero/Schwarz	8 UN/Einh	6058214
3,9 m	Verniciato nero/Schwarz	8 UN/Einh	6054814
2,35 m	Anodizzato opaco/Matt eloxiert	8 UN/Einh	6056762
3,9 m	Anodizzato opaco/Matt eloxiert	8 UN/Einh	6054862

Alluminio/Aluminium



Maniglia per armadio Sharp 18
Griff für Schiebetüren Sharp 18



Lunghezza/Längengrad	Finitura/Fertigstellung	Imballaggio/Verpackung	Cod.
2,5 m	Verniciato bianco/Weiß	8 UN/Einh	6058112
2,9 m	Verniciato bianco/Weiß	8 UN/Einh	6053812
2,35 m	Verniciato nero/Schwarz	8 UN/Einh	6057114
2,5 m	Verniciato nero/Schwarz	8 UN/Einh	6058114
2,9 m	Verniciato nero/Schwarz	8 UN/Einh	6053814
2,35 m	Anodizzato opaco/Matt eloxiert	8 UN/Einh	6057162
2,5 m	Anodizzato opaco/Matt eloxiert	8 UN/Einh	6058162
2,9 m	Anodizzato opaco/Matt eloxiert	8 UN/Einh	6053862
2,9 m	Anodizzato oro/Gold eloxiert	8 UN/Einh	6053866

Alluminio/Aluminium

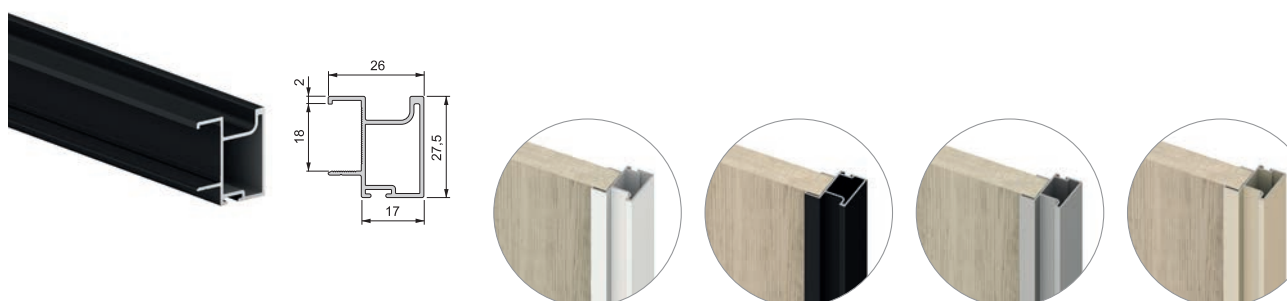

Maniglia per armadio Wave 19
Griff für Schiebetüren Wave 19



Lunghezza/Längengrad	Finitura/Fertigstellung	Imballaggio/Verpackung	Cod.
2,7 m	Verniciato bianco/Weiß	8 UN/Einh	6054012
2,35 m	Anodizzato opaco/Matt eloxiert	8 UN/Einh	6300662
2,7 m	Anodizzato opaco/Matt eloxiert	8 UN/Einh	6054062

Alluminio/Aluminium

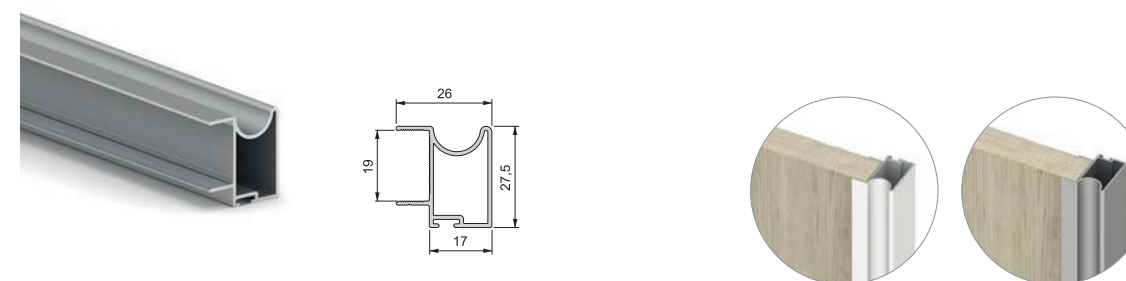

Maniglia per armadio Sharp 19
Griff für Schiebetüren Sharp 19



Lunghezza/Längengrad	Finitura/Fertigstellung	Imballaggio/Verpackung	Cod.
2,35 m	Verniciato bianco/Weiß	8 UN/Einh	6307312
2,7 m	Verniciato bianco/Weiß	8 UN/Einh	6054212
2,35 m	Verniciato nero/Schwarz	8 UN/Einh	6307314
2,7 m	Verniciato nero/Schwarz	8 UN/Einh	6054214
2,35 m	Anodizzato opaco/Matt eloxiert	8 UN/Einh	6307362
2,7 m	Anodizzato opaco/Matt eloxiert	8 UN/Einh	6054262

Alluminio/Aluminium

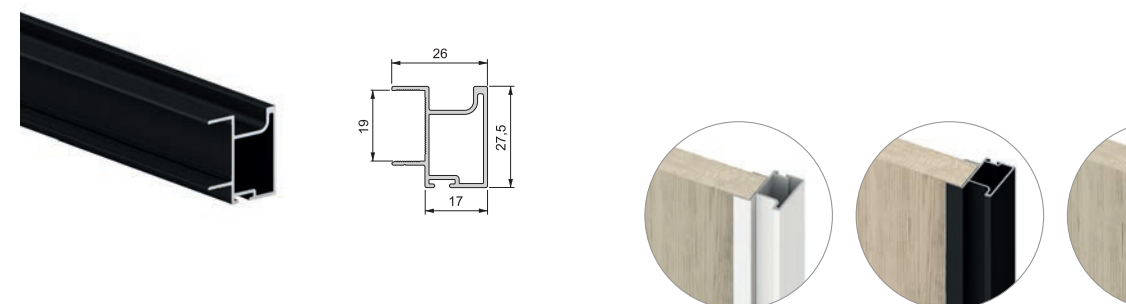

Traverso Placard H10
 Querbalken Placard H10



Lunghezza/Längengrad	Finitura/Fertigstellung	Imballaggio/Verpackung	Cod.
2,35 m	Verniciato bianco/Weiß	8 UN/Einh	6305512
2,35 m	Verniciato nero/Schwarz	8 UN/Einh	6305514
2,35 m	Anodizzato opaco/Matt eloxiert	8 UN/Einh	6305562

Alluminio/Aluminium

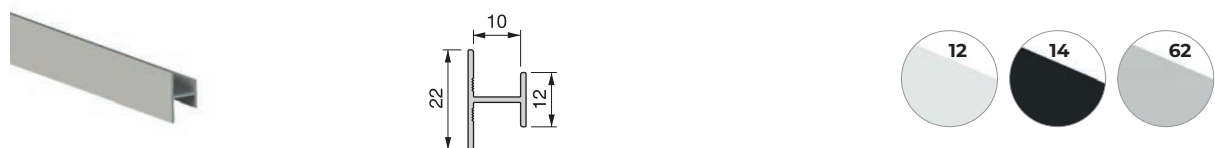

Traverso Placard H16x18
 Querbalken Placard H16x18



Lunghezza/Längengrad	Finitura/Fertigstellung	Imballaggio/Verpackung	Cod.
2,35 m	Verniciato bianco/Weiß	8 UN/Einh	6300812
2,35 m	Verniciato nero/Schwarz	8 UN/Einh	6300814
2,35 m	Anodizzato opaco/Matt eloxiert	8 UN/Einh	6300862

Alluminio/Aluminium

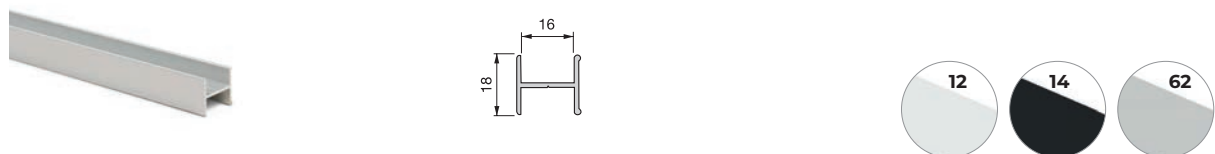

Travesaños Placard H16x12/22
 Perfis Japonesa Placard H16x12/22



Lunghezza/Längengrad	Finitura/Fertigstellung	Imballaggio/Verpackung	Cod.
2,35 m	Verniciato bianco/Weiß	8 UN/Einh	6031912
2,35 m	Verniciato nero/Schwarz	8 UN/Einh	6031914
2,35 m	Anodizzato opaco/Matt eloxiert	8 UN/Einh	6031962
2,35 m	Anodizzato oro/Gold eloxiert	8 UN/Einh	6031966

Alluminio/Aluminium

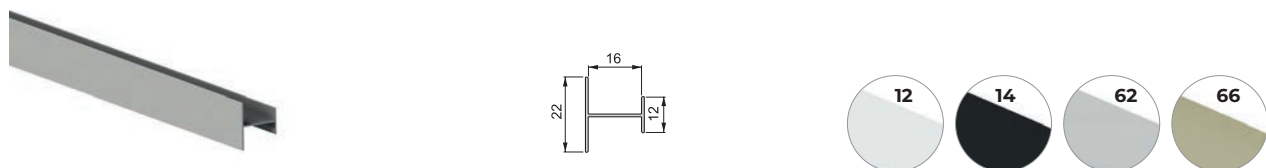

Travesaños Placard H16Ex12/22
 Perfis Japonesa Placard H16Ex12/22



Lunghezza/Längengrad	Finitura/Fertigstellung	Imballaggio/Verpackung	Cod.
2,8 m	Anodizzato opaco/Matt eloxiert	8 UN/Einh	6031862

Alluminio/Aluminium

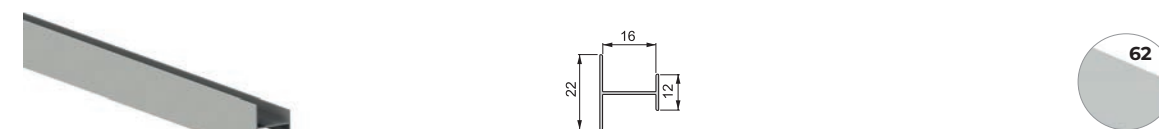

Traverso Placard H18x12/22
 Querbalken Placard H18x12/22



Lunghezza/Längengrad	Finitura/Fertigstellung	Imballaggio/Verpackung	Cod.
2,35 m	Verniciato bianco/Weiß	8 UN/Einh	6305612
2,35 m	Verniciato nero/Schwarz	8 UN/Einh	6305614
2,35 m	Anodizzato opaco/Matt eloxiert	8 UN/Einh	6305662
2,35 m	Anodizzato oro/Gold eloxiert	8 UN/Einh	6305666

Alluminio/Aluminium

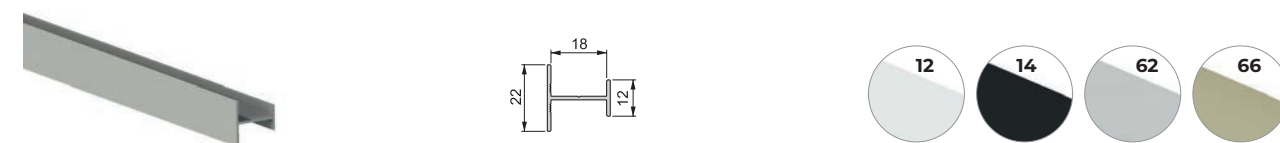

Traverso Placard H19x12/22
 Querbalken Placard H19x12/22



Lunghezza/Längengrad	Finitura/Fertigstellung	Imballaggio/Verpackung	Cod.
2,35 m	Verniciato bianco/Weiß	8 UN/Einh	6102912
2,35 m	Verniciato nero/Schwarz	8 UN/Einh	6102914
2,35 m	Anodizzato opaco/Matt eloxiert	8 UN/Einh	6102962

Alluminio/Aluminium

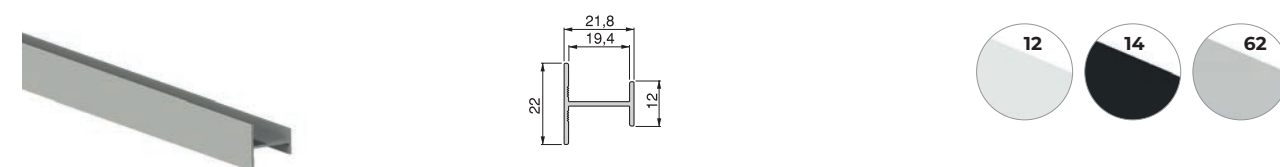

Traverso Placard U10x16
 Querbalken Placard U10x16



Lunghezza/Längengrad	Finitura/Fertigstellung	Imballaggio/Verpackung	Cod.
2,35 m	Verniciato bianco/Weiß	8 UN/Einh	6302712
2,35 m	Verniciato nero/Schwarz	8 UN/Einh	6302714
2,35 m	Anodizado mate/Anodizado mate	8 UN/Einh	6302762

Alluminio/Aluminium

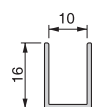

Traverso Placard U16x14
 Querbalken Placard U16x14



Lunghezza/Längengrad	Finitura/Fertigstellung	Imballaggio/Verpackung	Cod.
2,35 m	Verniciato bianco/Weiß	8 UN/Einh	6300312
2,35 m	Verniciato nero/Schwarz	8 UN/Einh	6300314
2,35 m	Anodizzato opaco/Matt eloxiert	8 UN/Einh	6300362
2,35 m	Anodizzato oro/Gold eloxiert	8 UN/Einh	6300366

Alluminio/Aluminium

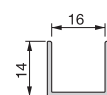

Traverso Placard U18x14
 Querbalken Placard U18x14



Lunghezza/Längengrad	Finitura/Fertigstellung	Imballaggio/Verpackung	Cod.
2,9 m	Verniciato bianco/Weiß	8 UN/Einh	6305912
2,9 m	Verniciato nero/Schwarz	8 UN/Einh	6305914
2,35 m	Anodizado mate/Anodizado mate	8 UN/Einh	6305762
2,9 m	Anodizado mate/Anodizado mate	8 UN/Einh	6305962
2,9 m	Anodizzato oro/Gold eloxiert	8 UN/Einh	6305966

Alluminio/Aluminium

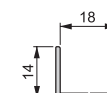

Traverso Placard U19x14
 Querbalken Placard U19x14



Lunghezza/Längengrad	Finitura/Fertigstellung	Imballaggio/Verpackung	Cod.
2,35 m	Verniciato bianco/Weiß	8 UN/Einh	6103112
2,35 m	Verniciato nero/Schwarz	8 UN/Einh	6103114
2,35 m	Anodizzato opaco/Matt eloxiert	8 UN/Einh	6103162

Alluminio/Aluminium

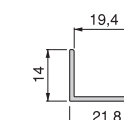

Sistema scorrevole per armadio 2 ante a scorrimento inferiore Placard 74 con profili Wave e chiusura soft
Schiebetürensysteem für Schrank mit 2 Türen Laufrollen untere Schiene Placard 74 mit Profilen Wave und sanftem Schließen

Spessore pannello/Plattendicke	Finitura/Fertigstellung	Imballaggio/Verpackung	Cod.
16	Verniciato bianco/Weiß	1 KIT/SET	6031312

Alluminio/Aluminium



KITS

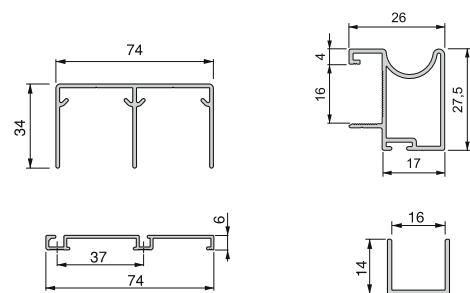

Le binari e i profili superiori e inferiori sono forniti in una dimensione di 2.350 mm.

Die oberen und unteren Schienen und Profile werden in einer Abmessung von 2.350 mm geliefert.

Sistema scorrevole per armadio 2 ante a scorrimento inferiore Placard 74 con profili Sharp e chiusura soft
Schiebetürensysteem für Schrank mit 2 Türen Laufrollen untere Schiene Placard 74 mit Profilen Sharp und sanftem Schließen

Spessore pannello/Plattendicke	Finitura/Fertigstellung	Imballaggio/Verpackung	Cod.
16	Verniciato nero/Schwarz	1 KIT/SET	6015514

Alluminio/Aluminium



KITS

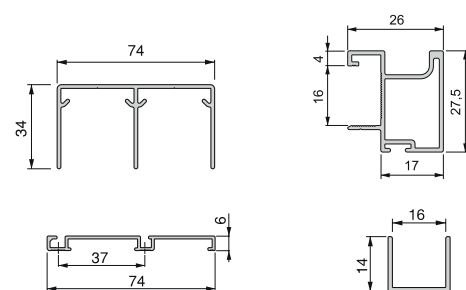

Le binari e i profili superiori e inferiori sono forniti in una dimensione di 2.350 mm.

Die oberen und unteren Schienen und Profile werden in einer Abmessung von 2.350 mm geliefert.

Set di binari per Placard 74 a Canale
Placard 74 Laufschiensatz

Lunghezza/Längengrad	Finitura/Fertigstellung	Imballaggio/Verpackung	Cod.
2,35 m	Anodizzato opaco/Matt eloxiert	1 UN/Einh	6307762
3,9 m	Anodizzato opaco/Matt eloxiert	1 UN/Einh	6055562

Alluminio/Aluminium

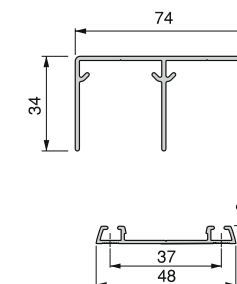

Set di binari per Placard 74 a Canale clip
Placard 74 versenkter Laufschiensatz mit Clip

Lunghezza/Längengrad	Finitura/Fertigstellung	Imballaggio/Verpackung	Cod.
2,35 m	Verniciato bianco/Weiß	1 UN/Einh	6307912
3,9 m	Verniciato bianco/Weiß	1 UN/Einh	6055812
2,35 m	Verniciato nero/Schwarz	1 UN/Einh	6307914
3,9 m	Verniciato nero/Schwarz	1 UN/Einh	6055814
2,35 m	Anodizzato opaco/Matt eloxiert	1 UN/Einh	6307962
3,9 m	Anodizzato opaco/Matt eloxiert	1 UN/Einh	6055862

Alluminio/Aluminium

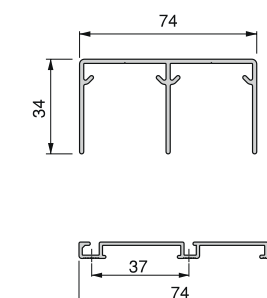
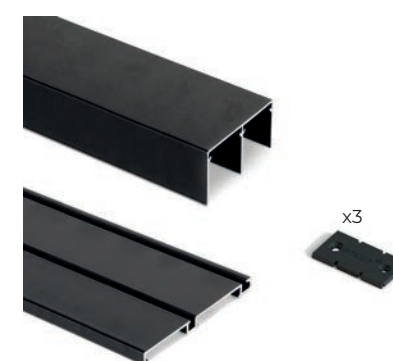

x3

Set de maniglie Wave 16 e 19 per una porta scorrevole
Satz Wave Griffe 16 und 19 für eine Schiebetür

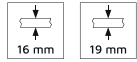

Spessore pannello/Plattendicke	Lunghezza/Längengrad	Finitura/Fertigstellung	Imballaggio/Verpackung	Cod.
16	2,35 m	Verniciato bianco/Weiß	1 UN/Einh	6308112
19	2,7 m	Verniciato bianco/Weiß	1 KIT/SET	6311312
16	2,35 m	Anodizzato opaco/Matt eloxiert	1 KIT/SET	6308162
19	2,7 m	Anodizzato opaco/Matt eloxiert	1 KIT/SET	6311362

Alluminio/Aluminium

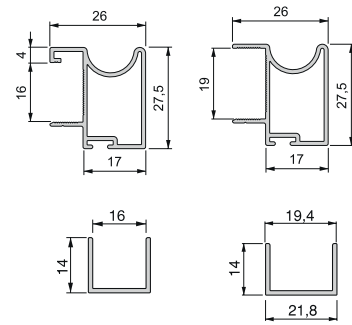

Set de maniglie Sharp 16, 18 e 19 per una porta scorrevole
Satz Sharp Griffe 16, 18 und 19 für eine Schiebetür

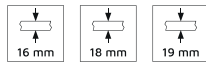

Spessore pannello/Plattendicke	Lunghezza/Längengrad	Finitura/Fertigstellung	Imballaggio/Verpackung	Cod.
16	2,7 m	Verniciato bianco/Weiß	1 KIT/SET	6311012
19	2,7 m	Verniciato bianco/Weiß	1 KIT/SET	6311212
19	2,35 m	Verniciato bianco/Weiß	1 KIT/SET	6308512
16	2,7 m	Verniciato nero/Schwarz	1 KIT/SET	6311014
19	2,35 m	Verniciato nero/Schwarz	1 KIT/SET	6308514
19	2,7 m	Verniciato nero/Schwarz	1 KIT/SET	6311214
18	2,9 m	Anodizzato opaco/Matt eloxiert	1 KIT/SET	6311162
19	2,7 m	Anodizzato opaco/Matt eloxiert	1 KIT/SET	6311262

Alluminio/Aluminium

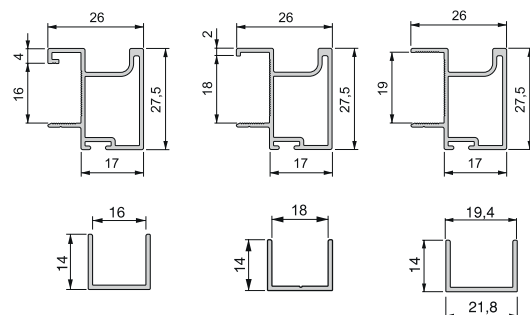

Scorrevoli Schiebesysteme



Calcolo misura anta Untere und Obere Schienen



PLACARD 74

Binari inferiori e superiori Berechnung der Abmessungen der Tür

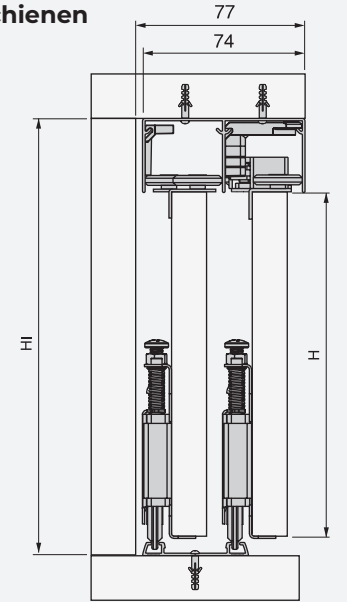
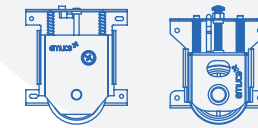
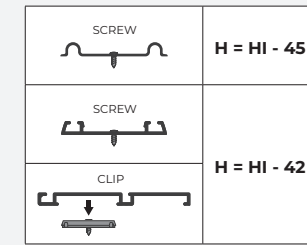
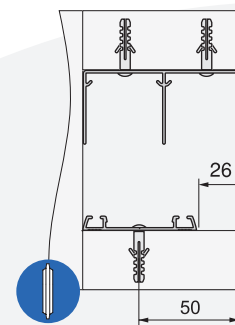
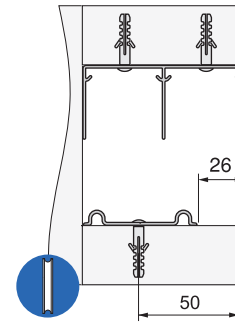

Larghezza minima della porta con Slowmove Minimale Türbreite mit Slowmove

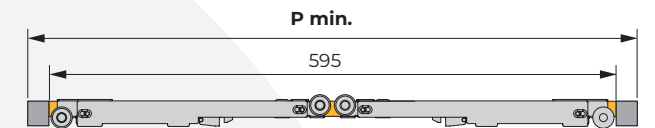

	Wave 16	Sharp 16	Style 16	Wave 18	Sharp 18	Wave 19	Sharp 19
P min.	634 mm	634 mm	642 mm	634 mm	634 mm	634 mm	634 mm

Maniglie Griffe



	1 Ante / Tür		2-3 Ante / Türen	
Wave	$T = \frac{A - 50}{2}$	$P = \frac{A + 18}{2}$	$T = \frac{A - 66}{3}$	$P = \frac{A + 35}{3}$
Sharp	$T = \frac{A - 12}{2}$	$P = \frac{A + 12}{2}$	$T = \frac{A - 12}{3}$	$P = \frac{A + 24}{3}$

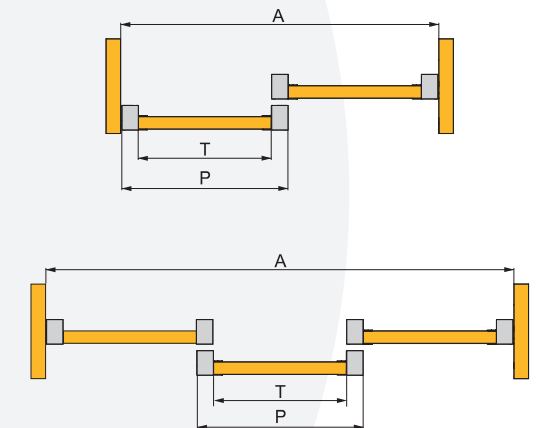

Placard 81

· Utilizzabile per 2 e 3 ante.
Scorrimento su cuscinetti a sfera.
Pattino inferiore regolabile in altezza $\pm 7,5$ mm con freni o ± 5 mm con Soft.
Sistema di anti scarrellamento mediante molla nel pattino inferiore.
Dispone di meccanismo di blocco della molla del pattino inferiore che facilita la installazione delle ante.
Chiusura soft in apertura e chiusura su 2 ante.
Freno superiore che permette comunque l'apertura in entrambi i lati della anta.

· Für 2 und 3 Türen anwendbar.
Mit Kugellager.
Höhenverstellbares Fahrwerk $\pm 7,5$ mm mit Bremsen oder ± 5 mm mit Soft.
Anti-Entgleisungssystem durch Feder an der unteren Schiene und einstellbarer Anti-Sprung-Stopper an den oberen Rollen.
Es verfügt über Verriegelungsmechanismen für die untere Feder der Schiene, die die Installation der Türen erleichtern.
Sanftes Schließen beim Öffnen und Schließen in 2 Türen.
Oberer Stopper, der das Öffnen in beide Richtungen ermöglicht.

Placard 81 set di chiusura morbida per una porta scorrevole Placard 81 Dämpfungssatz für eine Schiebetür

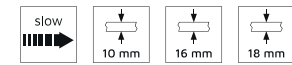

Portata/Belastung	Spessore pannello/Platten-dicke	Finitura/Fertigstellung	Imballaggio/Verpackung	Cod.
30 Kg	10-16	Non classificata/Nicht bestimmt	<input type="checkbox"/> 2 UN/Einh	6107420
30 Kg	18	Non classificata/Nicht bestimmt	<input type="checkbox"/> 2 UN/Einh	6107520
50 Kg	10 - 16	Non classificata/Nicht bestimmt	<input type="checkbox"/> 2 UN/Einh	6107720
50 Kg	18	Non classificata/Nicht bestimmt	<input type="checkbox"/> 2 UN/Einh	6107820

Tecnoplastica/Kunststoff



Set di carrelli Placard con ruota Ø45 per 1 anta scorrevole fino a 70kg per ammortizzatori Beschlagsatz Placard mit Rad Ø45 für 1 Schiebetür 70kg für Softclosing

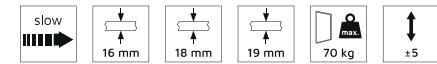

Modello/Modell	Finitura/Fertigstellung	Imballaggio/Verpackung	Cod.
Canale/Rille	Non classificata/Nicht bestimmt <input type="checkbox"/>	4 KIT/SET	6188720

Acciaio, Tecnoplastica/Kunststoff, Stahl



Set di carrelli Placard con ruota Ø50 per 1 anta scorrevole fino a 70kg per ammortizzatori Beschlagsatz Placard mit Rad Ø50 für 1 Schiebetür 70kg für Softclosing

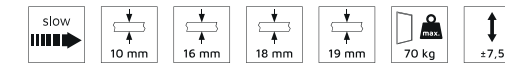

Modello/Modell	Finitura/Fertigstellung	Imballaggio/Verpackung	Cod.
Canale/Rille	Non classificata/Nicht bestimmt <input type="checkbox"/>	4 KIT/SET	6108020
Classico/Klassisch	Non classificata/Nicht bestimmt <input type="checkbox"/>	4 KIT/SET	6108120

Acciaio, Tecnoplastica/Kunststoff, Stahl

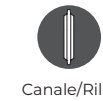

Canale/Rille



Classico/Klassisch

Set di carrelli Placard con ruote Ø50 per una porta scorrevole fino a 70 kg con freno Placard-Wagen-Set mit Rad Ø50 für eine Schiebetür bis 70kg mit Bremse

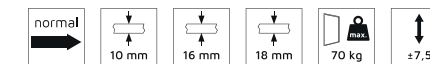

Spessore pannello/Platten-dicke	Modello/Modell	Finitura/Fertigstellung	Imballaggio/Verpackung	Cod.
10-16	Canale/Rille	Non classificata/Nicht bestimmt <input type="checkbox"/>	4 KIT/SET	7004520
10-16	Canale/Rille	Non classificata/Nicht bestimmt <input type="checkbox"/>	4 KIT/SET	7004620
18	Canale/Rille	Non classificata/Nicht bestimmt <input type="checkbox"/>	4 KIT/SET	7917820
10-16	Classico/Klassisch	Non classificata/Nicht bestimmt <input type="checkbox"/>	4 KIT/SET	6009920

Acciaio, Tecnoplastica, Zama/Kunststoff, Stahl, Zamak



Canale/Rille



Classico/Klassisch

Carrello inferiore Placard con ruota Ø45
Laufrollen Placard für Schiebetürsysteme Ø45

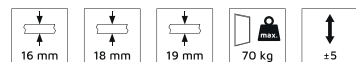

Modello/Modell	Finitura/Fertigstellung	Imballaggio/Verpackung	Cod.
Canale/Rille	Zincato bianco/Verzinkt	50 UN/Einh	6188605

Acciaio, Tecnoplastica/Kunststoff, Stahl

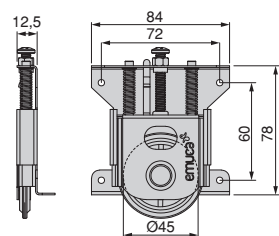

Carrello inferiore Placard con ruota Ø50
Laufrollen Placard für Schiebetürsysteme Ø50

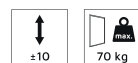

Modello/Modell	Finitura/Fertigstellung	Imballaggio/Verpackung	Cod.
Classico/Klassisch	Verniciato nero/Schwarz	50 UN/Einh	6012214
Canale/Rille	Verniciato nero/Schwarz	50 UN/Einh	6102114

Acciaio, Tecnoplastica/Kunststoff, Stahl

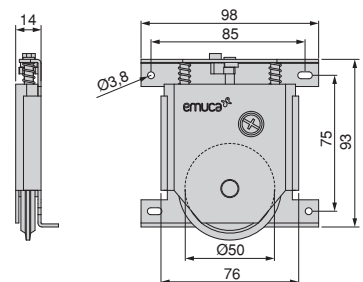

Pattino Placard per porte scorrevoli
Placard Rollen für Schiebetürsysteme

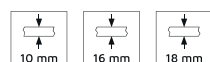

Spessore pannello/Plattendicke	Finitura/Fertigstellung	Imballaggio/Verpackung	Cod.
10-16	Zincato bianco/Verzinkt	100 UN/Einh	6101905
18	Zincato bianco/Verzinkt	100 UN/Einh	6102205

Acciaio, Tecnoplastica/Kunststoff, Stahl



Freno Placard per porte scorrevoli
Placard-Stopper für Schiebetürsysteme

Finitura/Fertigstellung	Imballaggio/Verpackung	Cod.
Grigia/Grau	100 UN/Einh	6102021

Tecnoplastica/Kunststoff



KITS

I kit Placard comprendono tutta la ferramenta necessaria per assemblare un armadio a due ante, ad eccezione dei pannelli.

Die Placard Kits enthalten alle für die Montage eines zweitürigen Kleiderschranks erforderlichen Teile, mit Ausnahme der Paneele.



*Etichetta marcata sulla confezione in formato Kit.

*Etikett auf der Verpackung im Kit-Format.

Binari superiori Placard Classico et Placard a Canale per porte scorrevoli
Obere Schiene für beide Placard Unterschiene für Schiebetürsysteme

normal	10 mm	16 mm	18 mm	Lunghezza/Längengrad	Finitura/Fertigstellung	Imballaggio/Verpackung	Cod.
				3,9 m	Verniciato bianco/Weiß	8 UN/Einh	6907612
				2,35 m	Anodizzato opaco/Matt eloxiert	8 UN/Einh	6301362
				3,9 m	Anodizzato opaco/Matt eloxiert	8 UN/Einh	6907662

Alluminio/Aluminium

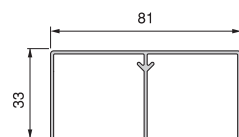

Binario superiore per Slowmove
Placard obere Laufschiene für Slowmove

slow	10 mm	16 mm	18 mm	Lunghezza/Längengrad	Finitura/Fertigstellung	Imballaggio/Verpackung	Cod.
				2,35 m	Verniciato bianco/Weiß	8 UN/Einh	6300912
				3,9 m	Verniciato bianco/Weiß	8 UN/Einh	6118212
				2,35 m	Anodizzato opaco/Matt eloxiert	8 UN/Einh	6300962
				3,9 m	Anodizzato opaco/Matt eloxiert	8 UN/Einh	6118262

Alluminio/Aluminium

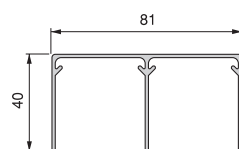

Binario inferiore Placard Classico per porte scorrevoli
Untere Schiene Placard "Classico" für Schiebetürsysteme

10 mm	16 mm	18 mm	Lunghezza/Längengrad	Finitura/Fertigstellung	Imballaggio/Verpackung	Cod.
			2,35 m	Anodizzato opaco/Matt eloxiert	8 UN/Einh	6304662

Alluminio/Aluminium

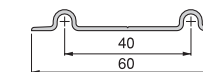

Profilo tappo Placard a Canale per porte scorrevoli
Profil Abdeckkappe Placard für Schiebetürsysteme

10 mm	16 mm	18 mm	19 mm	Lunghezza/Längengrad	Finitura/Fertigstellung	Imballaggio/Verpackung	Cod.
				2,35 m	Anodizzato opaco/Matt eloxiert	16 UN/Einh	6104262
				3,9 m	Anodizzato opaco/Matt eloxiert	16 UN/Einh	6907962

Alluminio/Aluminium

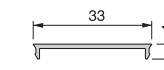

Binario inferiore Placard a Canale per porte scorrevoli
Untere Laufschiene Placard für Schiebetürsysteme

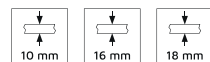

Lunghezza/Längengrad	Finitura/Fertigstellung	Imballaggio/Verpackung	Cod.
2,35 m	Verniciato bianco/Weiß	8 UN/Einh	6307112
3,9 m	Verniciato bianco/Weiß	8 UN/Einh	6907812
2,35 m	Anodizzato opaco/Matt eloxiert	8 UN/Einh	6307162
3,9 m	Anodizzato opaco/Matt eloxiert	8 UN/Einh	6907862

Alluminio/Aluminium

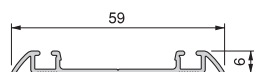

Binario inferiore Placard a Canale Clip
Placard untere versenkte Laufschiene mit Clip

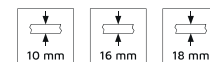

Lunghezza/Längengrad	Finitura/Fertigstellung	Imballaggio/Verpackung	Cod.
3,9 m	Anodizzato opaco/Matt eloxiert	8 UN/Einh	6907562

Alluminio/Aluminium

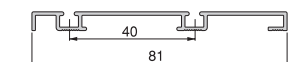
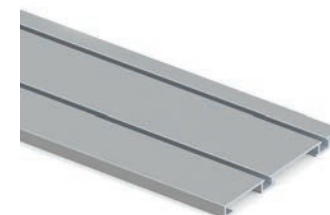

Binario inferiore Placard a Canale Clip per porte scorrevoli
Untere Laufschiene Placard Clip für Schiebetürsysteme

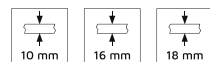

Lunghezza/Längengrad	Finitura/Fertigstellung	Imballaggio/Verpackung	Cod.
2,35 m	Anodizzato opaco/Matt eloxiert	8 UN/Einh	6304962
3,9 m	Anodizzato opaco/Matt eloxiert	8 UN/Einh	6032162

Alluminio/Aluminium

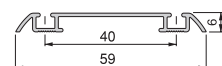

Clip per porte scorrevoli Placard
Clip für Schienen Placard für Schiebetürsysteme

Finitura/Fertigstellung	Imballaggio/Verpackung	Cod.
Nera/Schwarzer	25 UN/Einh	6009017

Tecnoplastica/Kunststoff

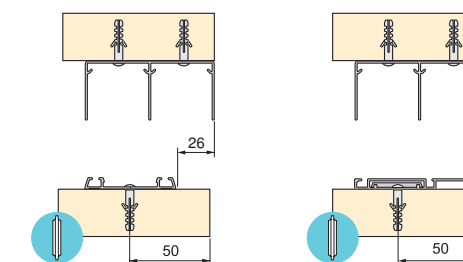
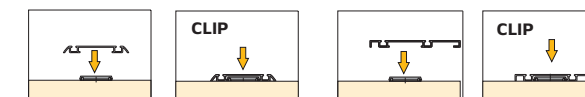

Maniglia per armadio Style 10
Griff für Schiebetüren Style 10



Lunghezza/Längengrad	Finitura/Fertigstellung	Imballaggio/Verpackung	Cod.
2,7 m	Verniciato bianco/Weiß	8 UN/Einh	7005612
2,7 m	Anodizzato opaco/Matt eloxiert	8 UN/Einh	7005662

Alluminio/Aluminium

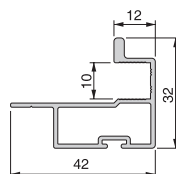

Maniglia per armadio Wave 16
Griff für Schiebetüren Wave 16



Lunghezza/Längengrad	Finitura/Fertigstellung	Imballaggio/Verpackung	Cod.
2,35 m	Verniciato bianco/Weiß	8 UN/Einh	6302412
2,7 m	Verniciato bianco/Weiß	8 UN/Einh	7005412
2,35 m	Anodizzato opaco/Matt eloxiert	8 UN/Einh	6302462
2,7 m	Anodizzato opaco/Matt eloxiert	8 UN/Einh	7005462

Alluminio/Aluminium

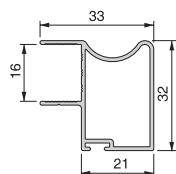

Maniglia per armadio Wave 16E con profilo sottile
Schmaler Profilschrankhalter Wave 16E



Spessore pannello/Platten- dicke	Lunghezza/Längengrad	Finitura/Fertigstellung	Imballaggio/Verpackung	Cod.
16 mm	2,8 m	Anodizzato opaco/Matt eloxiert	8 UN/Einh	6031762

Alluminio/Aluminium

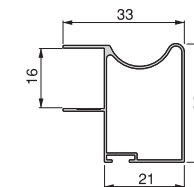

Maniglia per armadio Sharp 16
Griff für Schiebetüren Sharp 16



Lunghezza/Längengrad	Finitura/Fertigstellung	Imballaggio/Verpackung	Cod.
2,35 m	Anodizzato opaco/Matt eloxiert	8 UN/Einh	6303762
2,7 m	Anodizzato opaco/Matt eloxiert	8 UN/Einh	6013562

Alluminio/Aluminium

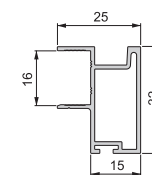

Maniglia per armadio Wave 18
Griff für Schiebetüren Wave 18



Lunghezza/Längengrad	Finitura/Fertigstellung	Imballaggio/Verpackung	Cod.
2,35 m	Anodizzato opaco/Matt eloxiert	8 UN/Einh	7014762
2,5 m	Anodizzato opaco/Matt eloxiert	8 UN/Einh	7017762
2,9 m	Anodizzato opaco/Matt eloxiert	8 UN/Einh	7917362

Alluminio/Aluminium

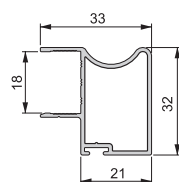

Maniglia per armadio Wave 18E con profilo sottile
Schmaler Profilschrankhalter Wave 18E



Spessore pannello/Plattendicke	Lunghezza/Längengrad	Finitura/Fertigstellung	Imballaggio/Verpackung	Cod.
18 mm	2,8 m	Anodizzato opaco/Matt eloxiert	8 UN/Einh	6031562

Alluminio/Aluminium

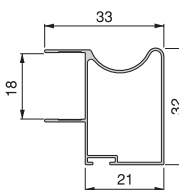
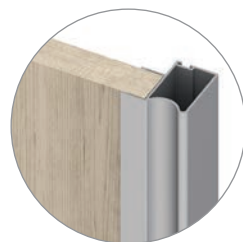
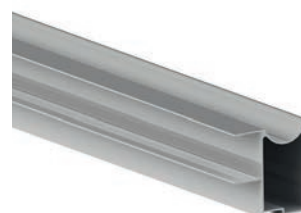

Maniglia per armadio Deep 18
Griff für Schiebetüren Deep 18



Lunghezza/Längengrad	Finitura/Fertigstellung	Imballaggio/Verpackung	Cod.
2,35 m	Anodizzato opaco/Matt eloxiert	8 UN/Einh	6303962
2,5 m	Anodizzato opaco/Matt eloxiert	8 UN/Einh	6018162
2,9 m	Anodizzato opaco/Matt eloxiert	8 UN/Einh	6018262

Alluminio/Aluminium

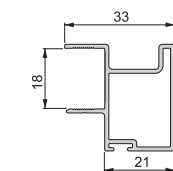
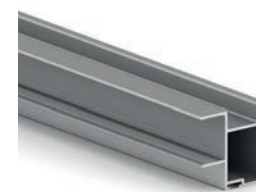

Maniglia per armadio Sharp 18E con profilo sottile
Schmaler Profilschrankhalter Sharp 18E



Spessore pannello/Plattendicke	Lunghezza/Längengrad	Finitura/Fertigstellung	Imballaggio/Verpackung	Cod.
18 mm	2,8 m	Anodizzato opaco/Matt eloxiert	8 UN/Einh	6031662

Alluminio/Aluminium

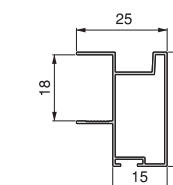

Maniglia per armadio Quad 18
Griff für Schiebetüren Quad 18



Lunghezza/Längengrad	Finitura/Fertigstellung	Imballaggio/Verpackung	Cod.
2,9 m	Anodizzato opaco/Matt eloxiert	8 UN/Einh	7918962

Alluminio/Aluminium

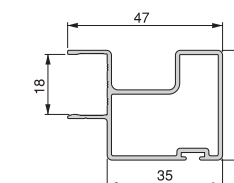
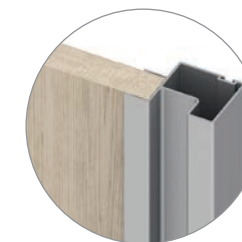

Traverso Placard H16x18
 Querbalken Placard H16x18



Lunghezza/Längengrad	Finitura/Fertigstellung	Imballaggio/Verpackung	Cod.
2,35 m	Verniciato bianco/Weiß	8 UN/Einh	6300812
2,35 m	Anodizzato opaco/Matt eloxiert	8 UN/Einh	6300862

Alluminio/Aluminium

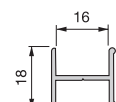

Traversa Placard H16Ex12/22 con profilo sottile
 Querträger Placard H16Ex12/22, dünnes Profil



Spessore pannello/Plattendicke	Lunghezza/Längengrad	Finitura/Fertigstellung	Imballaggio/Verpackung	Cod.
16 mm	2,8 m	Anodizzato opaco/Matt eloxiert	8 UN/Einh	6031862

Alluminio/Aluminium

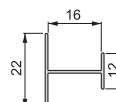

Traverso Placard H18x12/22
 Querbalken Placard H18x12/22



Lunghezza/Längengrad	Finitura/Fertigstellung	Imballaggio/Verpackung	Cod.
2,35 m	Anodizzato opaco/Matt eloxiert	8 UN/Einh	6305662

Alluminio/Aluminio

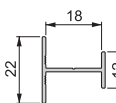

Traverso Placard U10x16
 Querbalken Placard U10x16



Lunghezza/Längengrad	Finitura/Fertigstellung	Imballaggio/Verpackung	Cod.
2,35 m	Verniciato bianco/Weiß	8 UN/Einh	6302712
2,35 m	Anodizzato opaco/Matt eloxiert	8 UN/Einh	6302762

Alluminio/Aluminium

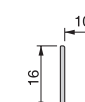

Traverso Placard U16x14
 Querbalken Placard U16x14



Lunghezza/Längengrad	Finitura/Fertigstellung	Imballaggio/Verpackung	Cod.
2,35 m	Verniciato bianco/Weiß	8 UN/Einh	6300312
2,35 m	Anodizzato opaco/Matt eloxiert	8 UN/Einh	6300362

Alluminio/Aluminium



Traverso Placard U18x14
 Querbalken Placard U18x14



Lunghezza/Längengrad	Finitura/Fertigstellung	Imballaggio/Verpackung	Cod.
2,35 m	Anodizzato opaco/Matt eloxiert	8 UN/Einh	6305762

Alluminio/Aluminium



Sistema scorrevole per armadio 2 ante a scorrimento inferiore Placard con profili Wave e chiusura soft
Schiebetürensysteem für Schrank mit 2 Türen Laufrollen untere Schiene Placard mit Profilen Wave und sanftem Schließen

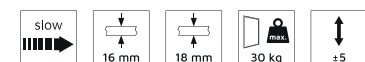

Spessore pannello/Plattendicke	Finitura/Fertigstellung	Imballaggio/Verpackung	Cod.
16	Anodizzato opaco/Matt eloxiert	1 KIT/SET	6030362
18	Anodizzato opaco/Matt eloxiert	1 KIT/SET	6030462

Acciaio, Alluminio, Tecnoplastica/Aluminium, Kunststoff, Stahl



KITS

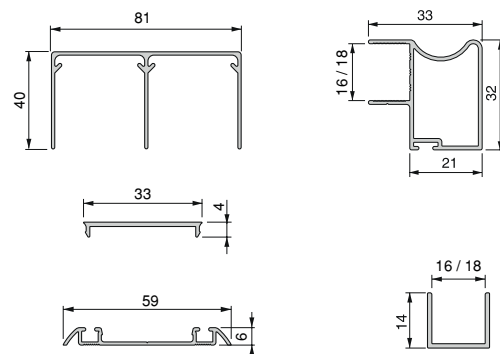

Le binari e i profili superiori e inferiori sono forniti in una dimensione di 2.350 mm.

Die oberen und unteren Schienen und Profile werden in einer Abmessung von 2.350 mm geliefert.

Sistema scorrevole per armadio 2 ante a scorrimento inferiore Placard con profili Sharp e chiusura soft
Schiebetürensysteem für Schrank mit 2 Türen Laufrollen untere Schiene Placard mit Profilen Sharp und sanftem Schließen

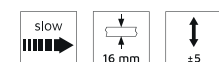

Spessore pannello/Plattendicke	Finitura/Fertigstellung	Imballaggio/Verpackung	Cod.
16	Anodizzato opaco/Matt eloxiert	1 KIT/SET	6030762

Acciaio, Alluminio, Tecnoplastica/Aluminium, Kunststoff, Stahl



KITS

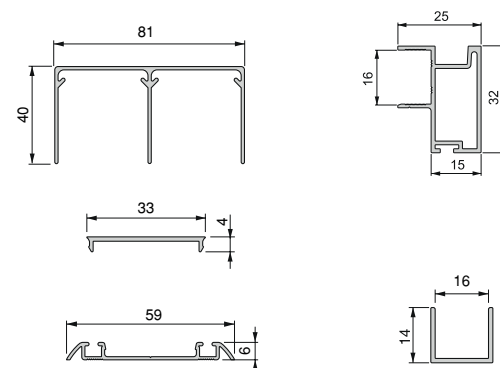

Le binari e i profili superiori e inferiori sono forniti in una dimensione di 2.350 mm.

Die oberen und unteren Schienen und Profile werden in einer Abmessung von 2.350 mm geliefert.

Sistema scorrevole per armadio 2 ante a scorrimento inferiore Placard con profili Deep e chiusura soft
Schiebetürensysteem für Schrank mit 2 Türen Laufrollen untere Schiene Placard mit Profilen Deep und sanftem Schließen

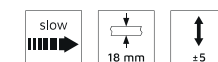

Spessore pannello/Plattendicke	Finitura/Fertigstellung	Imballaggio/Verpackung	Cod.
18	Anodizzato opaco/Matt eloxiert	1 KIT/SET	6030862

Acciaio, Alluminio, Tecnoplastica/Aluminium, Kunststoff, Stahl



KITS

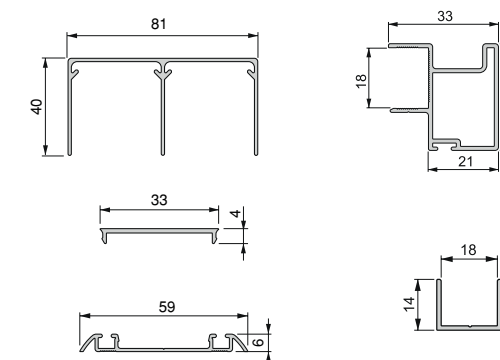

Le binari e i profili superiori e inferiori sono forniti in una dimensione di 2.350 mm.

Die oberen und unteren Schienen und Profile werden in einer Abmessung von 2.350 mm geliefert.

Set di binari per Placard a Canale
Placard Laufschiensatz



Descrizioni/Beschreibung	Lunghezza/Längengrad	Finitura/Fertigstellung	Imballaggio/Verpackung	Cod.
Binario superiore 81x33/ Obere Schiene 81x33	3,9 m	Anodizzato opaco/Matt eloxiert	1 UN/Einh	6032462
Binario superiore Soft 81x40/Obere Schiene Soft 81x40	2,35 m	Anodizzato opaco/Matt eloxiert	1 UN/Einh	6309162
Binario superiore Soft 81x40/Obere Schiene Soft 81x40	3,9 m	Anodizzato opaco/Matt eloxiert	1 UN/Einh	6901162

Alluminio/Aluminium

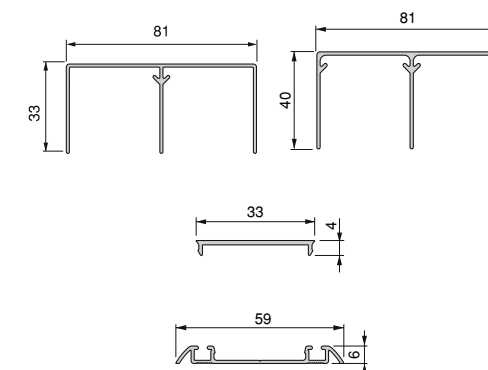

Set de maniglie Style 10 per una porta scorrevole
 Satz Style Griffe 10 für eine Schiebetür

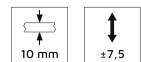

Lunghezza/Längengrad	Finitura/Fertigstellung	Imballaggio/Verpackung	Cod.
2,7 m	Verniciato bianco/Weiß	1 KIT/SET	7012012
2,7 m	Anodizzato opaco/Matt eloxiert	1 KIT/SET	7012062

Alluminio, Vari/Aluminium, Verschiedene



Set de maniglie Wave 16 per una porta scorrevole
 Satz Wave Griffe 16 für eine Schiebetür

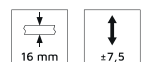

Lunghezza/Längengrad	Finitura/Fertigstellung	Imballaggio/Verpackung	Cod.
2,7 m	Anodizzato opaco/Matt eloxiert	1 KIT/SET	7006462

Alluminio, Vari/Aluminium, Verschiedene



Set de maniglie Deep 18 per una porta scorrevole
 Satz Deep Griffe 18 für eine Schiebetür

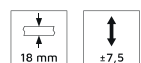

Spessore pannello/Platten- dicke	Lunghezza/Längengrad	Finitura/Fertigstellung	Imballaggio/Verpackung	Cod.
18	2,9 m	Anodizzato opaco/Matt eloxiert	1 KIT/SET	6311562

Alluminio/Aluminium



Placard





PLACARD 81

Binari inferiori e superiori
Berechnung der Abmessungen der Tür

Modello	X	Y
	20	49,5
	22	51,5

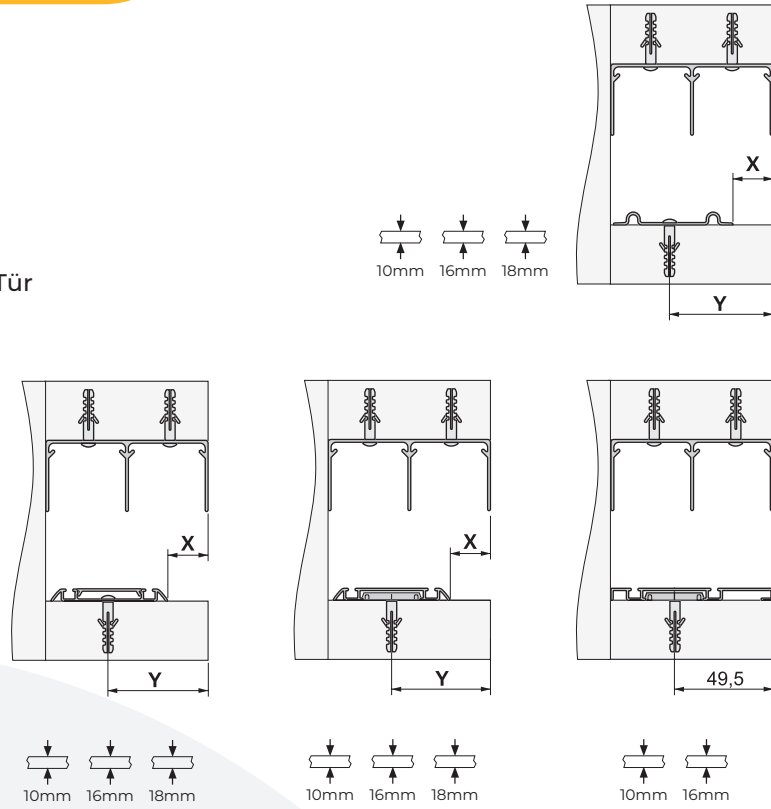

Calcolo misura anta
Untere und Obere Schienen

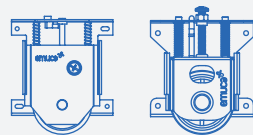

	SCREW	$H = HI - 45$
	SCREW	$H = HI - 42$
	CLIP	
	CLIP	

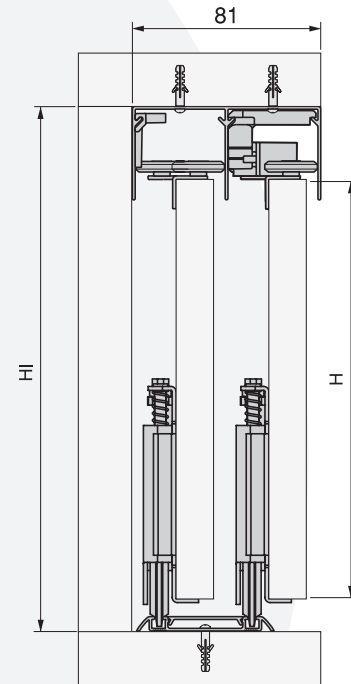

Larghezza minima della porta con Slowmove
Minimale Türbreite mit Slowmove

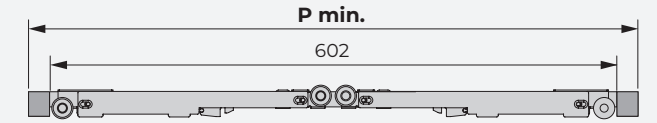

P min.	656 mm	674 mm	656 mm	640 mm	684 mm	656 mm	656 mm	684 mm

Maniglie
Griffe

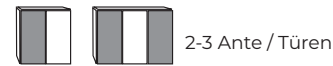
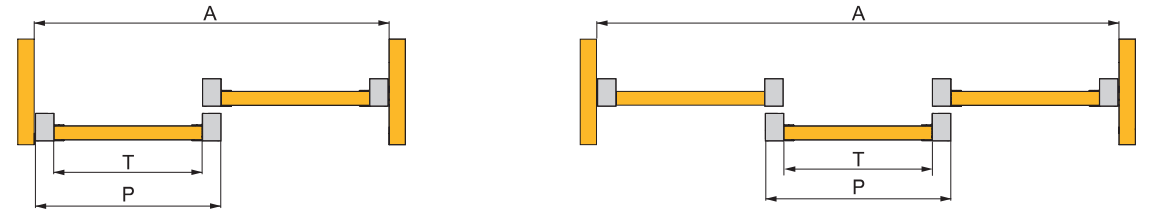

Wave	$T = \frac{A - 64}{2}$	$p = \frac{A + 20}{2}$	$T = \frac{A - 86}{3}$ $p = \frac{A + 40}{3}$
Style	$T = \frac{A + 16}{2}$	$p = \frac{A + 22}{2}$	$T = \frac{A + 35}{3}$ $p = \frac{A + 44}{3}$
Sharp	$T = \frac{A - 45}{2}$	$p = \frac{A + 15}{2}$	$T = \frac{A - 60}{3}$ $p = \frac{A + 15}{3}$
Quad	$T = \frac{A - 105}{2}$	$p = \frac{A + 35}{2}$	$T = \frac{A - 140}{3}$ $p = \frac{A + 70}{3}$
Deep	$T = \frac{A - 64}{2}$	$p = \frac{A + 20}{2}$	$T = \frac{A - 86}{3}$ $p = \frac{A + 40}{3}$

Placard 74 / 81



Placard 81 / Placard 81 PORTA CRISTALLO PLACARD 81 / GLASTÜR PLACARD 81



Profilo superiore e inferiore 12+4 per porte scorrevoli in vetro
Oberes und unteres Profil 12+4 für Glasschiebetürsysteme



Spessore pannello/Platten- dicke	Lunghezza/Längengrad	Finitura/Fertigstellung	Imballaggio/Verpackung	Cod.
16	2,35 m	Anodizzato opaco/Matt eloxiert	8 UN/Einh	6303262

Alluminio/Aluminium

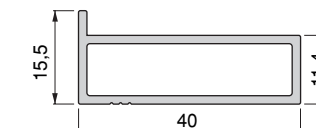
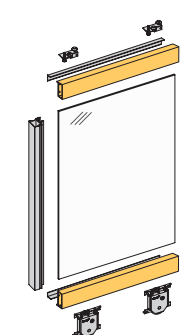

Profilo per la realizzazione di ante per armadi Plus 14 (14+4)
Profil für die Herstellung von Schranktüren Plus 14 (14+4)



Lunghezza/Längengrad	Finitura/Fertigstellung	Imballaggio/Verpackung	Cod.
2,35 m	Anodizzato opaco/Matt eloxiert	8 UN/Einh	6304462

Alluminio/Aluminium

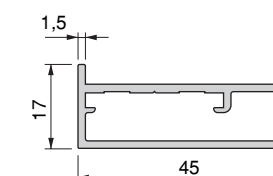
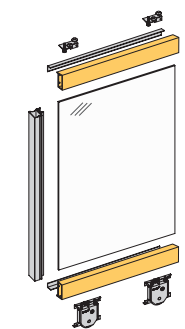

Ferramenta Placard Cristallo 6+4 e 12+4 per porte scorrevoli
 Placard Beschläge für Glasschiebetüren 6+4 und 12+4

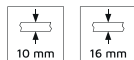

Finitura/Fertigstellung	Imballaggio/Verpackung	Cod.
Non classificata/Nicht bestimmt	1 KIT/SET	6006920

Vari/Verschiedene

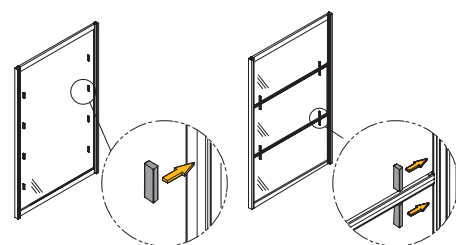

Profilo superiore e inferiore per porte scorrevoli in vetro
 Oberes und unteres Profil für Glasschiebetürsysteme

Lunghezza/Längengrad	Finitura/Fertigstellung	Imballaggio/Verpackung	Cod.
2,35 m	Anodizzato opaco/Matt eloxiert	20 UN/Einh	6303362

Alluminio/Aluminium

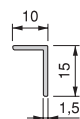
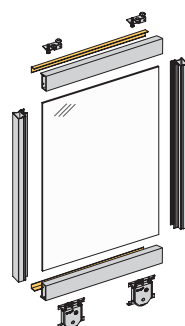

Guarnizione profilo Placard per cristallo
 Placard Trimmprofil für Glastüren

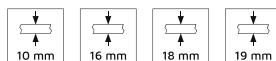

A	B	Spessore pannello/ Plattendicke	Lunghezza/Län- gengrad	Finitura/Fertigstellung	Imballaggio/Ver- packung	Cod.
12	6	10-16	32 m	Grigia/Grau	1 UN/Einh	4001621
14	10	18 - 19	32 m	Grigia/Grau	1 UN/Einh	7917121

Tecnoplastica/Kunststoff

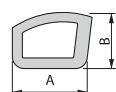

Placard



Placard 90

Utilizzabile per 2 e 3 ante.
Scorrimento su cuscinetti a sfera.
Pattino inferiore regolabile in altezza $\pm 7,5$ mm con freni o ± 5 mm con Soft.
Sistema di anti scarrellamento mediante molla nel pattino inferiore.
Dispone di meccanismo di blocco della molla del pattino inferiore che facilita la installazione delle ante.
Chiusura soft in apertura e chiusura su 2 ante.
Freno superiore che permette comunque l'apertura in entrambi i lati della anta.

Für 2 und 3 Türen anwendbar.
Mit Kugellager.
Höhenverstellbares Fahrwerk $\pm 7,5$ mm mit Bremsen oder ± 5 mm mit Soft.
Anti-Entgleisungssystem durch Feder an der unteren Schiene und einstellbarer Anti-Sprung-Stopper an den oberen Rollen.
Es verfügt über Verriegelungsmechanismen für die untere Feder der Schiene, die die Installation der Türen erleichtern.
Sanftes Schließen beim Öffnen und Schließen in 2 Türen.
Oberer Stopper, der das Öffnen in beide Richtungen ermöglicht.

Set di ferramenta per anta con Slowmove (Ammortizzatori) Beschläge für eine Tür, sanftes Schließen

Portata/Belastung	Spessore pannello/Platten-dicke	Finitura/Fertigstellung	Imballaggio/Verpackung	Cod.
30 Kg	19	Non classificata/Nicht bestimmt	2 UN/Einh	6107620
50 Kg	19	Non classificata/Nicht bestimmt	2 UN/Einh	6107920

Tecnoplastica/Kunststoff



Set di carrelli Placard con ruota Ø45 per 1 anta scorrevole fino a 70kg per ammortizzatori Beschlagsatz Placard mit Rad Ø45 für 1 Schiebetür 70kg für Softclosing

Modello/Modell	Finitura/Fertigstellung	Imballaggio/Verpackung	Cod.
Canale/Rille	Non classificata/Nicht bestimmt	4 KIT/SET	6188720

Acciaio, Tecnoplastica/Kunststoff, Stahl



Ferramenta per una porta a Canale scorrevole Beschläge für eine Schiebetür

Spessore pannello/Plattendicke	Finitura/Fertigstellung	Imballaggio/Verpackung	Cod.
19 mm	Non classificata/Nicht bestimmt	4 KIT/SET	6104520

Acciaio, Tecnoplastica/Kunststoff, Stahl



Set di carrelli Placard con ruota Ø50 per 1 anta scorrevole fino a 70kg per ammortizzatori Beschlagsatz Placard mit Rad Ø50 für 1 Schiebetür 70kg für Softclosing

Modello/Modell	Finitura/Fertigstellung	Imballaggio/Verpackung	Cod.
Canale/Rille	Non classificata/Nicht bestimmt	4 KIT/SET	6108020
Classico/Klassisch	Non classificata/Nicht bestimmt	4 KIT/SET	6108120

Acciaio, Tecnoplastica/Kunststoff, Stahl



Carrello inferiore Placard con ruota Ø45 Laufrollen Placard für Schiebetürsysteme Ø45

Modello/Modell	Finitura/Fertigstellung	Imballaggio/Verpackung	Cod.
Canale/Rille	Zincato bianco/Verzinkt	50 UN/Einh	6188605

Acciaio, Tecnoplastica/Kunststoff, Stahl

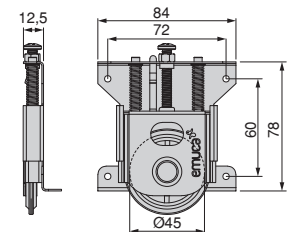

Carrello inferiore Placard con ruota Ø50
Laufrollen Placard für Schiebetürsysteme Ø50



Modello/Modell	Finitura/Fertigstellung	Imballaggio/Verpackung	Cod.
Canale/Rille	Verniciato nero/Schwarz	50 UN/Einh	6102114

Acciaio, Tecnoplastica/Kunststoff, Stahl

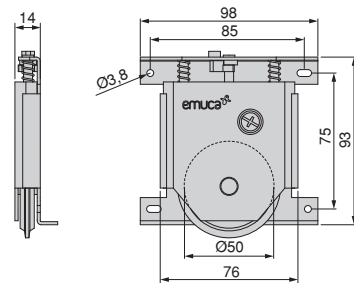

Pattino Placard per porte scorrevoli
Placard Rollen für Schiebetürsysteme



Spessore pannello/Plattendicke	Finitura/Fertigstellung	Imballaggio/Verpackung	Cod.
19 mm	Zincato bianco/Verzinkt	100 UN/Einh	6102605

Acciaio, Tecnoplastica/Kunststoff, Stahl



Freno Placard per porte scorrevoli
Placard-Stopper für Schiebetürsysteme

Finitura/Fertigstellung	Imballaggio/Verpackung	Cod.
Grigia/Grau	100 UN/Einh	6102021

Tecnoplastica/Kunststoff



Binario superiore per Slowmove
Placard obere Laufschiene für Slowmove



Lunghezza/Längengrad	Finitura/Fertigstellung	Imballaggio/Verpackung	Cod.
2,35 m	Anodizzato opaco/Matt eloxiert	8 UN/Einh	6306262
3,9 m	Anodizzato opaco/Matt eloxiert	8 UN/Einh	6032262

Alluminio/Aluminium

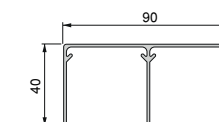

Binario inferiore Placard a Canale per porte scorrevoli
Untere Laufschiene Placard für Schiebetürsysteme



Lunghezza/Längengrad	Finitura/Fertigstellung	Imballaggio/Verpackung	Cod.
2,35 m	Anodizzato opaco/Matt eloxiert	8 UN/Einh	6304062
3,9 m	Anodizzato opaco/Matt eloxiert	8 UN/Einh	6032062

Alluminio/Aluminium

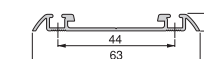

Profilo tappo Placard a Canale per porte scorrevoli
Profil Abdeckkappe Placard für Schiebetürsysteme



Lunghezza/Längengrad	Finitura/Fertigstellung	Imballaggio/Verpackung	Cod.
2,35 m	Anodizzato opaco/Matt eloxiert	16 UN/Einh	6104262
3,9 m	Anodizzato opaco/Matt eloxiert	16 UN/Einh	6907962

Alluminio/Aluminium

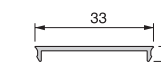

Maniglia per armadio Vall 19
Griff für Schiebetüren Vall 19



Lunghezza/Längengrad	Finitura/Fertigstellung	Imballaggio/Verpackung	Cod.
2,35 m	Anodizzato opaco/Matt eloxiert	8 UN/Einh	6307662
2,7 m	Anodizzato opaco/Matt eloxiert	8 UN/Einh	6016662

Alluminio/Aluminium



Maniglia per armadio Hill 19
Griff für Schiebetüren Hill 19



Lunghezza/Längengrad	Finitura/Fertigstellung	Imballaggio/Verpackung	Cod.
2,7 m	Anodizzato opaco/Matt eloxiert	8 UN/Einh	6016762

Alluminio/Aluminium



Maniglia per armadio Line 19
Griff für Schiebetüren Line 19



Lunghezza/Längengrad	Finitura/Fertigstellung	Imballaggio/Verpackung	Cod.
2,7 m	Anodizzato opaco/Matt eloxiert	8 UN/Einh	6016862

Alluminio/Aluminium



Traverso Placard U19x14
Querbalken Placard U19x14



Lunghezza/Längengrad	Finitura/Fertigstellung	Imballaggio/Verpackung	Cod.
2,35 m	Anodizzato opaco/Matt eloxiert	8 UN/Einh	6103162

Alluminio/Aluminio



Traverso Placard H19x12/22
Querbalken Placard H19x12/22



Lunghezza/Längengrad	Finitura/Fertigstellung	Imballaggio/Verpackung	Cod.
2,35 m	Anodizzato opaco/Matt eloxiert	8 UN/Einh	6102962

Alluminio/Aluminio



Sistema scorrevole per armadio 2 ante a scorrimento inferiore Placard 90 con profili Vall e chiusura soft
Schiebetürensysteem für Schrank mit 2 Türen Laufrollen untere Schiene Placard 90 mit Profilen Vall und sanftem Schließen

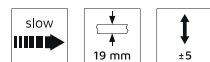

Spessore pannello/Plattendicke	Finitura/Fertigstellung	Imballaggio/Verpackung	Cod.
19	Anodizzato opaco/Matt eloxiert	1 KIT/SET	6030962

Alluminio/Aluminium

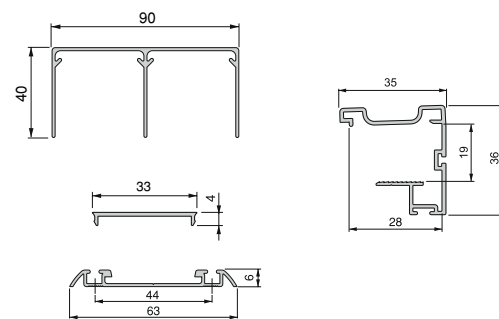

Le binari e i profili superiori e inferiori sono forniti in una dimensione di 2.350 mm.
Die oberen und unteren Schienen und Profile werden in einer Abmessung von 2.350 mm geliefert.

Set di binari per Placard a Canale per porte scorrevole
Satz Schienen für Placard Schiebetüren



Lunghezza/Längengrad	Finitura/Fertigstellung	Imballaggio/Verpackung	Cod.
2,35 m	Anodizzato opaco/Matt eloxiert	1 UN/Einh	6118662
3,9 m	Anodizzato opaco/Matt eloxiert	1 UN/Einh	6032362

Alluminio/Aluminium

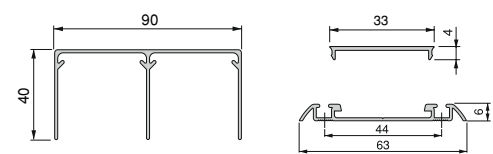

Set de maniglie Hill 19 per una porta scorrevole
Satz Hill Griffe 19 für eine Schiebetür

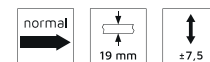

Spessore pannello/Plattendicke	Lunghezza/Längengrad	Finitura/Fertigstellung	Imballaggio/Verpackung	Cod.
19	2,7 m	Anodizzato opaco/Matt eloxiert	1 KIT/SET	6104662

Alluminio, Vari/Aluminium, Verschiedene

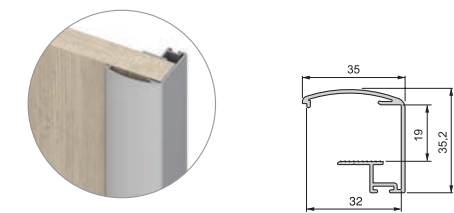
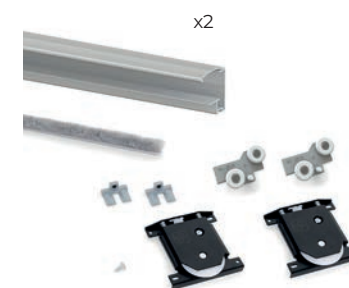

Set de maniglie Line 19 per una porta scorrevole
Satz Line Griffe 19 für eine Schiebetür

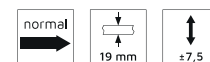

Spessore pannello/Plattendicke	Lunghezza/Längengrad	Finitura/Fertigstellung	Imballaggio/Verpackung	Cod.
19	2,7 m	Anodizzato opaco/Matt eloxiert	1 KIT/SET	6311662

Alluminio/Aluminium

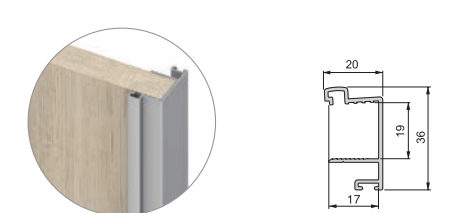

Set de maniglie Vall 19 per una porta scorrevole
Satz Vall Griffe 19 für eine Schiebetür

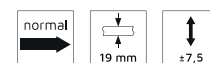

Spessore pannello/Plattendicke	Lunghezza/Längengrad	Finitura/Fertigstellung	Imballaggio/Verpackung	Cod.
19	2,7 m	Anodizzato opaco/Matt eloxiert	1 KIT/SET	6311762

Alluminio/Aluminium

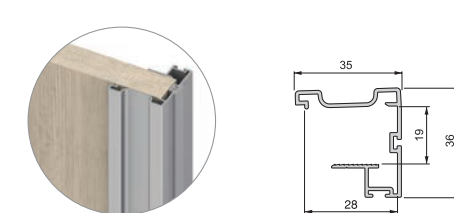



PLACARD 90

Binari inferiori e superiori
Berechnung der Abmessungen der Tür

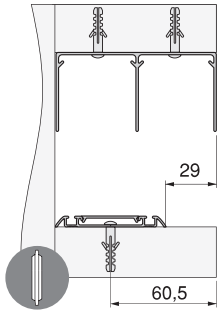

Calcolo misura anta
Untere und Obere Schienen

normal slow

$$H = HI - 42$$

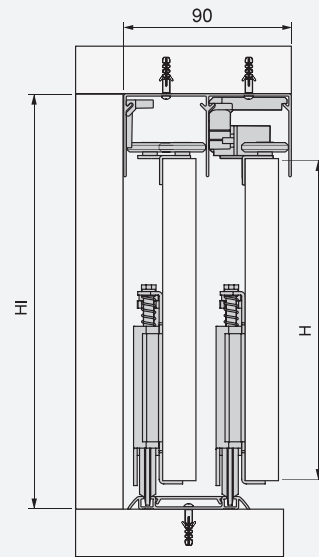
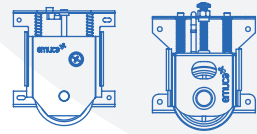

Larghezza minima della porta con Slowmove
Minimale Türbreite mit Slowmove

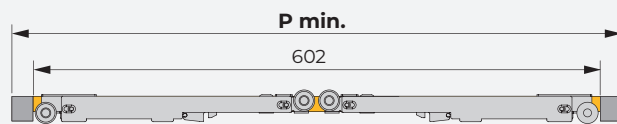

	Vall 19	Hill 19	Line 19
P min.	636 mm	636 mm	628 mm

Maniglie
Griffe



	Single Handle		Double Handle	
Vall	$T = \frac{A + 16}{2}$	$P = \frac{A + 28}{2}$	$T = \frac{A + 42}{3}$	$P = \frac{A + 60}{3}$
Hill	$T = \frac{A + 30}{2}$	$P = \frac{A + 34}{2}$	$T = \frac{A + 62}{3}$	$P = \frac{A + 68}{3}$
Line	$T = \frac{A + 16}{2}$	$P = \frac{A + 20}{2}$	$T = \frac{A + 34}{3}$	$P = \frac{A + 40}{3}$

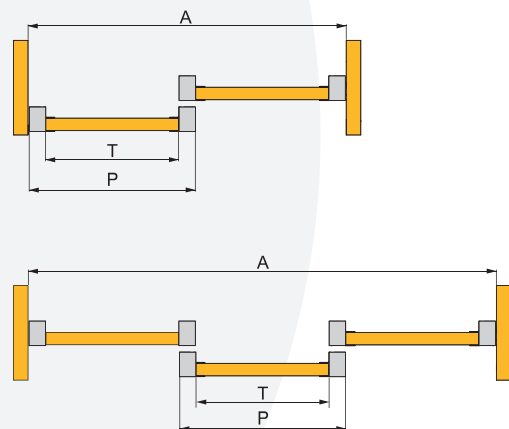

Placard





Emuca S.R.L

Via Messico, 80 · 35127 · Padova (ITALIA)
T. +39 049 8702800 · F. +39 049 87 03019
www.emuca.it

Emuca S.A.

Pl. El Oliveral - c/H, 4 · Apartado de correos 176
46394 · Riba-Roja del Túria · Valencia (ESPAÑA)
T. +34 96 166 70 19 · F. +34 96 166 71 82
www.emuca.es

Emuca Ltd.

75 Springfield Road · Chelmsford · Essex
CM2 6JG (UK)
T. +44 1268 530 674 · F. +44 1268 282 592
www.emuca.co.uk

Emuca S.A.R.L

Parc de l'Aubinière · 2 Avenue des Améthystes
44338 · Nantes Cedex 03 (FRANCE)
T. +33 2 49 88 07 35 · F. +33 2 72 22 02 24
www.emuca.fr

Emuca Lda.

AV. da Liberdade n° 38, 4° · 1250-145 Lisboa (PORTUGAL)
T. +351 211 203 940 · F. +34 96 166 71 82
www.emuca.pt

04/2024

AENOR



Empresa
Registrada
UNE-EN ISO 9001
ER-0896/1999



UNI EN ISO 9001:2015



CERTIQUALITY
È MEMBRO DELLA
FEDERAZIONE CISQ

