

DARK





Dark

4	Vertex drawer	Szuflada Vertex	164	Titane Accessories	Akcesoria Titane
10	Vertex glass	Szkló Vertex	168	Kitchen and bathroom accessories	Akcesoria kuchenne i łazienkowe
22	Vertex interior	Wnętrze Vertex	170	Kitchen accessories	Akcesoria kuchenne
28	Concept drawer	Szuflada koncepcyjna	176	Ironing board	Deska do prasowania
36	Convex drawer	Szuflada wypukła	178	Waste bins	Kosze na śmieci
42	Simplex drawer	Szuflada Simplex	186	Gola profiles	Profile Gola
46	Drawer accessories	Akcesoria do szuflad	192	Gola vertical profile	Profil pionowy Gola
52	Siphon trap saver	Oszczędzacz syfonu	196	Plinths	Cokoły
56	Runners	Prowadnice	198	Module hangers	Wieszaki modułowe
62	Hinges	Zawiasy	204	Shelf supports	Wsporniki półek
76	Catches and hooks	Zaczepty i haki	208	LED luminaires with battery	Oprawy oświetleniowe LED z akumulatorem
82	Push latches	Zatrzaski	210	Illuminated mirrors	Podświetlane lustra
86	Zero modular structure	Modułowa struktura Zero	212	Bathroom luminaires	Oprawy łazienkowe
88	Vertical Zero	Zero pionowe	216	LED wall lights	Lampy ścienne LED
96	Horizontal Zero	Zero poziome	218	Converters	Konwertery
100	Zero brackets	Wsporniki Zero	220	Sensors	Czujniki
102	Zero aluminium shelf	Półka aluminiowa Zero	224	Lynx Profiles	Profile Lynx
104	Luxe Hanging Bar	Drażek do zawieszania Luxe	228	Chargers	Ładowarki
106	Hang and Hack Accessories	Akcesoria do wieszania i hakowania	230	Connectors	Złącza
108	Hanging Hanger	Wieszak wiszący	236	Office accessories	Akcesoria biurowe
112	Hanging tubes	Rurki do wieszania	240	Modern handles	Nowoczesne uchwyty
120	Wall hooks	Haki ścienne	248	Vintage handles	Uchwyty w stylu vintage
122	Hack accessories	Akcesoria do wieszaków	252	Knob handles	Uchwyty z gałką
134	Lader shelving	Półki Lader	256	Square legs	Nóżki kwadratowe
136	Plus Profiles	Profile Plus	258	60° legs	Nogi 60
140	Flow System	System Flow	260	Table legs	Nogi stołowe
146	Barn System	System stodoły	264	Couch bed	Leżanka
148	Placard System	System tabliczek	266	Castors	Kółka
160	Titane System	System Titane			

Vertex Drawer
Szuflada Vertex



3D Vertex 40 kg exterior drawer height 93 mm
 Szuflada zewnętrzna Vertex 3D 40 kg, wysokość 93 mm



Depth/Głębokość	Finishing/Wykończenie	Packaging/Opakowanie	Cod.
350	Anthracite grey/Szary antracyt	1 KIT/Zestaw	3185035
450	Anthracite grey/Szary antracyt	1 KIT/Zestaw	3185135
500	Anthracite grey/Szary antracyt	1 KIT/Zestaw	3185235

Steel/Stal

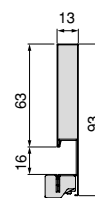
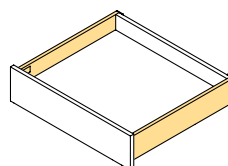

3D Vertex 40 kg exterior drawer height 131 mm
 Szuflada zewnętrzna Vertex 3D 40 kg, wysokość 131 mm



Depth/Głębokość	Finishing/Wykończenie	Packaging/Opakowanie	Cod.
350	Anthracite grey/Szary antracyt	1 KIT/Zestaw	3185335
450	Anthracite grey/Szary antracyt	1 KIT/Zestaw	3185435
500	Anthracite grey/Szary antracyt	1 KIT/Zestaw	3185535

Steel/Stal

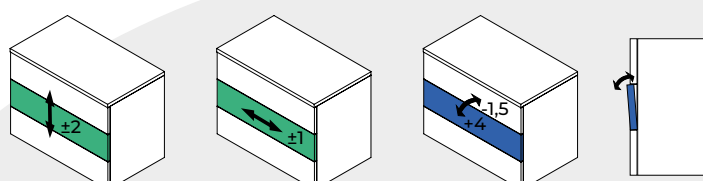
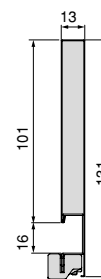
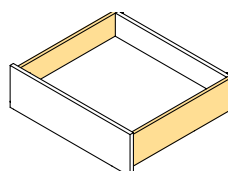

3D Vertex 40 kg exterior drawer height 178 mm
 Szuflada zewnętrzna Vertex 3D 40 kg, wysokość 178 mm



Depth/Głębokość	Finishing/Wykończenie	Packaging/Opakowanie	Cod.
350	Anthracite grey/Szary antracyt	1 KIT/Zestaw	3185635
450	Anthracite grey/Szary antracyt	1 KIT/Zestaw	3185735
500	Anthracite grey/Szary antracyt	1 KIT/Zestaw	3185835

Steel/Stal

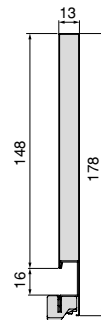
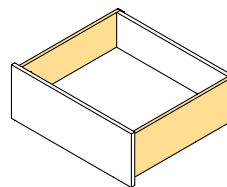

3D Vertex 40 kg exterior drawer height 242 mm
 Szuflada zewnętrzna Vertex 3D 40 kg, wysokość 242 mm



Depth/Głębokość	Finishing/Wykończenie	Packaging/Opakowanie	Cod.
450	Anthracite grey/Szary antracyt	1 KIT/Zestaw	3179335
500	Anthracite grey/Szary antracyt	1 KIT/Zestaw	3179435

Steel/Stal

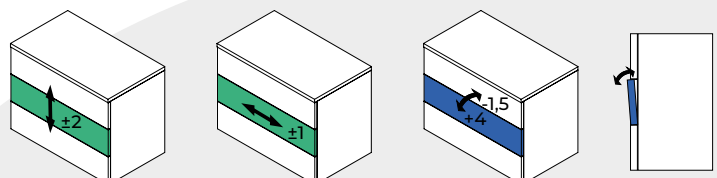
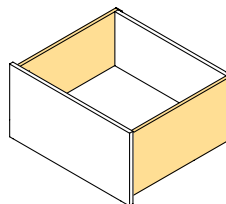

Vertex Drawer / Szuflada Vertex

VERTEX DRAWER KIT / ZESTAW SZUFLADA VERTEX

Vertex 40 kg exterior drawer height 83 mm

Szuflada zewnętrzna Vertex 40 kg, wysokość 83 mm



Depth/Głębokość	Finishing/Wykończenie	Packaging/Opakowanie	Cod.
450	Anthracite grey/Szary antracyt	1 KIT/Zestaw	3169935
500	Anthracite grey/Szary antracyt	1 KIT/Zestaw	3170035

Steel/Stal

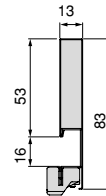
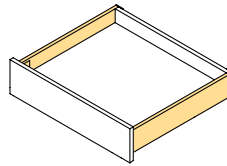
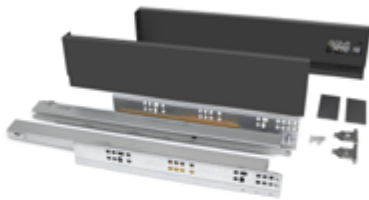

Vertex 40 kg exterior drawer height 93 mm

Szuflada zewnętrzna Vertex 40 kg, wysokość 93 mm



Depth/Głębokość	Finishing/Wykończenie	Packaging/Opakowanie	Cod.
300	Anthracite grey/Szary antracyt	1 KIT/Zestaw	3170235
350	Anthracite grey/Szary antracyt	1 KIT/Zestaw	3170335
400	Anthracite grey/Szary antracyt	1 KIT/Zestaw	3170435
450	Anthracite grey/Szary antracyt	1 KIT/Zestaw	3170535
500	Anthracite grey/Szary antracyt	1 KIT/Zestaw	3170635
550	Anthracite grey/Szary antracyt	1 KIT/Zestaw	3170735

Steel/Stal

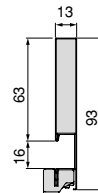
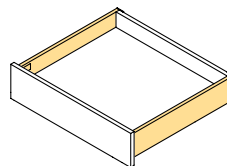
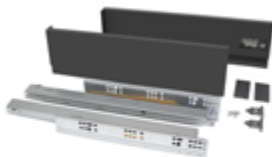

Vertex 40 kg exterior drawer height 131 mm
 Szuflada zewnętrzna Vertex 40 kg, wysokość 131 mm



Depth/Głębokość	Finishing/Wykończenie	Packaging/Opakowanie	Cod.
300	Anthracite grey/Szary antracyt	1 KIT/Zestaw	3170935
350	Anthracite grey/Szary antracyt	1 KIT/Zestaw	3171035
400	Anthracite grey/Szary antracyt	1 KIT/Zestaw	3171135
450	Anthracite grey/Szary antracyt	1 KIT/Zestaw	3171235
500	Anthracite grey/Szary antracyt	1 KIT/Zestaw	3171335

Steel/Stal

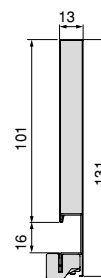
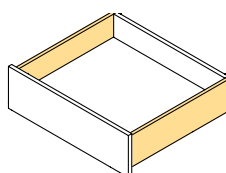
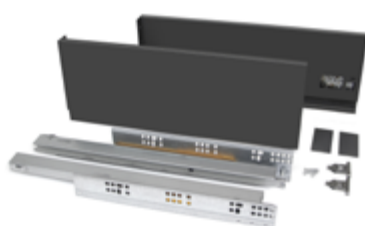

Vertex 40 kg exterior drawer height 178 mm
 Szuflada zewnętrzna Vertex 40 kg, wysokość 178 mm



Depth/Głębokość	Finishing/Wykończenie	Packaging/Opakowanie	Cod.
350	Anthracite grey/Szary antracyt	1 KIT/Zestaw	3171635
400	Anthracite grey/Szary antracyt	1 KIT/Zestaw	3171735
450	Anthracite grey/Szary antracyt	1 KIT/Zestaw	3171835
500	Anthracite grey/Szary antracyt	1 KIT/Zestaw	3171935

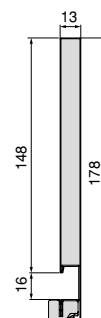
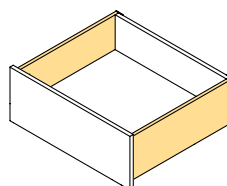

Steel/Stal



Vertex drawer kit for kitchen or bathroom, 93 mm height with included boards.

Zestaw szuflady do kuchni lub łazienki Vertex, o wysokości 93 mm, dostarczana wraz z płytami.



Width/Szerokość	Depth/Głębokość	Finishing/Wykończenie	Packaging/Opakowanie	Cod.
450	500	Anthracite grey/Szary antracyt 	1 KIT/Zestaw	3173035
600	500	Anthracite grey/Szary antracyt 	1 KIT/Zestaw	3173135
900	500	Anthracite grey/Szary antracyt 	1 KIT/Zestaw	3173235

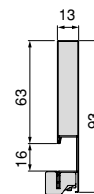
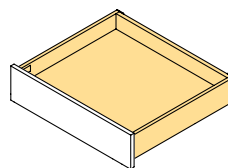
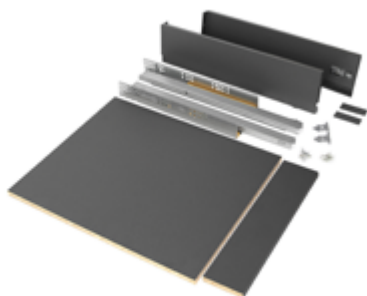

Various/Różne



Vertex drawer kit for kitchen or bathroom, 178 mm height with included boards.

Zestaw szuflady do kuchni lub łazienki Vertex, o wysokości 178 mm, dostarczana wraz z płytami.



Width/Szerokość	Depth/Głębokość	Finishing/Wykończenie	Packaging/Opakowanie	Cod.
450	500	Anthracite grey/Szary antracyt 	1 KIT/Zestaw	3173335
600	500	Anthracite grey/Szary antracyt 	1 KIT/Zestaw	3173435
900	500	Anthracite grey/Szary antracyt 	1 KIT/Zestaw	3173535

Various/Różne

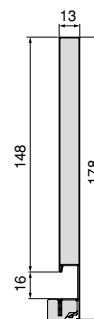
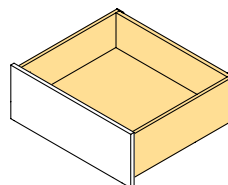
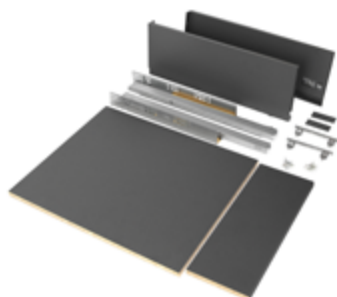

Vertex glass
Szkło Vertex



Vertex outer drawer 40 kg height 93 mm with glass sides

Szuflada zewnętrzna Vertex 40 kg wysokość 93 mm z przeszklonymi bokami



Depth/Głębokość	Finishing/Wykończenie	Packaging/Opakowanie	Cod.
450	Anthracite grey/Szary antracyt 	1 KIT/Zestaw	3130035
500	Anthracite grey/Szary antracyt 	1 KIT/Zestaw	3130135

Aluminium, Glass, Steel/Aluminium, Stal, Szkło

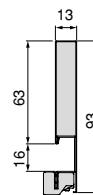
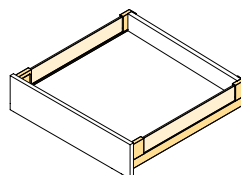

Vertex outer drawer 40 kg height 131 mm with glass sides

Szuflada zewnętrzna Vertex 40 kg wysokość 131 mm z przeszklonymi bokami



Depth/Głębokość	Finishing/Wykończenie	Packaging/Opakowanie	Cod.
450	Anthracite grey/Szary antracyt 	1 KIT/Zestaw	3130235
500	Anthracite grey/Szary antracyt 	1 KIT/Zestaw	3130335

Aluminium, Glass, Steel/Aluminium, Stal, Szkło

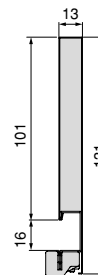
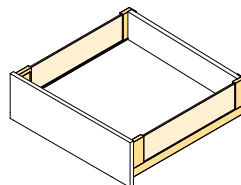
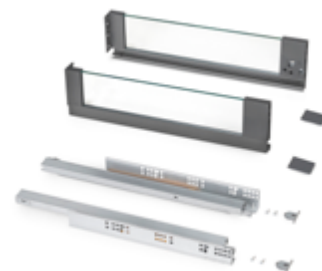

Vertex outer drawer 40 kg height 178 mm with glass sides

Szuflada zewnętrzna Vertex 40 kg wysokość 178 mm z przeszklonymi bokami



Depth/Głębokość	Finishing/Wykończenie	Packaging/Opakowanie	Cod.
450	Anthracite grey/Szary antracyt 	1 KIT/Zestaw	3130435
500	Anthracite grey/Szary antracyt 	1 KIT/Zestaw	3130535

Aluminium, Glass, Steel/Aluminium, Stal, Szkło

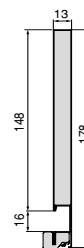
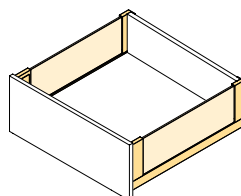
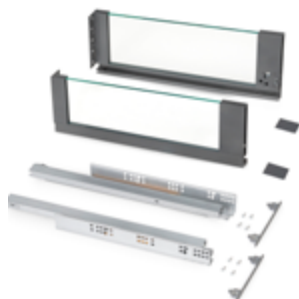

Cajón exterior Vertex 60 kg de altura 93 mm

Gaveta exterior Vertex 60 kg altura 93 mm



Profundidad/Profundidade	Acabado/Acabamento	Embalaje/Embalagem	Cod.
500	Cris antracita/Gris antracite	1 KIT/KIT	3179035

Acero/Aço

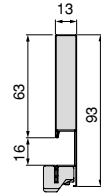
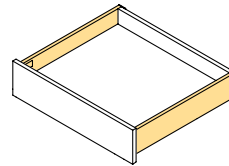

Vertex 60 kg exterior drawer height 131 mm

Szuflada zewnętrzna Vertex 60 kg, wysokość 131 mm



Depth/Głębokość	Finishing/Wykończenie	Packaging/Opakowanie	Cod.
500	Anthracite grey/Szary antracyt	1 KIT/Zestaw	3179135

Steel/Stal

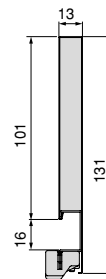
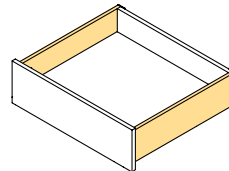
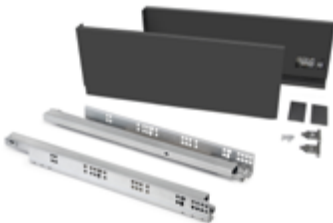

Vertex 60 kg exterior drawer height 178 mm

Szuflada zewnętrzna Vertex 60 kg, wysokość 178 mm



Depth/Głębokość	Finishing/Wykończenie	Packaging/Opakowanie	Cod.
500	Anthracite grey/Szary antracyt	1 KIT/Zestaw	3179235

Steel/Stal

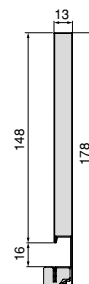
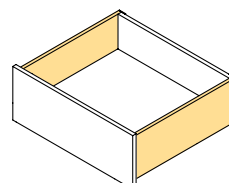

Vertex 40 kg exterior drawer height 93 mm for 18 mm board

Szuflada zewnętrzna Vertex 40 kg, wysokość 93 mm na płytę 18 mm



Depth/Głębokość	Finishing/Wykończenie	Packaging/Opakowanie	Cod.
450	Anthracite grey/Szary antracyt 	1 KIT/Zestaw	3202535

Steel/Stal

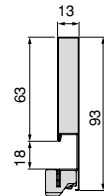
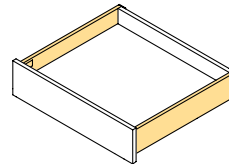
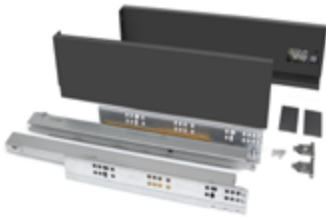

Vertex 40 kg exterior drawer height 131 mm for 18 mm board

Szuflada zewnętrzna Vertex 40 kg, wysokość 131 mm na płytę 18 mm



Height/Wysokość	Depth/Głębokość	Finishing/Wykończenie	Packaging/Opakowanie	Cod.
131	450	Anthracite grey/Szary antracyt 	1 KIT/Zestaw	3202635

Steel/Stal

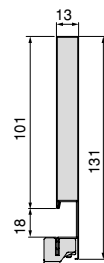
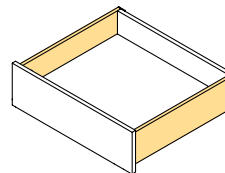
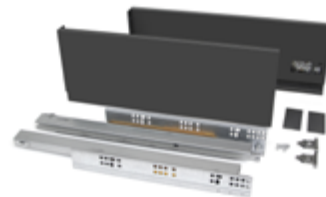

Vertex 40 kg exterior drawer height 178 mm for 18 mm board

Szuflada zewnętrzna Vertex 40 kg, wysokość 178 mm na płytę 18 mm



Depth/Głębokość	Finishing/Wykończenie	Packaging/Opakowanie	Cod.
450	Anthracite grey/Szary antracyt 	1 KIT/Zestaw	3202735

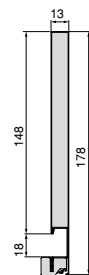
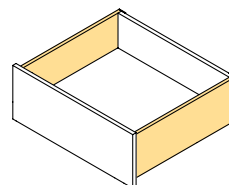

Steel/Stal



Vertex outer drawer 40 kg height 93 mm with Push Synchro

Szuflada zewnętrzna Vertex 40 kg wysokość 93 mm z systemem Push Synchro



Depth/Głębokość	Finishing/Wykończenie	Packaging/Opakowanie	Cod.
350	Anthracite grey/Szary antracyt 	1 KIT/Zestaw	3201035
400	Anthracite grey/Szary antracyt 	1 KIT/Zestaw	3201135
450	Anthracite grey/Szary antracyt 	1 KIT/Zestaw	3201235
500	Anthracite grey/Szary antracyt 	1 KIT/Zestaw	3201335



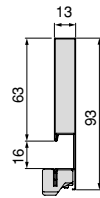
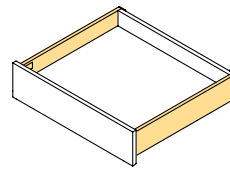

Steel/Stal



Vertex outer drawer 40 kg height 131 mm with Push Synchro

Szuflada zewnętrzna Vertex 40 kg wysokość 131 mm z systemem Push Synchro



Depth/Głębokość	Finishing/Wykończenie	Packaging/Opakowanie	Cod.
350	Anthracite grey/Szary antracyt 	1 KIT/Zestaw	3201435
400	Anthracite grey/Szary antracyt 	1 KIT/Zestaw	3201535
450	Anthracite grey/Szary antracyt 	1 KIT/Zestaw	3201635
450	Anthracite grey/Szary antracyt 	1 KIT/Zestaw	3197635
500	Anthracite grey/Szary antracyt 	1 KIT/Zestaw	3201735

Steel/Stal

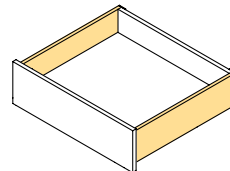

Vertex outer drawer 40 kg height 178 mm with Push Synchro

Szuflada zewnętrzna Vertex 40 kg wysokość 178 mm z systemem Push Synchro



Depth/Głębokość	Finishing/Wykończenie	Packaging/Opakowanie	Cod.
350	Anthracite grey/Szary antracyt	1 KIT/Zestaw	3201835
400	Anthracite grey/Szary antracyt	1 KIT/Zestaw	3201935
450	Anthracite grey/Szary antracyt	1 KIT/Zestaw	3202035
500	Anthracite grey/Szary antracyt	1 KIT/Zestaw	3202135

Steel/Stal

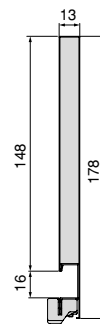
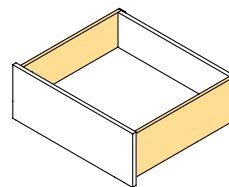

Synchronizing set for Vertex slides with Push Synchro 2

Zestaw synchronizatorów do prowadnic Vertex z Push Synchro 2



Finishing/Wykończenie	Packaging/Opakowanie	Cod.
Natural aluminium/Naturalne aluminium	10 Unit/Szt	3202261

Aluminium/Aluminium



It is recommended for the assembly of drawers wider than 600 mm.

Zalecany do montażu szuflad szerszych niż 600 mm.

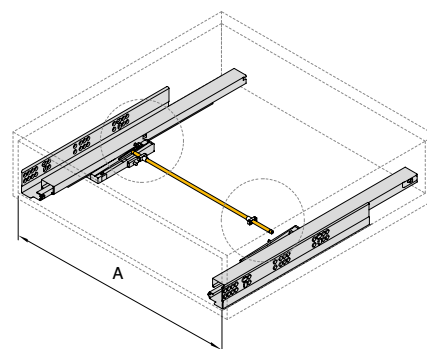
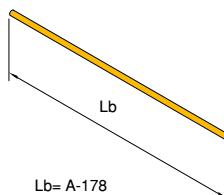
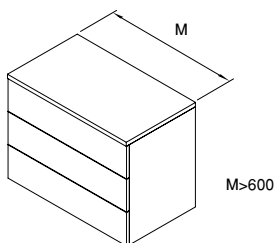

Vertex metal sides height 93 mm LEFT

Bok do szuflady Vertex o wysokości 93 mm LEWY



Depth/Głębokość	Finishing/Wykończenie	Packaging/Opakowanie	Cod.
300	Anthracite grey/Szary antracyt	20 Unit/Szt	3181235
350	Anthracite grey/Szary antracyt	20 Unit/Szt	3180235
400	Anthracite grey/Szary antracyt	20 Unit/Szt	3184235
450	Anthracite grey/Szary antracyt	20 Unit/Szt	3180635
500	Anthracite grey/Szary antracyt	20 Unit/Szt	3180835

Steel/Stal

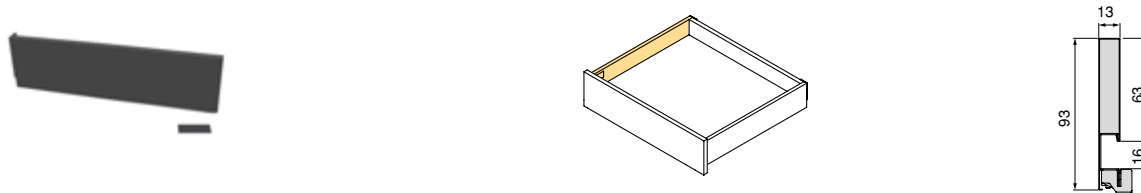

Vertex metal sides height 93 mm RIGHT

Bok do szuflady Vertex o wysokości 93 mm PRAWY



Depth/Głębokość	Finishing/Wykończenie	Packaging/Opakowanie	Cod.
300	Anthracite grey/Szary antracyt	20 Unit/Szt	3181335
350	Anthracite grey/Szary antracyt	20 Unit/Szt	3180335
400	Anthracite grey/Szary antracyt	20 Unit/Szt	3184335
450	Anthracite grey/Szary antracyt	20 Unit/Szt	3180735
500	Anthracite grey/Szary antracyt	20 Unit/Szt	3180935

Steel/Stal

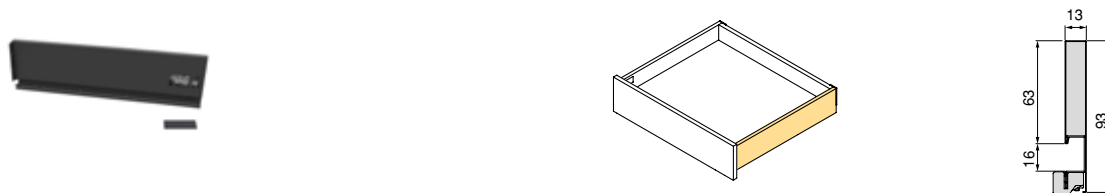

Vertex metal sides height 131 mm LEFT

Bok do szuflady Vertex o wysokości 131 mm LEWY



Depth/Głębokość	Finishing/Wykończenie	Packaging/Opakowanie	Cod.
300	Anthracite grey/Szary antracyt	20 Unit/Szt	3181035
350	Anthracite grey/Szary antracyt	20 Unit/Szt	3181635
400	Anthracite grey/Szary antracyt	20 Unit/Szt	3184435
450	Anthracite grey/Szary antracyt	20 Unit/Szt	3182035
500	Anthracite grey/Szary antracyt	20 Unit/Szt	3182235

Steel/Stal

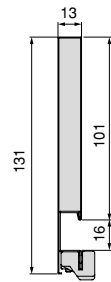
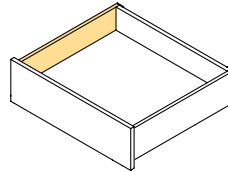

Vertex metal sides height 131 mm RIGHT

Bok do szuflady Vertex o wysokości 131 mm PRAWY



Depth/Głębokość	Finishing/Wykończenie	Packaging/Opakowanie	Cod.
300	Anthracite grey/Szary antracyt	20 Unit/Szt	3181135
350	Anthracite grey/Szary antracyt	20 Unit/Szt	3181735
400	Anthracite grey/Szary antracyt	20 Unit/Szt	3184535
450	Anthracite grey/Szary antracyt	20 Unit/Szt	3182135
500	Anthracite grey/Szary antracyt	20 Unit/Szt	3182335

Steel/Stal

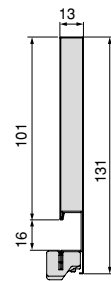
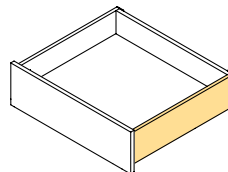

Vertex metal sides height 178 mm LEFT

Bok do szuflady Vertex o wysokości 178 mm LEWY



Depth/Głębokość	Finishing/Wykończenie	Packaging/Opakowanie	Cod.
350	Anthracite grey/Szary antracyt	10 Unit/Szt	3183035
400	Anthracite grey/Szary antracyt	10 Unit/Szt	3184635
450	Anthracite grey/Szary antracyt	10 Unit/Szt	3183435
500	Anthracite grey/Szary antracyt	10 Unit/Szt	3183635

Steel/Stal

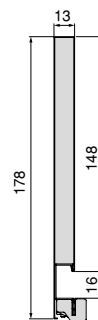
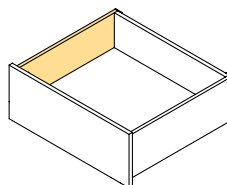

Vertex metal sides height 178 mm RIGHT

Bok do szuflady Vertex o wysokości 178 mm PRAWY



Depth/Głębokość	Finishing/Wykończenie	Packaging/Opakowanie	Cod.
350	Anthracite grey/Szary antracyt	10 Unit/Szt	3183135
400	Anthracite grey/Szary antracyt	10 Unit/Szt	3184735
450	Anthracite grey/Szary antracyt	10 Unit/Szt	3183535
500	Anthracite grey/Szary antracyt	10 Unit/Szt	3183735

Steel/Stal

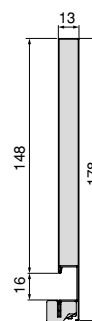
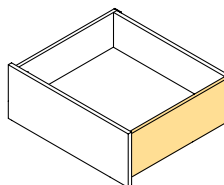

Vertex 40 kg runner slides with soft closing LEFT

Prowadnica szuflady Vertex 40 kg z cichym domykaniem LEWY



Depth/Głębokość	Finishing/Wykończenie	Packaging/Opakowanie	Cod.
300	Zinc plated/Cynkowane	20 Unit/Szt	3181405
350	Zinc plated/Cynkowane	20 Unit/Szt	3177405
400	Zinc plated/Cynkowane	20 Unit/Szt	3177605
450	Zinc plated/Cynkowane	20 Unit/Szt	3177805
500	Zinc plated/Cynkowane	20 Unit/Szt	3178005

Steel/Stal

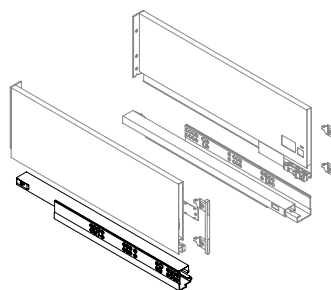

Vertex 40 kg runner slides with soft closing RIGHT

Prowadnica szuflady Vertex 40 kg z cichym domykaniem PRAWY



Depth/Głębokość	Finishing/Wykończenie	Packaging/Opakowanie	Cod.
300	Zinc plated/Cynkowane	20 Unit/Szt	3181505
350	Zinc plated/Cynkowane	20 Unit/Szt	3177505
400	Zinc plated/Cynkowane	20 Unit/Szt	3177705
450	Zinc plated/Cynkowane	20 Unit/Szt	3177905
500	Zinc plated/Cynkowane	20 Unit/Szt	3178105

Steel/Stal

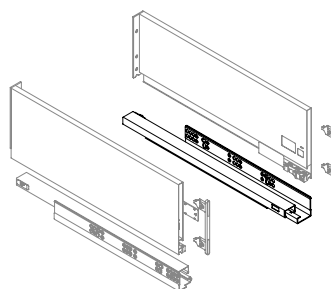

Kit of front clip for drawer

Zestaw zacisków do szuflad



Description/Opis	Finishing/Wykończenie	Packaging/Opakowanie	Cod.
Screw-on/Przykręcane	Zinc plated/Cynkowane	100 Pair/Kpl.	3104005
Knock-in Ø10 x 11/Wciskane Ø10 x 11	Zinc plated/Cynkowane	100 Pair/Kpl.	3104105

Steel/Stal

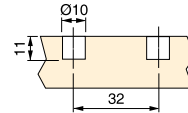

Press fit Ø10 x 11/Mocowanie na wcisk Ø10 x 11

Kit of front clip height 178 mm

Zestaw haczyków do szuflady Vertex o wysokości 178 mm



Description/Opis	Finishing/Wykończenie	Packaging/Opakowanie	Cod.
Screw-on/Przykręcane	Zinc plated/Cynkowane	50 Pair/Kpl.	3176005
Knock-in Ø10 x 11/Wciskane Ø10 x 11	Zinc plated/Cynkowane	50 Pair/Kpl.	3176105

Steel/Stal

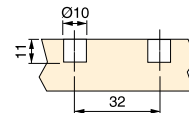

Press fit Ø10 x 11/Mocowanie na wcisk Ø10 x 11

Placa embellecedora para cajones
Placa embelezadora para gavetas

Acabado/Acabamento	Embalaje/Embalagem	Cod.
Gris antracita/Cris antracite 	500 UN/UN	3193023

Plástico/Plástico

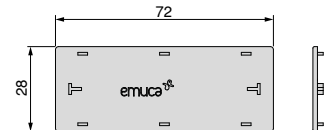

50x15 piastra esterna per cassetto
50x15 Außenverkleidungsplatte für Schublade

Acabado/Acabamento	Embalaje/Embalagem	Cod.
Plástico gris antracita/Plástico gris antracite 	20 UN/UN	3273023

Plástico/Plástico

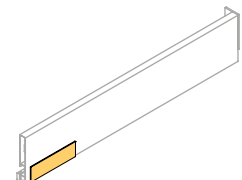
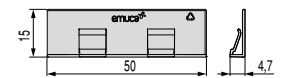

Interior Vertex Wnętrze Vertex

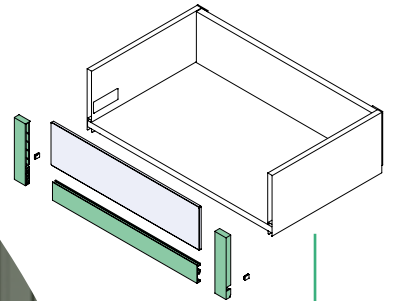
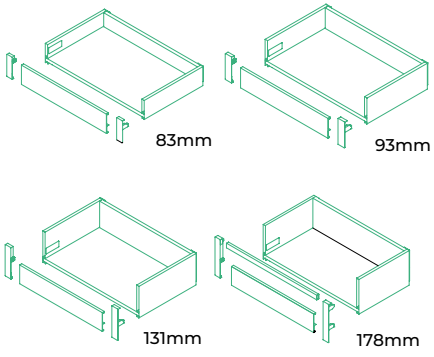

Set of frontal fittings for 83 mm inner drawer
 Zestaw zaczepów frontowych do szuflady wewnętrznej Vertex o wysokości 83 mm



Height/Wysokość	Finishing/Wykończenie	Packaging/Opakowanie	Cod.
83	Anthracyte grey plastic/Szaro-antracytowy plastik 	4 Pair/Kpl.	3172023

Plastic/Plastik

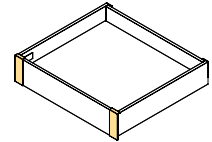

Set of frontal fittings for 93 mm inner drawer
 Zestaw zaczepów frontowych do szuflady wewnętrznej Vertex o wysokości 93 mm



Height/Wysokość	Finishing/Wykończenie	Packaging/Opakowanie	Cod.
93	Anthracyte grey plastic/Szaro-antracytowy plastik 	4 Pair/Kpl.	3172123

Plastic/Plastik

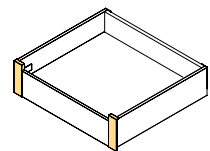

Set of frontal fittings for 131 mm inner drawer
 Zestaw zaczepów frontowych do szuflady wewnętrznej Vertex o wysokości 131 mm



Height/Wysokość	Finishing/Wykończenie	Packaging/Opakowanie	Cod.
131	Anthracyte grey plastic/Szaro-antracytowy plastik 	4 Pair/Kpl.	3172223

Plastic/Plastik

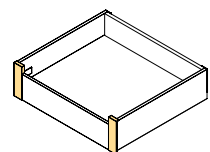

Set of frontal fittings for 178 mm inner drawer

Zestaw zaczepów frontowych do szuflady wewnętrznej Vertex o wysokości 178 mm



Height/Wysokość	Finishing/Wykończenie	Packaging/Opakowanie	Cod.
178	Anthracite grey plastic/Szaro-antracytowy plastik 	4 Pair/Kpl.	3172323

Plastic/Plastik

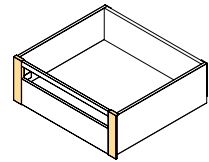

Frontal profile for inner drawer

Profil frontowy do szuflady wewnętrznej Vertex



Longitude/Długość	Finishing/Wykończenie	Packaging/Opakowanie	Cod.
1,10 m	Anthracite grey/Szary antracyt 	10 Unit/Szt	3172435

Aluminium/Aluminium

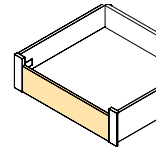
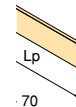
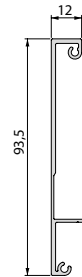

Frontal railing for inner drawer

Reling frontowy



Height/Wysokość	Longitude/Długość	Finishing/Wykończenie	Packaging/Opakowanie	Cod.
178	1,12 m	Anthracite grey/Szary antracyt 	10 Unit/Szt	3113435

Aluminium/Aluminium

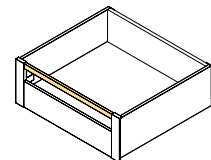
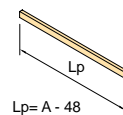
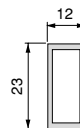

Set of front connectors for Vertex internal glass drawer 93 mm high

Zestaw łączników frontu do wewnętrznej szklanej szuflady Vertex o wysokości 93 mm



Finishing/Wykończenie	Packaging/Opakowanie	Cod.
Anthracite grey plastic/Szaro-antracytowy plastik 	4 Pair/Kpl.	3186023

Plastic/Plastik

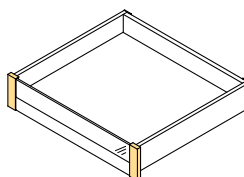

Set of front connectors for Vertex internal glass drawer 131 mm high

Zestaw łączników frontu do wewnętrznej szklanej szuflady Vertex o wysokości 131 mm



Finishing/Wykończenie	Packaging/Opakowanie	Cod.
Anthracite grey plastic/Szaro-antracytowy plastik 	4 Pair/Kpl.	3186123

Plastic/Plastik

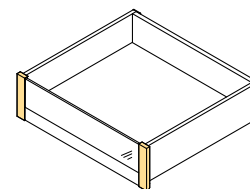

Set of front connectors for Vertex internal glass drawer 178 mm high

Zestaw łączników frontu do wewnętrznej szklanej szuflady Vertex o wysokości 178 mm



Finishing/Wykończenie	Packaging/Opakowanie	Cod.
Anthracite grey plastic/Szaro-antracytowy plastik 	4 Pair/Kpl.	3186223

Plastic/Plastik

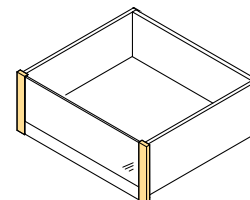

Front profile for Vertex glass internal drawers
 Profil frontu do szklanych szuflad wewnętrznych Vertex



Longitude/Długość	Finishing/Wykończenie	Packaging/Opakowanie	Cod.
1,11 m	Anthracite grey/Szary antracyt	10 Unit/Szt	3186335

Aluminium/Aluminium

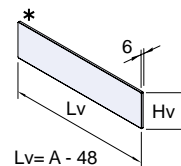
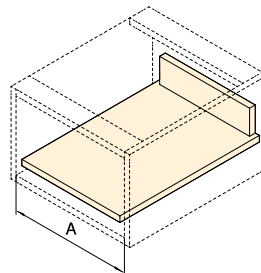
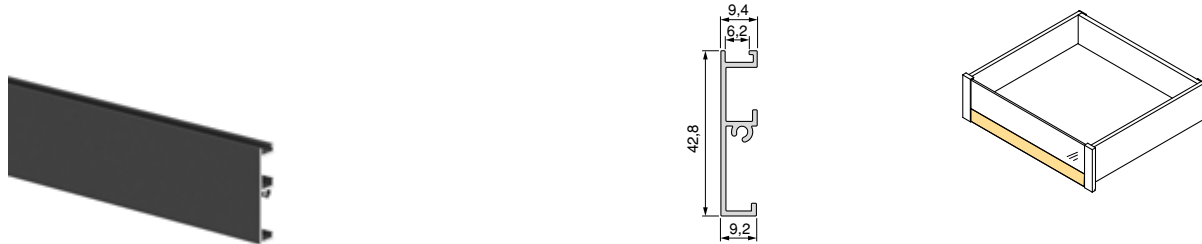

Lv = A - 48

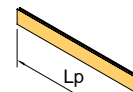

Lp = A - 58

H	Hv
93	63
131	101
178	148

Combinations Kombinacje

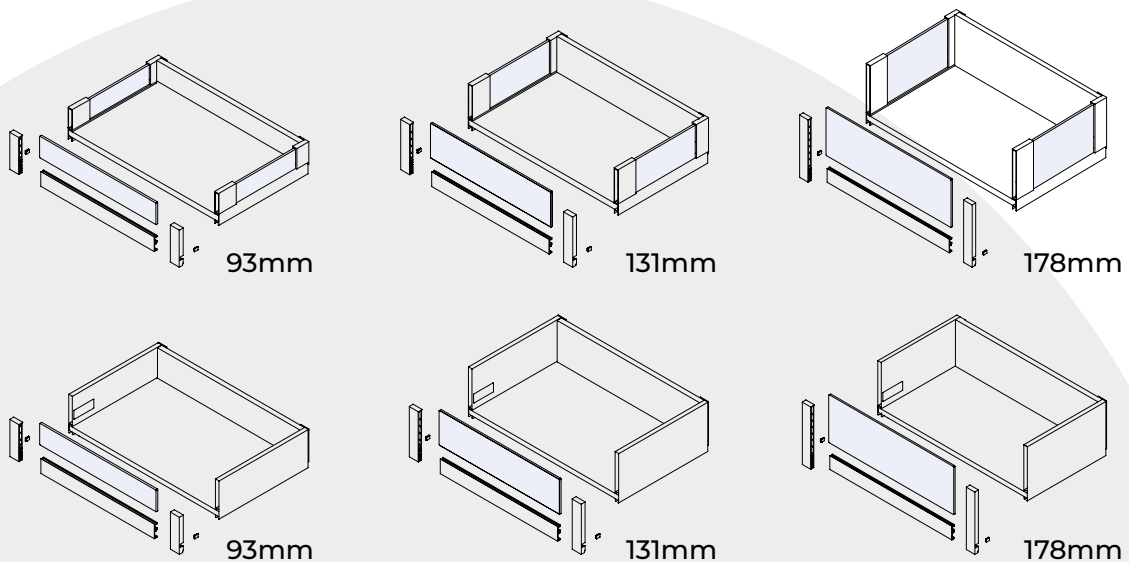

*Glass front not included.
 *Szkłany front nie wchodzi w skład zestawu.



**Concept Drawer
Szuflada Concept**

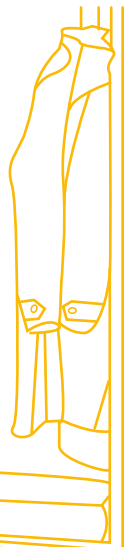

Cajón exterior Concept 30 kg de altura 105 mm
 Gaveta exterior Concept 30 kg altura 105 mm



Profundidad/Profundidade	Acabado/Acabamento		Embalaje/Embalagem	Cod.
270	Gris antracita/Gris antracite		1 KIT/KIT	3100355
300	Gris antracita/Gris antracite		1 KIT/KIT	3100135
350	Gris antracita/Gris antracite		1 KIT/KIT	3100235
400	Gris antracita/Gris antracite		1 KIT/KIT	3100335
450	Gris antracita/Gris antracite		1 KIT/KIT	3100435
500	Gris antracita/Gris antracite		1 KIT/KIT	3100535

Acero/Aço

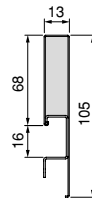
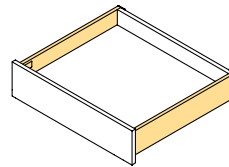

Concept 30 kg exterior drawer height 138 mm
 Szuflada zewnętrzna Concept 30 kg wysokość 138 mm



Depth/Głębokość	Finishing/Wykończenie		Packaging/Opakowanie	Cod.
270	Anthracite grey/Szary antracyt		1 KIT/Zestaw	3100635
300	Anthracite grey/Szary antracyt		1 KIT/Zestaw	3100735
350	Anthracite grey/Szary antracyt		1 KIT/Zestaw	3100835
400	Anthracite grey/Szary antracyt		1 KIT/Zestaw	3100935
450	Anthracite grey/Szary antracyt		1 KIT/Zestaw	3101035
500	Anthracite grey/Szary antracyt		1 KIT/Zestaw	3101135

Steel/Stal

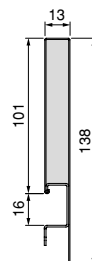
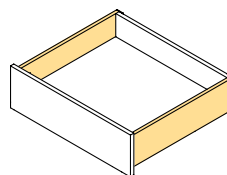

Concept 30 kg exterior drawer height 185 mm
 Szuflada zewnętrzna Concept 30 kg wysokość 185 mm



Depth/Głębokość	Finishing/Wykończenie	Packaging/Opakowanie	Cod.
350	Anthracite grey/Szary antracyt	1 KIT/Zestaw	3101435
400	Anthracite grey/Szary antracyt	1 KIT/Zestaw	3101535
450	Anthracite grey/Szary antracyt	1 KIT/Zestaw	3101635
500	Anthracite grey/Szary antracyt	1 KIT/Zestaw	3101735

Steel/Stal

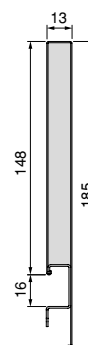
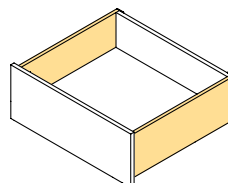



Concept metal sides height 105 mm LEFT

Bok do szuflady Concept o wysokości 105 mm LEWY



Depth/Głębokość	Finishing/Wykończenie	Packaging/Opakowanie	Cod.
350	Anthracite grey/Szary antracyt 	20 Unit/Szt	3106735

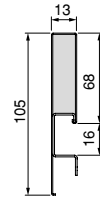
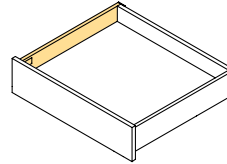

Steel/Stal

Concept metal sides height 105 mm RIGHT

Bok do szuflady Concept o wysokości 105 mm PRAWY



Depth/Głębokość	Finishing/Wykończenie	Packaging/Opakowanie	Cod.
350	Anthracite grey/Szary antracyt 	20 Unit/Szt	3106035

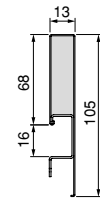
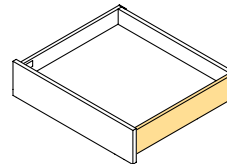

Steel/Stal

Concept metal sides height 138 mm LEFT

Bok do szuflady Concept o wysokości 138 mm LEWY



Depth/Głębokość	Finishing/Wykończenie	Packaging/Opakowanie	Cod.
350	Anthracite grey/Szary antracyt 	20 Unit/Szt	3108135

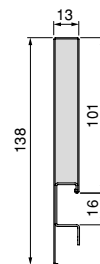
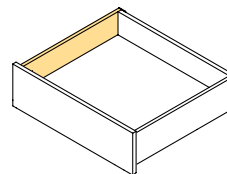

Steel/Stal

Concept metal sides height 138 mm RIGHT

Bok do szuflady Concept o wysokości 138 mm PRAWY



Depth/Głębokość	Finishing/Wykończenie	Packaging/Opakowanie	Cod.
350	Anthracite grey/Szary antracyt 	20 Unit/Szt	3107435

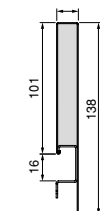
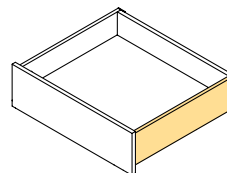

Steel/Stal

Concept 30 kg runner slides with soft closing LEFT
Prowadnica Concept 30 kg z cichym domykaniem LEWY



Depth/Głębokość	Finishing/Wykończenie	Packaging/Opakowanie	Cod.
350	Zinc plated/Cynkowane	20 Unit/Szt	3105305

Steel/Stal



Concept 30 kg runner slides with soft closing RIGHT
Prowadnice Concept 30 kg z delikatnym domykaniem PRAWY



Depth/Głębokość	Finishing/Wykończenie	Packaging/Opakowanie	Cod.
350	Zinc plated/Cynkowane	20 Unit/Szt	3104605

Steel/Stal



Kit of front clip for drawer
Zestaw zacisków do szuflad



Description/Opis	Finishing/Wykończenie	Packaging/Opakowanie	Cod.
Screw-on/Przykręcane	Zinc plated/Cynkowane	100 Pair/Kpl.	3104005
Knock-in Ø10 x 11/Wciskane Ø10 x 11	Zinc plated/Cynkowane	100 Pair/Kpl.	3104105

Steel/Stal

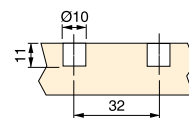

Press fit Ø10 x 11/Mocowanie na wcisk Ø10 x 11

Drawer trim plate
Pokrywa szuflady

Finishing/Wykończenie	Packaging/Opakowanie	Cod.
Anthracite grey/Szary antracyt	500 Unit/Szt	3193023

Plástico/Plástico

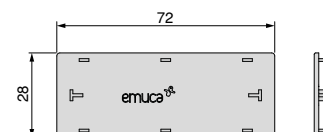

Set of frontal fittings for 105 mm inner drawer
 Zestaw frontowych elementów mocujących 105 mm



Height/Wysokość	Finishing/Wykończenie	Packaging/Opakowanie	Cod.
105	Anthracyte grey plastic/Szaro-antracytowy plastik 	4 Pair/Kpl.	3113023

Plastic/Plastik

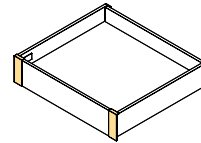

Set of frontal fittings for 138 mm inner drawer
 Zestaw frontowych elementów mocujących 138 mm



Height/Wysokość	Finishing/Wykończenie	Packaging/Opakowanie	Cod.
138	Anthracyte grey plastic/Szaro-antracytowy plastik 	4 Pair/Kpl.	3113123

Plastic/Plastik

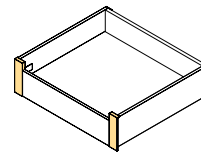

Set of frontal fittings for 185 mm inner drawer
 Zestaw frontowych elementów mocujących 185 mm



Height/Wysokość	Finishing/Wykończenie	Packaging/Opakowanie	Cod.
185	Anthracyte grey plastic/Szaro-antracytowy plastik 	4 Pair/Kpl.	3113223

Plastic/Plastik

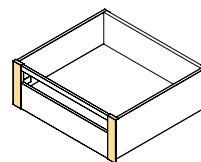

Frontal profile for inner drawer
 Profil frontowy

Longitude/Długość	Finishing/Wykończenie	Packaging/Opakowanie	Cod.
1,07 m	Anthracite grey/Szary antracyt	10 Unit/Szt	3113335

Aluminium/Aluminium

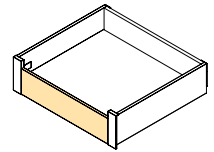
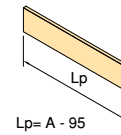
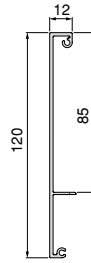

Frontal railing for inner drawer
 Reeling frontowy



Height/Wysokość	Longitude/Długość	Finishing/Wykończenie	Packaging/Opakowanie	Cod.
178	1,12 m	Anthracite grey/Szary antracyt	10 Unit/Szt	3113435

Aluminium/Aluminium

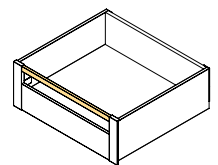
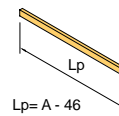
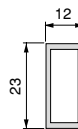

Convex Drawer Wypukła Szuflada

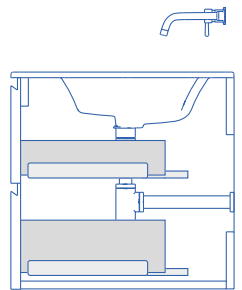
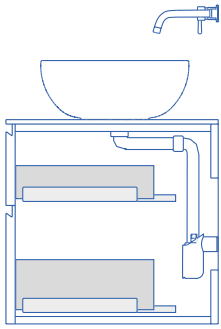

Convex metal sides height 90 mm RIGHT

Bok do szuflady Convex o wysokości 90 mm PRAWY



Depth/Głębokość	Finishing/Wykończenie	Packaging/Opakowanie	Cod.
300	Anthracite grey/Szary antracyt	20 Unit/Szt	3117135
350	Anthracite grey/Szary antracyt	20 Unit/Szt	3119235
400	Anthracite grey/Szary antracyt	20 Unit/Szt	3117335
450	Anthracite grey/Szary antracyt	20 Unit/Szt	3117535

Plastic, Steel/Plastik, Stal

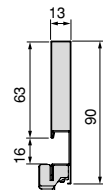
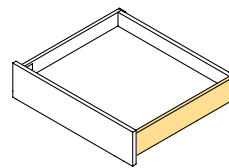

Convex metal sides height 90 mm LEFT

Bok do szuflady Convex o wysokości 90 mm LEWY



Depth/Głębokość	Finishing/Wykończenie	Packaging/Opakowanie	Cod.
300	Anthracite grey/Szary antracyt	20 Unit/Szt	3117235
350	Anthracite grey/Szary antracyt	20 Unit/Szt	3119335
400	Anthracite grey/Szary antracyt	20 Unit/Szt	3117435
450	Anthracite grey/Szary antracyt	20 Unit/Szt	3117635

Plastic, Steel/Plastik, Stal

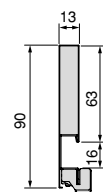
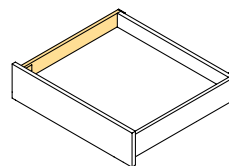
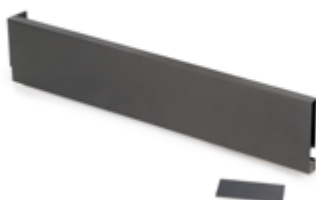

Convex metal sides height 128 mm RIGHT

Bok do szuflady Convex o wysokości 128 mm PRAWY



Depth/Głębokość	Finishing/Wykończenie	Packaging/Opakowanie	Cod.
300	Anthracite grey/Szary antracyt	20 Unit/Szt	3117735
350	Anthracite grey/Szary antracyt	20 Unit/Szt	3119435
400	Anthracite grey/Szary antracyt	20 Unit/Szt	3117935
450	Anthracite grey/Szary antracyt	20 Unit/Szt	3118135

Plastic, Steel/Plastik, Stal

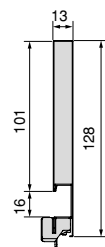
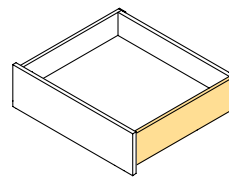

Convex metal sides height 128 mm LEFT

Bok do szuflady Convex o wysokości 128 mm LEWY



Depth/Głębokość	Finishing/Wykończenie	Packaging/Opakowanie	Cod.
300	Anthracite grey/Szary antracyt	20 Unit/Szt	3117835
350	Anthracite grey/Szary antracyt	20 Unit/Szt	3119535
400	Anthracite grey/Szary antracyt	20 Unit/Szt	3118035
450	Anthracite grey/Szary antracyt	20 Unit/Szt	3118235

Plastic, Steel/Plastik, Stal

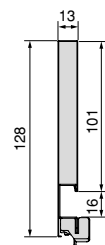
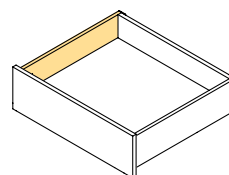
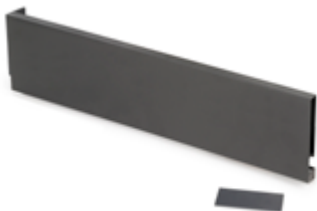

Convex 25 kg runner slides with soft closing RIGHT

Prowadnica szuflady Convex 25 kg z cichym domykaniem PRAWY



Depth/Głębokość	Finishing/Wykończenie	Packaging/Opakowanie	Cod.
350	Zinc plated/Cynkowane	20 Unit/Szt	3116505
450	Zinc plated/Cynkowane	20 Unit/Szt	3116705
400	Zinc plated/Cynkowane	20 Unit/Szt	3119005
500	Zinc plated/Cynkowane	20 Unit/Szt	3116905

Steel/Stal

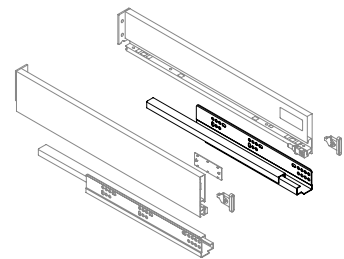
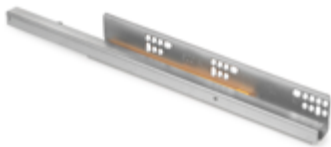

Convex 25 kg runner slides with soft closing LEFT

Prowadnica szuflady Convex 25 kg z cichym domykaniem LEWY



Depth/Głębokość	Finishing/Wykończenie	Packaging/Opakowanie	Cod.
350	Zinc plated/Cynkowane	20 Unit/Szt	3116605
450	Zinc plated/Cynkowane	20 Unit/Szt	3116805
400	Zinc plated/Cynkowane	20 Unit/Szt	3119105
500	Zinc plated/Cynkowane	20 Unit/Szt	3117005

Steel/Stal

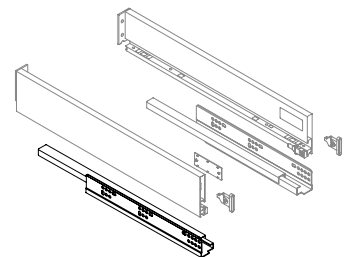

Kit of front clip for drawer
Zestaw zacisków do szuflad



Description/Opis	Finishing/Wykończenie	Packaging/Opakowanie	Cod.
Screw-on/Przykręcane	Zinc plated/Cynkowane	100 Pair/Kpl.	3104005
Knock-in Ø10 x 11/Wciskane Ø10 x 11	Zinc plated/Cynkowane	100 Pair/Kpl.	3104105

Steel/Stal

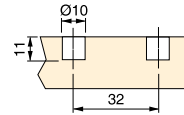

Press fit Ø10 x 11/Mocowanie na wcisk Ø10 x 11

Drawer cover plate
Płyta maskująca do szuflad

Finishing/Wykończenie	Packaging/Opakowanie	Cod.
Anthracite grey/Szary antracyt	500 Unit/Szt	3193023

Plastic/Plastik

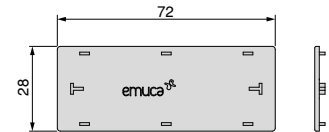

External cover plate 50x15 for drawer
Zewnętrzna pokrywa 50x15 do szuflady

Finishing/Wykończenie	Packaging/Opakowanie	Cod.
Anthracite grey plastic/Szaro-antracytowy plastik	20 Unit/Szt	3273023

Plastic/Plastik

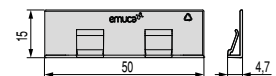
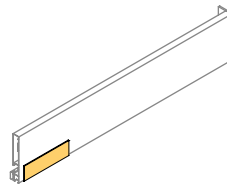

Customizable trim plate for any type of drawer. Vertex/Concept/Convex

Możliwość dostosowania pokrywy do dowolnego typu szuflady. Vertex/Concept/Convex





Simplex Drawer
Szuflada Simplex



Set of sides for Simplex drawer height 88 mm
 Zestaw bok do szuflady Simplex o wysokości 88 mm



Depth/Głębokość	Finishing/Wykończenie	Packaging/Opakowanie	Cod.
300	Anthracite grey/Szary antracyt	10 Pair/Kpl.	3275035
400	Anthracite grey/Szary antracyt	10 Pair/Kpl.	3275135
350	Anthracite grey/Szary antracyt	10 Pair/Kpl.	3275235
450	Anthracite grey/Szary antracyt	10 Pair/Kpl.	3275335
300	Anthracite grey/Szary antracyt	10 Pair/Kpl.	3275435

Steel/Stal

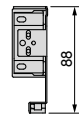

Set of sides for Simplex drawer height 159 mm
 Zestaw bok do szuflady Simplex o wysokości 159 mm



Depth/Głębokość	Finishing/Wykończenie	Packaging/Opakowanie	Cod.
300	Anthracite grey/Szary antracyt	10 Pair/Kpl.	3276035
350	Anthracite grey/Szary antracyt	10 Pair/Kpl.	3276135
400	Anthracite grey/Szary antracyt	10 Pair/Kpl.	3276235
450	Anthracite grey/Szary antracyt	10 Pair/Kpl.	3276335
500	Anthracite grey/Szary antracyt	10 Pair/Kpl.	3276435

Steel/Stal

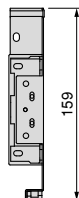
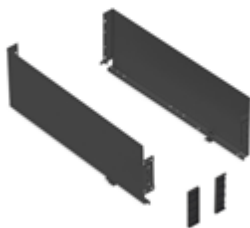

Set of gallery rails for Simplex drawers
Zestaw relingów do szuflad Simplex

Depth/Głębokość	Finishing/Wykończenie	Packaging/Opakowanie	Cod.
290	Anthracite grey/Szary antracyt	10 Pair/Kpl.	3277035
340	Anthracite grey/Szary antracyt	10 Pair/Kpl.	3277135
390	Anthracite grey/Szary antracyt	10 Pair/Kpl.	3277235
440	Anthracite grey/Szary antracyt	10 Pair/Kpl.	3277335
490	Anthracite grey/Szary antracyt	10 Pair/Kpl.	3277435

Steel/Stal



Silver concealed drawer runners with total extracion and soft closing (240 - 590)
Ukrytych prowadnic kulkowych Silver do szuflad, całkowity wysuw, cichy domyk (240 - 590)



Depth/Głębokość	Finishing/Wykończenie	Packaging/Opakowanie	Cod.
290	Zinc plated/Cynkowane	10 Pair/Kpl.	3124105
340	Zinc plated/Cynkowane	10 Pair/Kpl.	3124205
390	Zinc plated/Cynkowane	10 Pair/Kpl.	3124305
440	Zinc plated/Cynkowane	10 Pair/Kpl.	3124405
490	Zinc plated/Cynkowane	10 Pair/Kpl.	3124505

Steel/Stal



Guías ocultas Silver para cajones de extracción parcial con cierre suave
Corrediças ocultas Silver para gavetas de extração parcial com fecho suave



Mano/Mão	Profundidad/Profundidade	Acabado/Acabamento	Embalaje/Embalagem	Cod.
Izquierda/Derecha/Esquerda/Direita	290	Cincado/Zincado	10 JG/JG	3019105
Izquierda/Derecha/Esquerda/Direita	340	Cincado/Zincado	10 JG/JG	3019205
Izquierda/Derecha/Esquerda/Direita	390	Cincado/Zincado	10 JG/JG	3019305
Izquierda/Derecha/Esquerda/Direita	440	Cincado/Zincado	10 JG/JG	3019405
Izquierda/Derecha/Esquerda/Direita	490	Cincado/Zincado	10 JG/JG	3019505

Acero/Aço



Silver concealed drawer runners with partial extraction and push system
Ukrytych prowadnic kulkowych Silver do szuflad, częściowy wysuw, push



Depth/Głębokość	Finishing/Wykończenie	Packaging/Opakowanie	Cod.
290	Zinc plated/Cynkowane	10 Pair/Kpl.	3123105
340	Zinc plated/Cynkowane	10 Pair/Kpl.	3123205
390	Zinc plated/Cynkowane	10 Pair/Kpl.	3123305
440	Zinc plated/Cynkowane	10 Pair/Kpl.	3123405
490	Zinc plated/Cynkowane	10 Pair/Kpl.	3123505



Steel/Stal

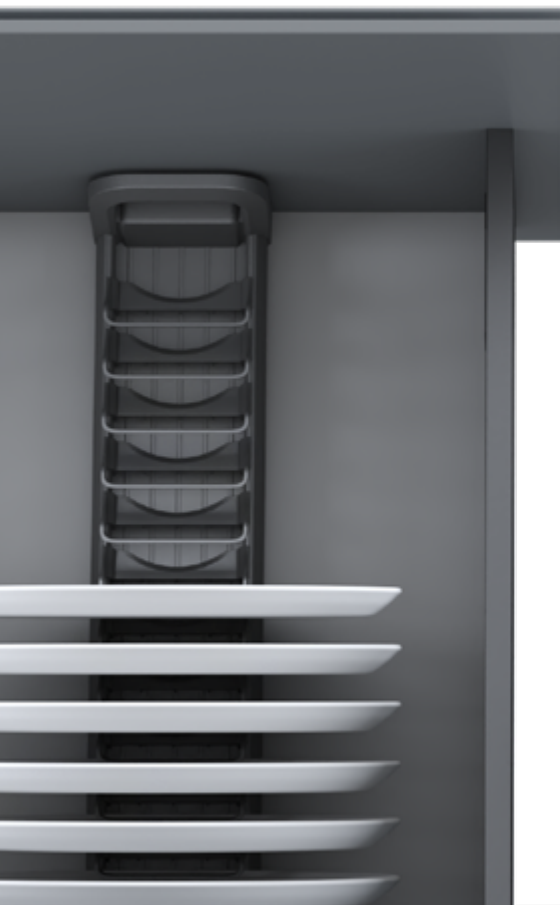
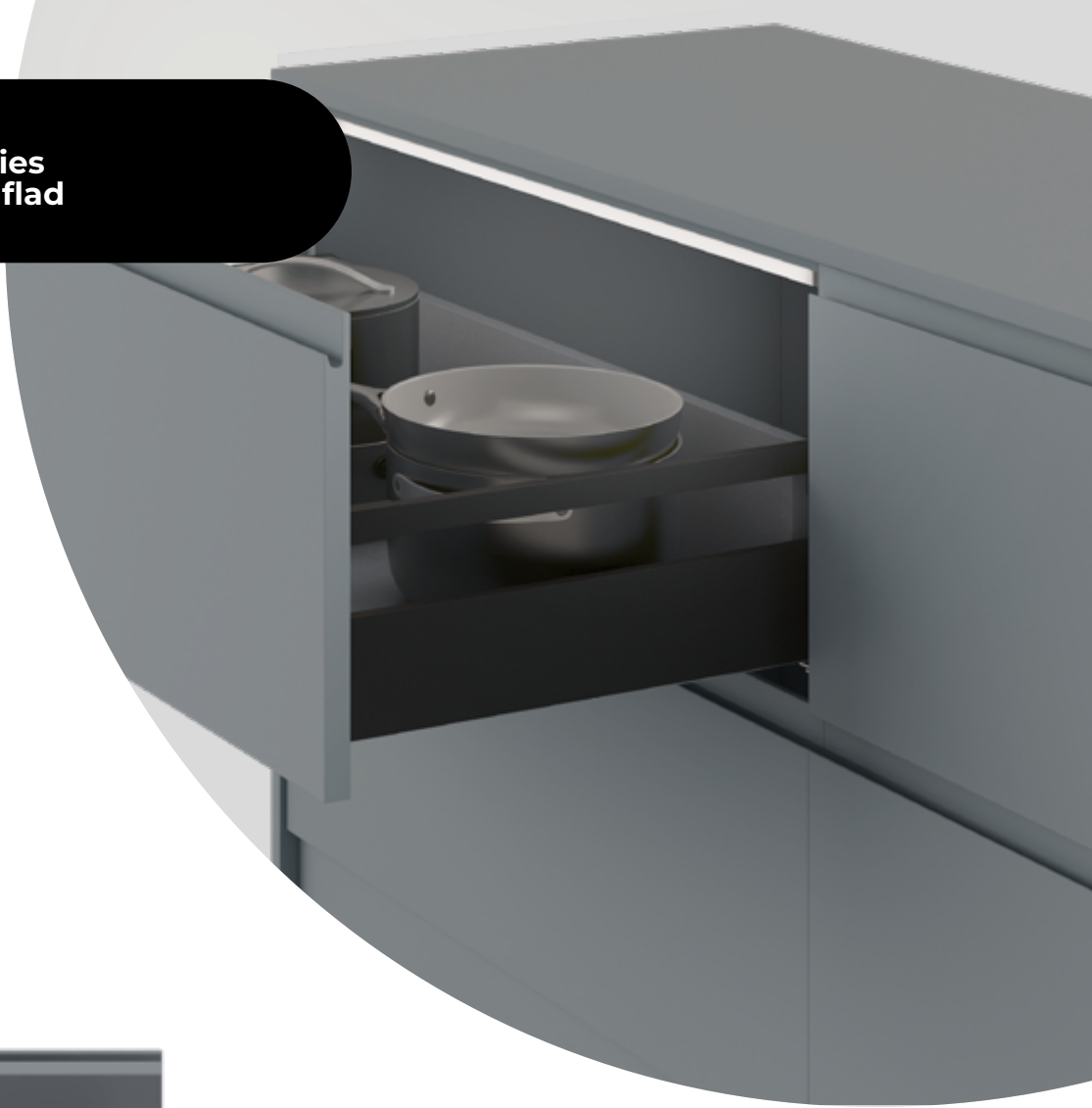

**Drawer Accessories
Akcesoria do Szuflad**



Set of gallery rails for kitchen and bathroom drawers
Zestaw relingów do szuflad kuchennych i łazienkowych

Depth/Głębokość	Finishing/Wykończenie	Packaging/Opakowanie	Cod.
300	Anthracite grey/Szary antracyt 	20 Pair/Kpl.	3110135
350	Anthracite grey/Szary antracyt 	20 Pair/Kpl.	3110235
400	Anthracite grey/Szary antracyt 	20 Pair/Kpl.	3110335
450	Anthracite grey/Szary antracyt 	20 Pair/Kpl.	3110435
500	Anthracite grey/Szary antracyt 	20 Pair/Kpl.	3110535

Steel/Stal



Set of rear hooks for drawer railing
Zestaw tylnych haczyków do szyn szuflad

Acabado/Acabamento	Embalaje/Embalagem	Cod.
Gris antracita/Cris antracite 	20 JG/JG	3142035

Plástico/Plástico

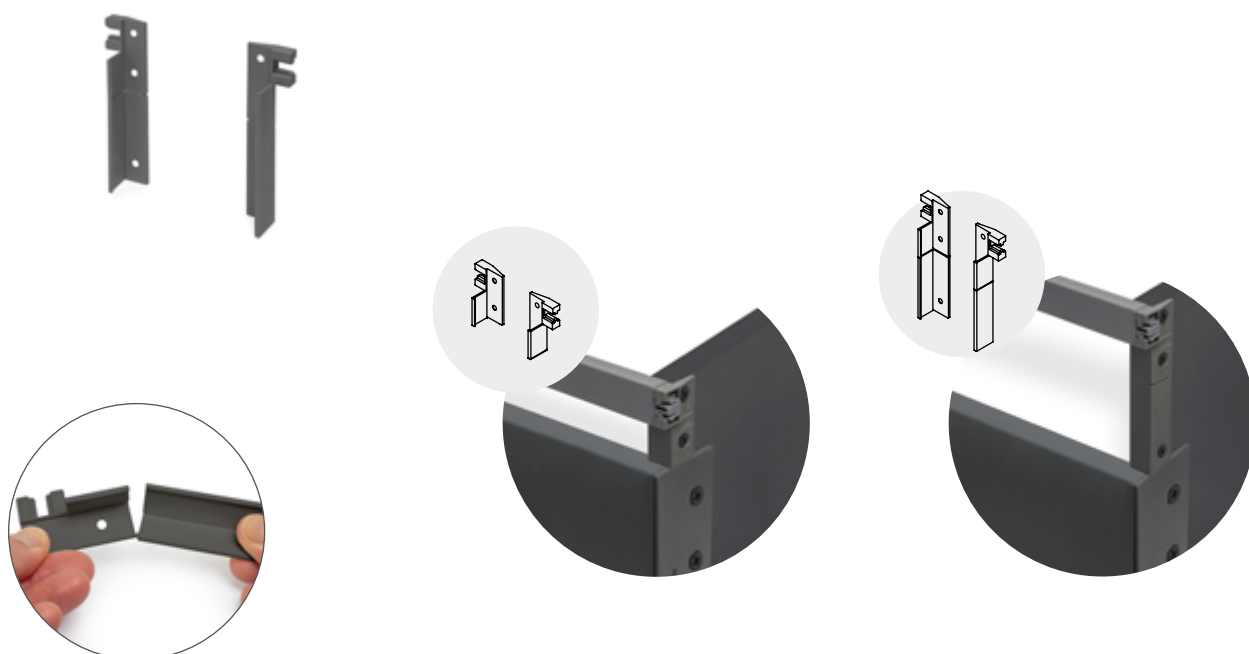

Screw-on front fixing for railing for Concept drawer
 Przykręcany frontowy element mocujący do relingu do szuflad Concept

Finishing/Wykończenie	Packaging/Opakowanie	Cod.
Grey plastic/Szary plastik	200 Unit/Szt	3110021

Plastic/Plastik

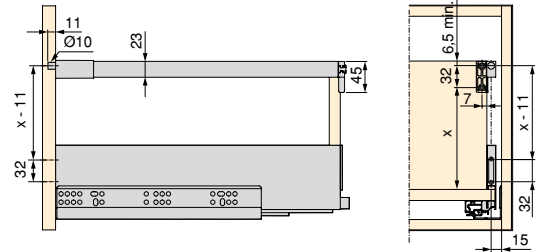

Set of dividers for interior of Vertex-Concept drawers
 Adjustable drawer organiser kit

Width/Szerokość	Finishing/Wykończenie	Packaging/Opakowanie	Cod.
600	Anthracite grey/Szary antracyt	1 Unit/Szt	3184035
900	Anthracite grey/Szary antracyt	1 Unit/Szt	3184135

Aluminium, Plastic/Aluminium, Plastik

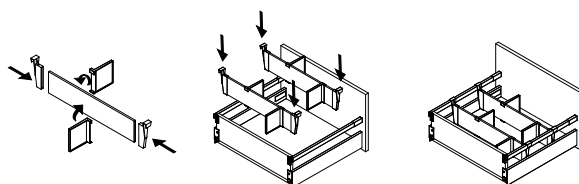
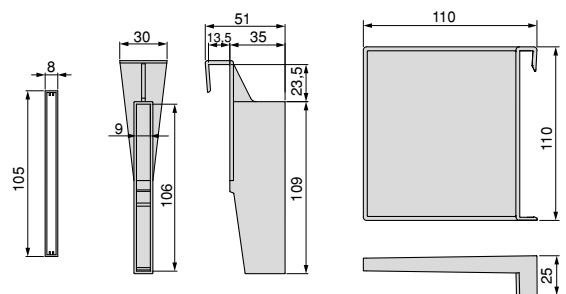

Lokbox joint for fastening the drawer bottom to the front
 Łącznik frontu Lokbox do mocowania dna szuflady do krawędzi



Finishing/Wykończenie	Packaging/Opakowanie	Cod.
Grey plastic/Szary plastik 	100 Unit/Szt	3002621

Plastic/Plastik

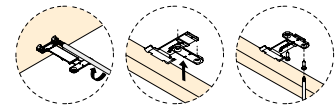
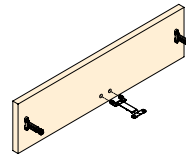
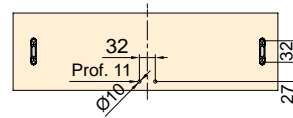

Lateral spacer for drawer
 Przekładka boczna do szuflad



Finishing/Wykończenie	Packaging/Opakowanie	Cod.
Anthracite grey plastic/Szaro-antracytowy plastik 	4 Unit/Szt	3110823

Plastic/Plastik

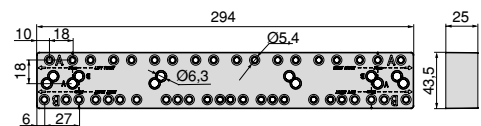
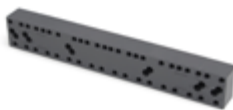

Template to marked the clip of the drawer front
 Szablon do mocowania zacisku frontu szuflady

Finishing/Wykończenie	Packaging/Opakowanie	Cod.
Grey plastic/Szary plastik 	1 Pair/Kpl.	3114021

Plastic/Plastik

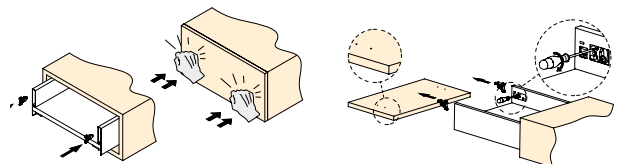

Orderbox organizer 100x470 for drawer
Orderbox organizer 100x470 do szuflady

Height/Wysokość	Longitude/Długość	Depth/Głębokość	Finishing/Wykończenie	Packaging/Opakowanie	Cod.
55	100	470	Anthracite grey/Szary antracyt 	1 Unit/Szt	3069035

Steel, Wood/Drewno, Stal

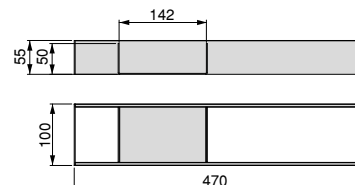

Orderbox organizer 150x470 for drawer
Orderbox 150x470 organizer do szuflady

Height/Wysokość	Longitude/Długość	Depth/Głębokość	Finishing/Wykończenie	Packaging/Opakowanie	Cod.
55	150	470	Anthracite grey/Szary antracyt 	1 Unit/Szt	3069135

Steel, Wood/Drewno, Stal

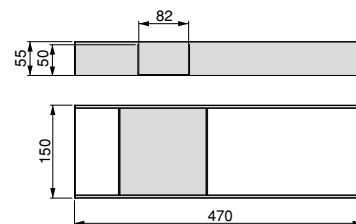

Orderbox inclined organizer 150x470 for drawer
Orderbox 150x470 organizer skośny do szuflady

Height/Wysokość	Longitude/Długość	Depth/Głębokość	Finishing/Wykończenie	Packaging/Opakowanie	Cod.
55	150	470	Anthracite grey/Szary antracyt 	1 Unit/Szt	3069235

Steel, Wood/Drewno, Stal

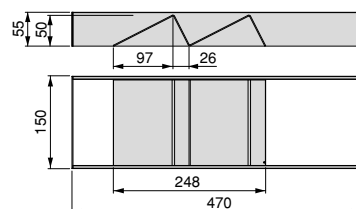

Orderbox knife holder 150x470 for drawer
Uchwyt na noże Orderbox 150x470 do szuflady

Height/Wysokość	Longitude/Długość	Depth/Głębokość	Finishing/Wykończenie	Packaging/Opakowanie	Cod.
55	150	470	Anthracite grey/Szary antracyt 	1 Unit/Szt	3069335

Steel, Wood/Drewno, Stal

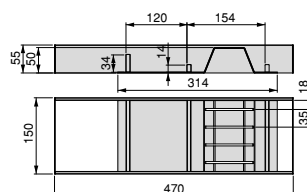

Orderbox plate holder 120x470 for drawer
 Uchwyt na płytę Orderbox 120x470 do szuflady

Longitude/Długość	Depth/Głębokość	Finishing/Wykończenie	Packaging/Opakowanie	Cod.
120	470	Anthracite grey/Szary antracyt	1 Unit/Szt	3069435

Aluminium, Plastic/Aluminium, Plastik

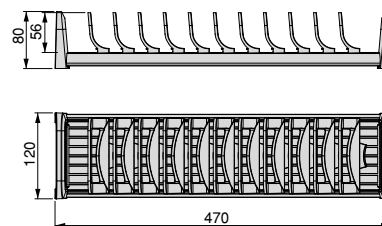

Orderbox bowl holder 90x470 for drawer
 Orderbox 90x470 uchwyt na talerze do szuflady

Longitude/Długość	Depth/Głębokość	Finishing/Wykończenie	Packaging/Opakowanie	Cod.
90	470	Anthracite grey/Szary antracyt	1 Unit/Szt	3069535

Aluminium, Plastic/Aluminium, Plastik

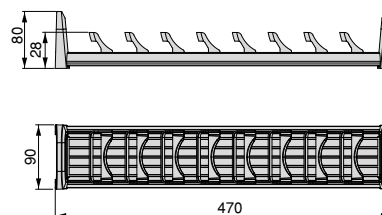

Orderbox vertical plate holder for drawer
 Orderbox pionowy uchwyt na talerze do szuflady

Height/Wysokość	Longitude/Długość	Depth/Głębokość	Finishing/Wykończenie	Packaging/Opakowanie	Cod.
180	160	470	Anthracite grey/Szary antracyt	1 Unit/Szt	3069635

Aluminium, Plastic/Aluminium, Plastik

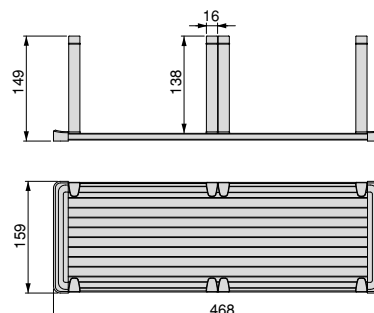

Slim rectangular under-sink insert for drawer
 Prostokątna szuflada oszczędzająca syfon

Finishing/Wykończenie	Packaging/Opakowanie	Cod.
Anthracite grey plastic/Szaro-antracytowy plastik	14 Unit/Szt	3011923
Anthracite grey plastic/Szaro-antracytowy plastik	100 Unit/Szt	3016623

Plastic/Plastik

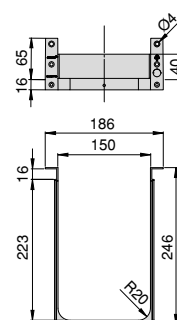
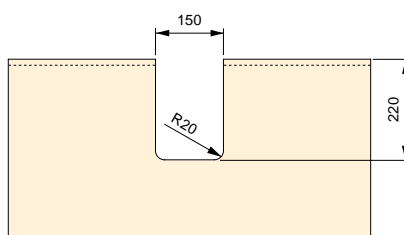

Slim rectangular H56 under-sink insert for drawer
 Prostokątna szuflada H56 oszczędzająca syfon

Finishing/Wykończenie	Packaging/Opakowanie	Cod.
Anthracite grey plastic/Szaro-antracytowy plastik	100 Unit/Szt	3016723

Plastic/Plastik

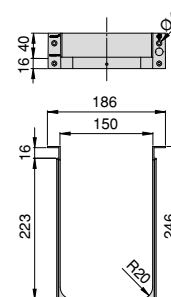
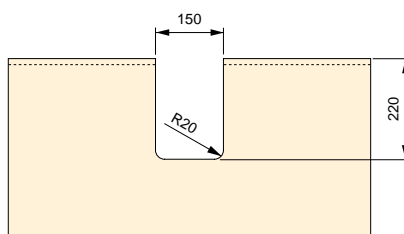

Rectangular under-sink insert for drawer
 Zapisz prostokątny syfon do szuflad

Finishing/Wykończenie	Packaging/Opakowanie	Cod.
Anthracite grey plastic/Szaro-antracytowy plastik 	10 Unit/Szt	3044223

Plastic/Plastik

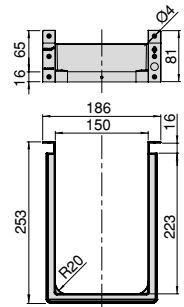
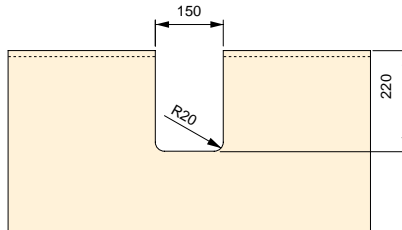

Rectangular under sink insert for bathroom drawer
 Uchwyt prostokątny do szuflady łazienkowej



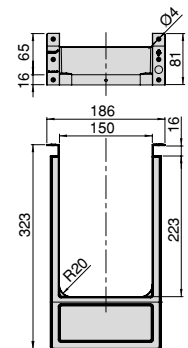
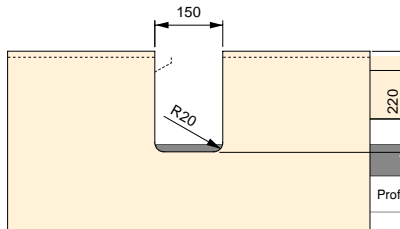

Finishing/Wykończenie	Packaging/Opakowanie	Cod.
Anthracite grey plastic/Szaro-antracytowy plastik 	6 Unit/Szt	3044123

Plastic/Plastik



Vantage-Q curved undersink insert
 Osłona syfonu, zaokrąglona



Finishing/Wykończenie	Packaging/Opakowanie	Cod.
Anthracite grey plastic/Szaro-antracytowy plastik 	100 Unit/Szt	3044423
Anthracite grey plastic/Szaro-antracytowy plastik 	10 Unit/Szt	3044323

Plastic/Plastik

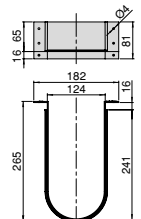
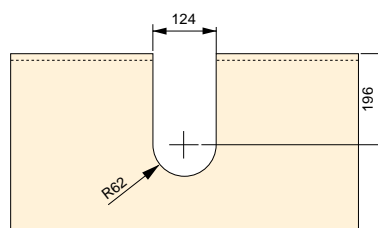
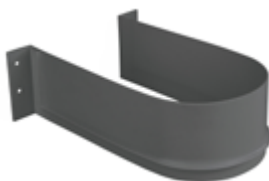

Rectangular siphon saver for bath drawer Tidy
 Prostokątna osłona syfonu do szuflady łazienkowej Tidy

Finishing/Wykończenie	Packaging/Opakowanie	Cod.
Anthracite grey plastic/Szaro-antracytowy plastik 	10 Unit/Szt	8098023

Plastic/Plastik

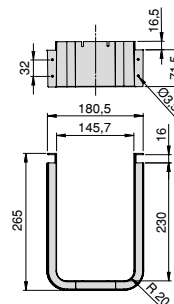
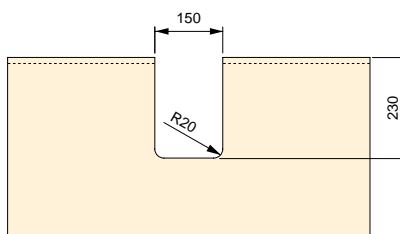

Steel under-sink insert
 Metalowy tył szuflady pod zlewozmywakiem ze stali



B	Finishing/Wykończenie	Packaging/Opakowanie	Cod.
200	Anthracite grey/Szary antracyt 	10 Unit/Szt	3021435
350	Anthracite grey/Szary antracyt 	10 Unit/Szt	3014535
550	Anthracite grey/Szary antracyt 	10 Unit/Szt	3017935

Steel/Stal

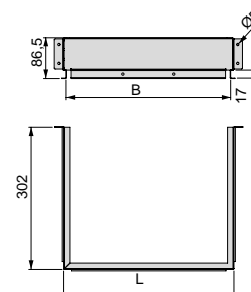
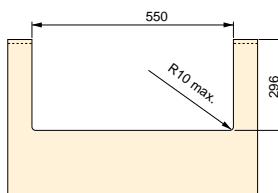
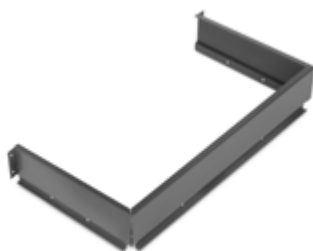

Runners
Prowadnice



Ball bearing drawer runner T30
 Prowadnic kulkowych do szuflad, częściowy wysuw T30



Longitude/Długość	Finishing/Wykończenie		Packaging/Opakowanie	Cod.
250	Black painted/Malowane na czarno	■	25 Pair/Kpl.	4388414
300	Black painted/Malowane na czarno	■	25 Pair/Kpl.	4388614
350	Black painted/Malowane na czarno	■	25 Pair/Kpl.	4388714
400	Black painted/Malowane na czarno	■	25 Pair/Kpl.	4388814
450	Black painted/Malowane na czarno	■	25 Pair/Kpl.	4388914
500	Black painted/Malowane na czarno	■	25 Pair/Kpl.	4389014
550	Black painted/Malowane na czarno	■	25 Pair/Kpl.	4389114
600	Black painted/Malowane na czarno	■	25 Pair/Kpl.	4389214

Steel/Stal

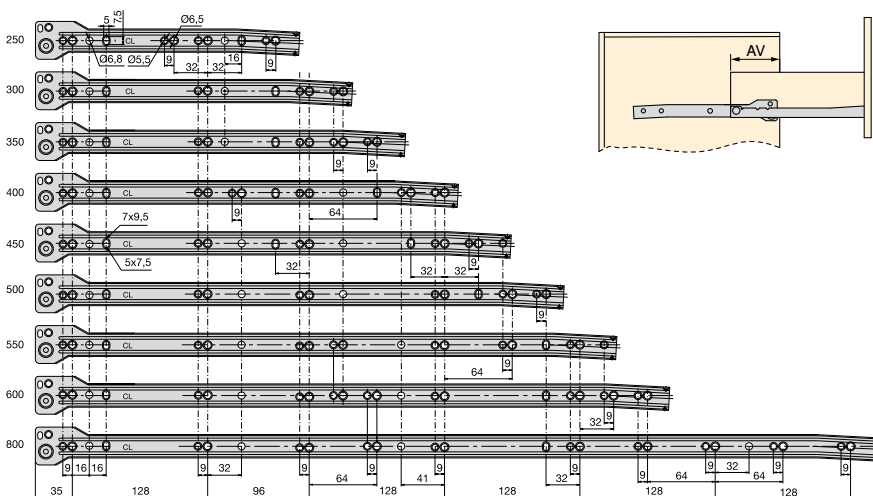
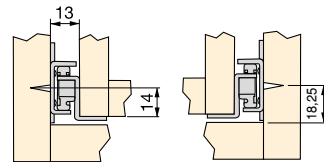

Prof.	AV
250	85
300	85
350	85
400	85
450	95
500	105
550	110
600	119
800	159

Slides T30M machine mounted to the drawer
 Prowadnice T30M do montaży maszynowego w szufladzie



Longitud/Comprimento	Descripción/Descrição	Mano/Mão	Acabado/Acabamento	Embalaje/Embalagem	Cod.
300	Z - Machine/Z - Maszyna	Z - LEFT/Z - LEWY	Black painted/Malowane na czarno	100 Unit/Szt	4389614
300	Z - Machine/Z - Maszyna	Z - RIGHT/Z - PRAWO	Black painted/Malowane na czarno	100 Unit/Szt	4389714
350	Z - Machine/Z - Maszyna	Z - LEFT/Z - LEWY	Black painted/Malowane na czarno	100 Unit/Szt	4390014
350	Z - Machine/Z - Maszyna	Z - RIGHT/Z - PRAWO	Black painted/Malowane na czarno	100 Unit/Szt	4390114
400	Z - Machine/Z - Maszyna	Z - LEFT/Z - LEWY	Black painted/Malowane na czarno	100 Unit/Szt	4390414
400	Z - Machine/Z - Maszyna	Z - RIGHT/Z - PRAWO	Black painted/Malowane na czarno	100 Unit/Szt	4390514
300	C - Screw/C- Śruba	C - LEFT/Z - LEWY	Black painted/Malowane na czarno	100 Unit/Szt	4389414
300	C - Screw/C- Śruba	C - RIGHT/Z - PRAWO	Black painted/Malowane na czarno	100 Unit/Szt	4389514
350	C - Screw/C- Śruba	C - LEFT/Z - LEWY	Black painted/Malowane na czarno	100 Unit/Szt	4389814
350	C - Screw/C- Śruba	C - RIGHT/Z - PRAWO	Black painted/Malowane na czarno	100 Unit/Szt	4389914
400	C - Screw/C- Śruba	C - LEFT/Z - LEWY	Black painted/Malowane na czarno	100 Unit/Szt	4390214
400	C - Screw/C- Śruba	C - RIGHT/Z - PRAWO	Black painted/Malowane na czarno	100 Unit/Szt	4390314
300	C - Sockets Ø8x8/C - Gniazda Ø8x8	C - LEFT/Z - LEWY	Black painted/Malowane na czarno	100 Unit/Szt	4394514
300	C - Sockets Ø8x8/C - Gniazda Ø8x8	C - RIGHT/Z - PRAWO	Black painted/Malowane na czarno	100 Unit/Szt	4394614
350	C - Sockets Ø8x8/C - Gniazda Ø8x8	C - LEFT/Z - LEWY	Black painted/Malowane na czarno	100 Unit/Szt	4394714
350	C - Sockets Ø8x8/C - Gniazda Ø8x8	C - RIGHT/Z - PRAWO	Black painted/Malowane na czarno	100 Unit/Szt	4394814

Acero/Aço



- C= Side guide.
- Z= Drawer slide.
- Runners with black painted finish (14) correspond to RAL 9005, white (12) RAL 9001 and aluminum (25) RAL 9022.

- C= Prowadnica boczna.
- Z= Prowadnica szuflady.
- Prowadnice z czarnym wykończeniem (14) odpowiadają RAL 9005, białe (12) RAL 9001 i aluminiowe (25) RAL 9022.

Prof.	AV
300	85
350	85
400	85
450	95
500	105
600	119

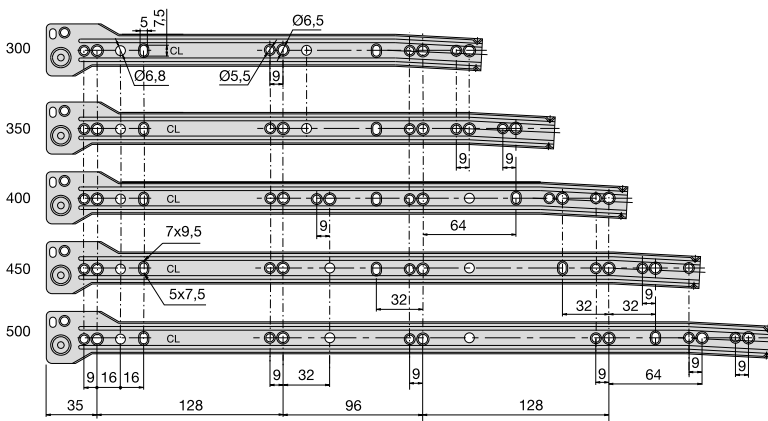
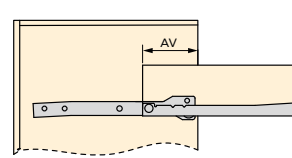

C - Screw/C - Śruba

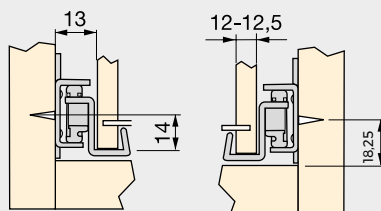

C - Sockets $\text{Ø}8 \times 8$ /C - Gniazda $\text{Ø}8 \times 8$

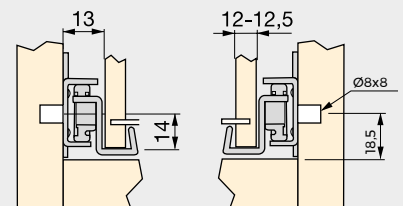

Set of ball bearing drawer runner with total extraction and soft close, height 45 mm
 Zestaw prowadnic kulkowych do szuflad, całkowity wysuw, cichy domyk, wysokość 45 mm



Longitude/Długość	Finishing/Wykończenie		Packaging/Opakowanie	Cod.
300	Black painted/Malowane na czarno	■	10 Pair/Kpl.	4301514
350	Black painted/Malowane na czarno	■	10 Pair/Kpl.	4301614
400	Black painted/Malowane na czarno	■	10 Pair/Kpl.	4301714
450	Black painted/Malowane na czarno	■	10 Pair/Kpl.	4301814
500	Black painted/Malowane na czarno	■	10 Pair/Kpl.	4301914
550	Black painted/Malowane na czarno	■	5 Pair/Kpl.	4302014
600	Black painted/Malowane na czarno	■	5 Pair/Kpl.	4302114

Steel/Stal

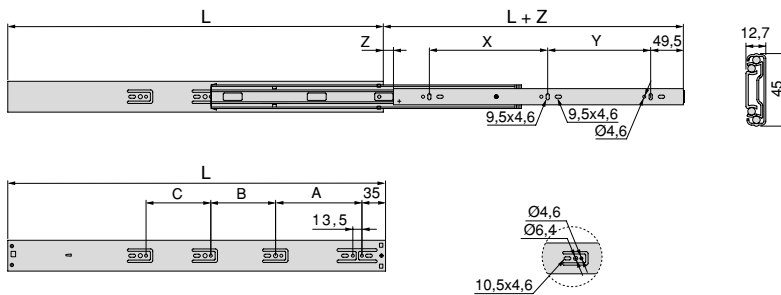

L	X	Y	Z	A	B	C
300	121,5	80	-14	96	-	-
350	122	128	-	72,5	55,5	-
400	160	128	10	128	55,5	-
450	160	160	10	128	96	-
500	192	192	10	128	96	64
550	224	224	8	128	96	64
600	256	256	8	128	96	128
650	256	256	8	128	96	128

Set of ball bearing runners with total extraction, height 45 mm
 Zestaw prowadnic kulkowych do szuflad, całkowity wysuw, 45 mm



Longitude/Długość	Finishing/Wykończenie		Packaging/Opakowanie	Cod.
250	Black painted/Malowane na czarno	■	15 Pair/Kpl.	4224014
300	Black painted/Malowane na czarno	■	15 Pair/Kpl.	4177114
350	Black painted/Malowane na czarno	■	15 Pair/Kpl.	4177214
400	Black painted/Malowane na czarno	■	15 Pair/Kpl.	4177314
450	Black painted/Malowane na czarno	■	15 Pair/Kpl.	4177414
500	Black painted/Malowane na czarno	■	15 Pair/Kpl.	4177514
600	Black painted/Malowane na czarno	■	15 Pair/Kpl.	4177614

Steel/Stal

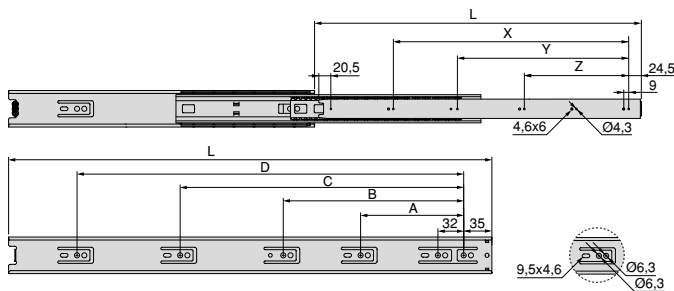

L	X	Y	Z	A	B	C	D
250	-	192	96	128	-	-	-
300	-	224	96	128	192	-	-
350	256	160	96	128	224	-	-
400	288	160	96	128	224	320	-
450	352	192	96	128	224	352	-
500	384	192	96	128	224	352	416
600	480	256	96	128	224	352	480
650	512	256	96	128	224	352	544

Hinges Zawiasy

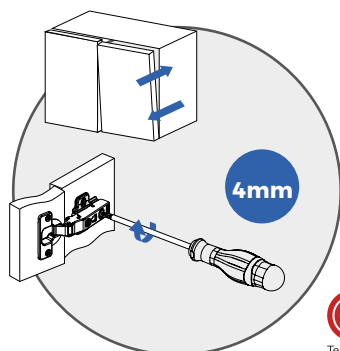

CATAS
Testing Certification Research



X91

Integrated soft closing mechanism.
Hinge to plate quick fixing system.
For 14 - 24 mm door thickness.
Adjustable in 3 dimensions.
Distance to cup bore edge $d = 3 - 7$ mm.
Depth adjustment by cam.
Spring in opening and closing.

Zintegrowany system cichego domyku.
Automatyczny system montażu zawiasu na prowadniku.
Do drzwi od grubości 14 - 24 mm.
Regulacja 3 wymiarów.
Odległość od krawędzi otworu puszkki $D = 3 - 7$ mm.
Mimośrodowa regulacja głębokości.
Zawias sprężynowy samozamykający i otwierający.

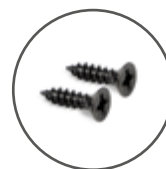

Hinges and supplements in titanium finish include screws in the same finish.

Zawiasy i dodatki w wykończeniu tytanowym zawierają śruby w tym samym wykończeniu.



Hinges X91 with soft closing / Zawiasy X91 z cichym domykiem
 105° HINGES X91 WITH Ø35 CUP /
 ZAWIASY X91 PUSZKOWE Z PUSZKĄ Ø35, KĄT OTWARCIA 105°

Full overlay hinge X91 with soft close

Zawias w pełni nakładany X91 z cichym domykiem



Description/Opis	Finishing/Wykończenie	Packaging/Opakowanie	Cod.
Screw-on/Przykręcane	Titanium/Tytanowy	200 Unit/Szt	1040052
Screw-on/Przykręcane	Titanium/Tytanowy	200 Unit/Szt	1040152

Steel/Stal

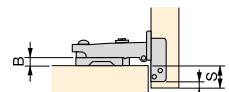
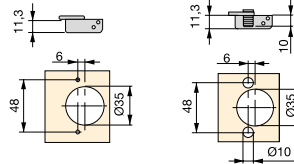

$$B = 15 + D - S$$

Half overlay hinge X91 with soft close

Zawias w połowie nakładany X91 z cichym domykiem



Description/Opis	Finishing/Wykończenie	Packaging/Opakowanie	Cod.
Screw-on/Przykręcane	Titanium/Tytanowy	200 Unit/Szt	1040252
Screw-on/Przykręcane	Titanium/Tytanowy	200 Unit/Szt	1040352

Steel/Stal

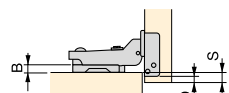
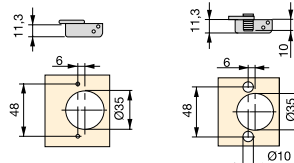

$$B = 5 + D - S$$

Inset hinge X91 with soft close

Zawias wpuszczany X91 z cichym domykiem



Description/Opis	Finishing/Wykończenie	Packaging/Opakowanie	Cod.
Screw-on/Przykręcane	Titanium/Tytanowy	200 Unit/Szt	1040452
Screw-on/Przykręcane	Titanium/Tytanowy	200 Unit/Szt	1040552

Steel/Stal

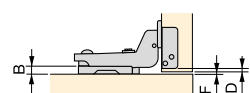
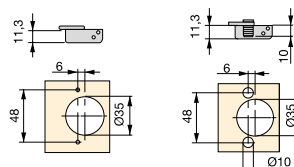

$$B = D + F - 4$$

Hinges X91 with soft closing / Zawiasy X91 z cichym domykiem
105° HINGES X91 WITH Ø35 CUP /
ZAWIASY X91 PUSZKOWE Z PUSZKĄ Ø35, KĄT OTWARCIA 105°

Integrated soft closing mechanism.
 Hinge to plate quick fixing system.
 For 14 - 24 mm door thickness.
 Adjustable in 3 dimensions.
 Distance to cup bore edge D = 3 - 7 mm.
 Depth adjustment by cam.
 Spring in opening and closing.

Zintegrowany mechanizm cichego domyku.
 System szybkiego mocowania zawiasu na prowadniku.
 Do drzwi o grubości 14 - 24 mm.
 Regulowany w 3 wymiarach.
 Odległość od krawędzi otworu puszką D = 3 - 7 mm.
 Mimośrodowa regulacja głębokości.
 Zawias sprężynowy samozamykający i otwierający.

45° hinge X91 with soft close
Zawias 45° z cichym domykiem



Description/Opis	Finishing/Wykończenie	Packaging/Opakowanie	Cod.
Screw-on/Przykręcane	Titanium/Tytanowy	200 Unit/Szt	1040652

Steel/Stal

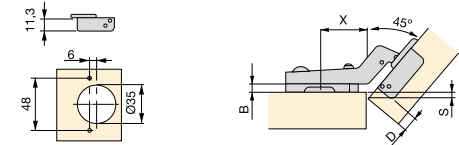
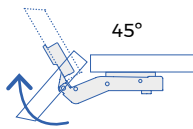

B	D			
	4	5	6	7
0	37 4,5	36 5,4	35 6,3	34 7,2
2	37 2,5	36 3,4	35 4,3	34 5,2
4	37 0,5	36 1,4	35 2,3	34 3,2
	X			S

90° hinge X91 with soft close
Zawias 90° z cichym domykiem



Description/Opis	Finishing/Wykończenie	Packaging/Opakowanie	Cod.
Screw-on/Przykręcane	Titanium/Tytanowy	200 Unit/Szt	1040752

Steel/Stal

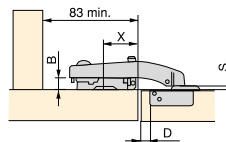
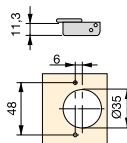
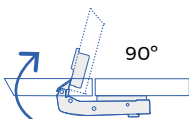

B	D	
	4	5
0	20 2,8	19 2,8
2	20 0,8	19 0,8
4	20 -1,2	19 -1,2
	X S	

Hinges X91 with soft closing / Zawiasy X91 z cichym domykiem
105° HINGES X91 WITH Ø35 CUP /
ZAWIASY X91 PUSZKOWE Z PUSZKĄ Ø35, KĄT OTWARCIA 105°

Integrated soft closing mechanism.
 Hinge to plate quick fixing system.
 For 14 - 24 mm door thickness.
 Adjustable in 3 dimensions.
 Distance to cup bore edge D = 3 - 7 mm.
 Depth adjustment by cam.
 Spring in opening and closing.

Zintegrowany mechanizm cichego domyku.
 System szybkiego mocowania zawiasu na prowadniku.
 Do drzwi o grubości 14 - 24 mm.
 Regulowany w 3 wymiarach.
 Odległość od krawędzi otworu puszkę D = 3 - 7 mm.
 Mimośrodowa regulacja głębokości.
 Zawias sprężynowy samozamykający i otwierający.

Full overlay hinge 165° X91 with soft close
Zawias w pełni nakładany z cichym domykiem



Description/Opis	Finishing/Wykończenie	Packaging/Opakowanie	Cod.
Screw-on/Przykręcane	Titanium/Tytanowy	100 Unit/Szt	1042852

Steel/Stal

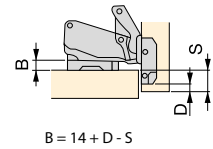
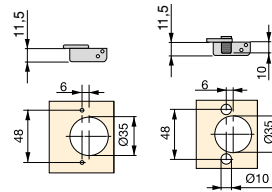

Half overlay hinge 165° X91 with soft close
Zawias w połowie nakładany z cichym domykiem



Description/Opis	Finishing/Wykończenie	Packaging/Opakowanie	Cod.
Screw-on/Przykręcane	Titanium/Tytanowy	100 Unit/Szt	1042952

Steel/Stal

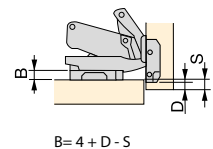
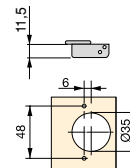

Inset hinge 165° X91 with soft close
Zawias wpuszczany z cichym domykiem



Description/Opis	Finishing/Wykończenie	Packaging/Opakowanie	Cod.
Screw-on/Przykręcane	Titanium/Tytanowy	100 Unit/Szt	1043052

Steel/Stal

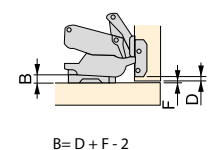
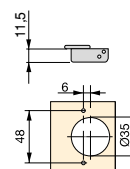

Hinges X91 with soft closing / Zawiasy X91 z cichym domykiem
105° CUP HINGES X91 FOR ALUMINIUM PROFILES /
ZAWIASY X91 DO PROFILI Z ALUMINIUM, KĄT OTWARCIA 105°



Integrated soft closing mechanism.
 Hinge to plate quick fitting system.
 For 19 - 24 mm door thickness.
 Adjustable in 3 dimensions.
 Depth adjustment by cam.
 Spring in opening and closing.

Zintegrowany system cichego domyku.
 System szybkiego mocowania zawiasu na prowadniku.
 Do drzwi o grubości 19 - 24 mm.
 Regulowany w 3 wymiarach.
 Mimośrodowa regulacja głębokości.
 Zawias sprężynowy samozamykający i otwierający.

Full overlay hinge X91 for aluminium profiles
Zawias w pełni nakładany X91



Description/Opis	Finishing/Wykończenie	Packaging/Opakowanie	Cod.
Screw-on/Przykręcane	Titanium/Tytanowy	200 Unit/Szt	1046052

Steel, Zamak / Stal, Znal

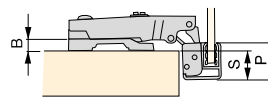
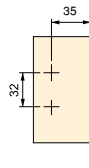

$$B = P - 2 - S$$

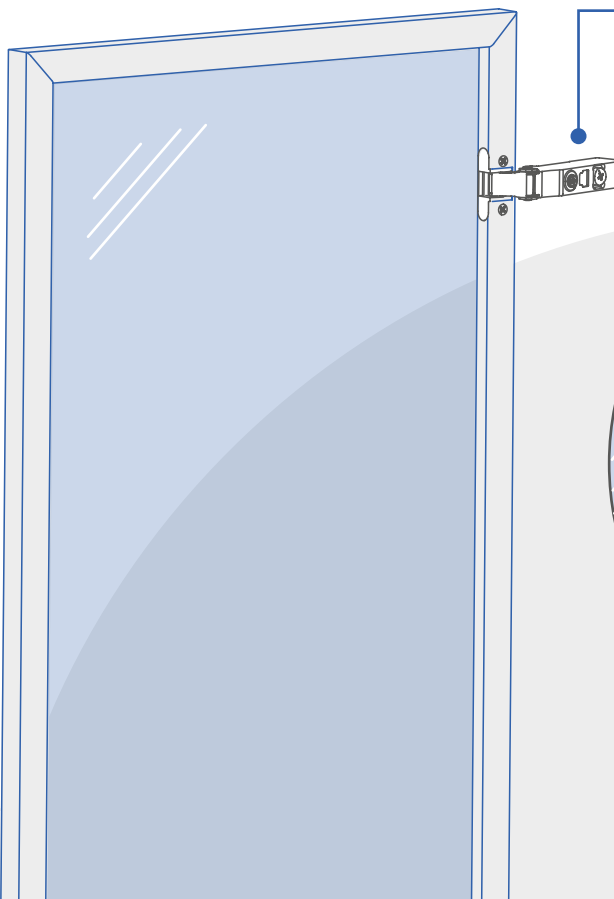

- 1046107 - NORMAL
- 1046007 - SOFT
- 1046052 - SOFT

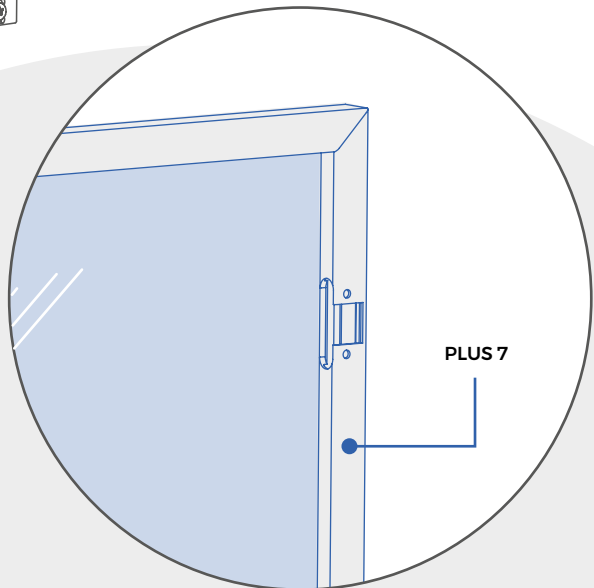
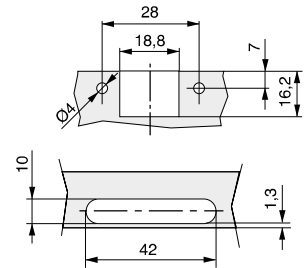

X91N Hinges / Zawiasy X91N

105° HINGES X91N WITH Ø35 CUP / ZAWIASY X91N PUSZKOWE Z PUSZKĄ Ø35, KĄT OTWARCIA 105°

Hinge to plate quick fixing system.
For 14 - 24 mm door thickness.
Adjustable in 3 dimensions.
Distance to cup bore edge $D = 3 - 7$ mm.
Depth adjustment by cam.
Spring in the closing direction.

System szybkiego mocowania zawiasu na prowadniku.
Do drzwi o grubości 14 - 24 mm.
Regulowany w 3 wymiarach.
Odległość od krawędzi otworu puszkę $D = 3 - 7$ mm.
Mimośrodowa regulacja głębokości.
Zawias sprężynowy samozamykający.

Full overlay hinge X91N Zawias w pełni nakładany



Description/Opis	Finishing/Wykończenie	Packaging/Opakowanie	Cod.
Screw-on/Przykręcane	Titanium/Tytanowy	200 Unit/Szt	1040852
Screw-on/Przykręcane	Titanium/Tytanowy	200 Unit/Szt	1043552

Steel/Stal

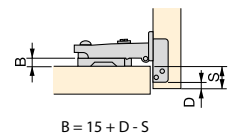
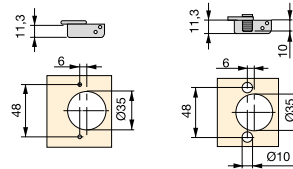

Half overlay hinge X91N Zawias w połowie nakładany



Description/Opis	Finishing/Wykończenie	Packaging/Opakowanie	Cod.
Screw-on/Przykręcane	Titanium/Tytanowy	200 Unit/Szt	1040952
Screw-on/Przykręcane	Titanium/Tytanowy	200 Unit/Szt	1043652

Steel/Stal

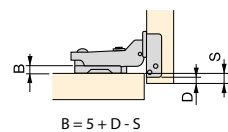
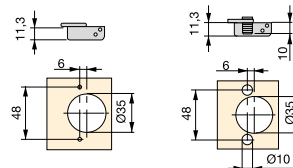

Inset hinge X91N Zawias wpuszczany



Description/Opis	Finishing/Wykończenie	Packaging/Opakowanie	Cod.
Screw-on/Przykręcane	Titanium/Tytanowy	200 Unit/Szt	1041052
Screw-on/Przykręcane	Titanium/Tytanowy	200 Unit/Szt	1043752

Steel/Stal

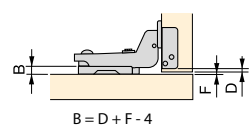
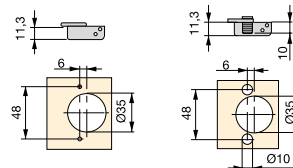

X91N Hinges / Zawiasy X91N

X91N 105° SLIDE-ON UNSPRUNG HINGES WITH Ø35 CUP /

ZAWIASY X91N PUSZKOWE Z PUSZKĄ Ø35, BEZ SPRĘŻYNY POWROTNEJ KĄT OTWARCIA 105°



Hinges compatible with magnetic locks.
Hinge to plate quick fixing system.
For 14 - 24 mm door thickness.
Adjustable in 3 dimensions.
Distance to cup bore edge D = 3 - 7 mm.
Depth adjustment by cam.

Zawiasy kompatybilne z zamknięciem magnetycznym.
System szybkiego mocowania zawiasu na prowadniku.
Do drzwi o grubości 14 - 24 mm.
Regulowany w 3 wymiarach.
Odległość od krawędzi otworu puszkę D = 3 - 7 mm.
Mimośrodowa regulacja głębokości.

Full overlay hinge X91N unsprung

Zawias prosty X91N bez sprężyny



Description/Opis	Finishing/Wykończenie	Packaging/Opakowanie	Cod.
Screw-on/Przykręcane	Titanium/Tytanowy	200 Unit/Szt	1044052

Steel/Stal

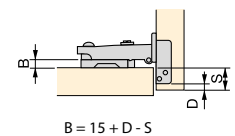
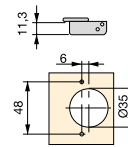

Half overlay hinge X91N unsprung

Zawias kolankowy X91N bez sprężyny



Description/Opis	Finishing/Wykończenie	Packaging/Opakowanie	Cod.
Screw-on/Przykręcane	Titanium/Tytanowy	200 Unit/Szt	1044152

Steel/Stal

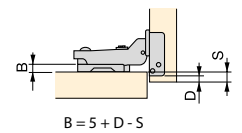
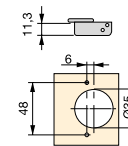

Inset hinge X91N unsprung

Zawias kolankowy super X91N bez sprężyny



Description/Opis	Finishing/Wykończenie	Packaging/Opakowanie	Cod.
Screw-on/Przykręcane	Titanium/Tytanowy	200 Unit/Szt	1044252

Steel/Stal

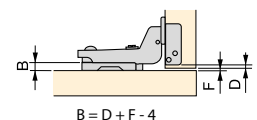
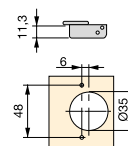

X91N Hinges / Zawiasy X91N

165° HINGES X91N WITH Ø35 CUP / ZAWIASY X91N PUSZKOWE Z PUSZKĄ Ø35, KĄT OTWARCIA 165°

Hinge to plate quick fixing system.
For 14 - 26 mm door thickness.
Adjustable in 3 dimensions.
Distance to cup bore edge $D = 3 - 7$ mm.
Depth adjustment by cam.
Spring in the closing direction.

System szybkiego mocowania zawiasu na prowadniku.
Do drzwi o grubości 14 - 26 mm.
Regulowany w 3 wymiarach.
Odległość od krawędzi otworu puszki $D = 3 - 7$ mm.
Mimośrodowa regulacja głębokości.
Zawias sprężynowy samozamykający.

Full overlay hinge 165° X91N

Zawias prosty 165° X91N



Description/Opis	Finishing/Wykończenie	Packaging/Opakowanie	Cod.
Screw-on/Przykręcane	Titanium/Tytanowy	100 Unit/Szt	1044552

Steel/Stal

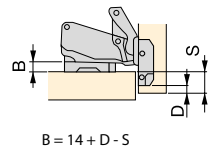
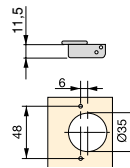

Inset hinge 165° X91N

Zawias kolankowy super 165° X91N



Description/Opis	Finishing/Wykończenie	Packaging/Opakowanie	Cod.
Screw-on/Przykręcane	Titanium/Tytanowy	100 Unit/Szt	1044752

Steel/Stal

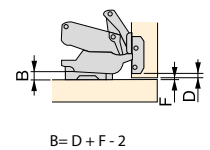
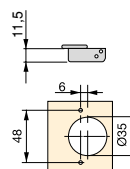

Supplement for hinge Plate X91/X92 with eccentric regulation screw-on
 Przykręcany prowadnik z regulacją mimośrodową X91/X92

Height/Wysokość	Finishing/Wykończenie	Packaging/Opakowanie	Cod.
0	Titanium/Tytanowy	200 Unit/Szt	1047052
2	Titanium/Tytanowy	200 Unit/Szt	1047152
4	Titanium/Tytanowy	200 Unit/Szt	1047252

Steel/Stal

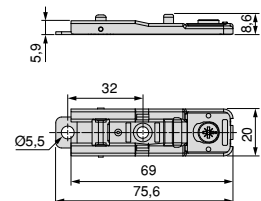
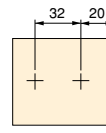

Supplement for hinge Plate X91/X92 with eccentric regulation knock-in
 Prowadnik wciskany z regulacją mimośrodową X91/X92

Height/Wysokość	Finishing/Wykończenie	Packaging/Opakowanie	Cod.
0	Titanium/Tytanowy	200 Unit/Szt	1047352
2	Titanium/Tytanowy	200 Unit/Szt	1047452
4	Titanium/Tytanowy	200 Unit/Szt	1047552

Steel/Stal

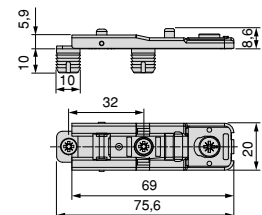
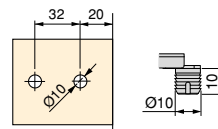

Plastic hinge cover
 Plastikowe osłony zawiasów

Finishing/Wykończenie	Packaging/Opakowanie	Cod.
Titanium plastic/Plastik tytanowy	200 Unit/Szt	1047638

Plastic/Plastik

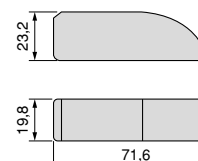

Supplement for hinge Screw-on X91/X92 plate
 Przykręcany prowadnik X91/X92

Height/Wysokość	Finishing/Wykończenie	Packaging/Opakowanie	Cod.
0	Titanium/Tytanowy	200 Unit/Szt	1041152
2	Titanium/Tytanowy	200 Unit/Szt	1041252

Steel/Stal

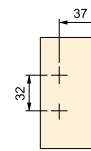

Supplement for hinge Knock-in X91/X92 plate
 Prowadnik wciskany X91/X92

Height/Wysokość	Finishing/Wykończenie	Packaging/Opakowanie	Cod.
0	Titanium/Tytanowy	200 Unit/Szt	1042252
2	Titanium/Tytanowy	200 Unit/Szt	1042352

Steel/Stal

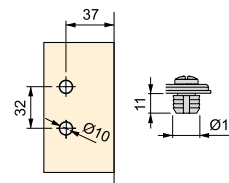

Supplement for hinge Mixed mounting X91/X92 plate
 Prowadnik mieszane mocowanie X91/X92

Height/Wysokość	P	Finishing/Wykończenie	Packaging/Opakowanie	Cod.
0	7.8	Titanium/Tytanowy	200 Unit/Szt	1043352
2	7.8	Titanium/Tytanowy	200 Unit/Szt	1043452
4	7.8	Titanium/Tytanowy	200 Unit/Szt	1043952

Steel/Stal

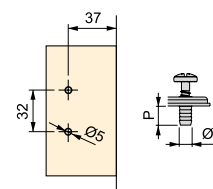

Supplement for hinge Plate X91/X92 with eccentric regulation screw-on
 Przykręcany prowadnik z regulacją mimośrodową X91/X92

Height/Wysokość	Finishing/Wykończenie	Packaging/Opakowanie	Cod.
0	Titanium/Tytanowy	200 Unit/Szt	1041552
2	Titanium/Tytanowy	200 Unit/Szt	1041652

Steel/Stal

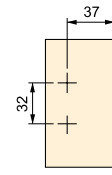

Supplement for hinge Plate X91/X92 with eccentric regulation knock-in
 Prowadnik wciskany z regulacją mimośrodową X91/X92

Height/Wysokość	Finishing/Wykończenie	Packaging/Opakowanie	Cod.
0	Titanium/Tytanowy	200 Unit/Szt	1042752
2	Titanium/Tytanowy	200 Unit/Szt	1043852

Steel/Stal

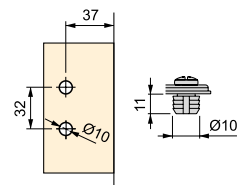

Supplement for hinge Plate X91/X92 with eccentric regulation Euro screw
 Prowadnik Euro z regulacją mimośrodową X91/X92

Height/Wysokość	Finishing/Wykończenie	Packaging/Opakowanie	Cod.
0	Titanium/Tytanowy	200 Unit/Szt	1041752
2	Titanium/Tytanowy	200 Unit/Szt	1041852
4	Titanium/Tytanowy	200 Unit/Szt	1046852

Steel/Stal

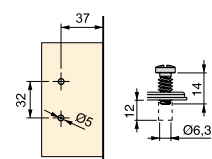

Cover plate steel for hinged doors
 Stalowa listwa ozdobna do drzwi skrzydłowych

Finishing/Wykończenie	Packaging/Opakowanie	Cod.
Titanium/Tytanowy 	1000 Unit/Szt	1044852

Steel/Stal



- Valid for Hinges: X91/X91N, X91R, X92/X92N and X95
- Dotyczy zawiasów: X91/X91N, X91R, X92/X92N i X95.

Cover plate steel X91 for hinged doors
 Osłona X91 do drzwi skrzydłowych

Finishing/Wykończenie	Packaging/Opakowanie	Cod.
Titanium/Tytanowy 	1000 Unit/Szt	1044952

Steel/Stal



- Valid for Hinges: X91/X91N, X91R, X92/X92N and X95
- Dotyczy zawiasów: X91/X91N, X91R, X92/X92N i X95.



Ankor GT-B hinge
Zawias Ankor GT-B



Finishing/Wykończenie	Packaging/Opakowanie	Cod.
Nickel plated/Niklowane	20 Unit/Szt	1010707

Zamak/Znal

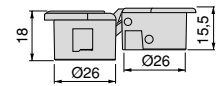
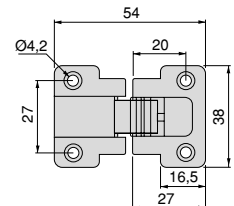
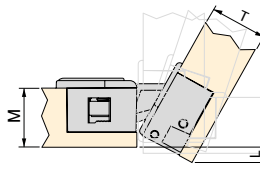

- Three-dimensional adjustment of 2 mm.
- Regulacja trójwymiarowa o 2 mm.

L	T						
	18	20	22	24	25	26	
M	18	-	-	1,7	3,7	4,7	5,7
	20	-	-	-	1,7	2,7	3,7
	22	-	-	-	-	0,7	1,7

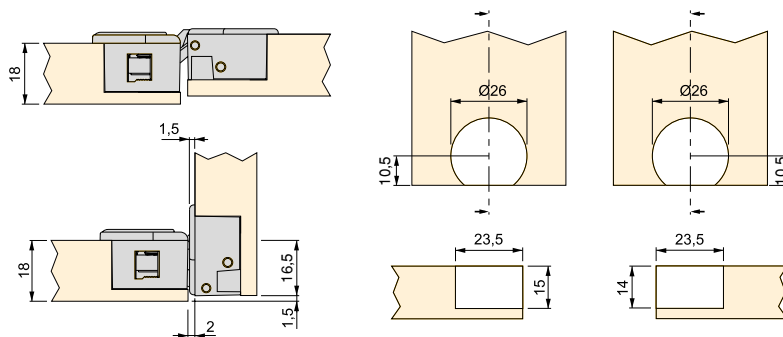

Ankor GT-B cover
Zaślepka do zawiasu Ankor GT-B

Finishing/Wykończenie	Packaging/Opakowanie	Cod.
Black plastic/Czarny plastik	20 Unit/Szt	1010817

Plastic/Plastik



Drop-absorbing compass For folding SDS
Podnośnik gazowy Zwijany SDS



Force/Siła	Finishing/Wykończenie	Packaging/Opakowanie	Cod.
5-12 Kg x cm	Black plastic/Czarny plastik	20 Unit/Szt	1000717
10-24 Kg x cm	Black plastic/Czarny plastik	20 Unit/Szt	1000617

Plastic, Steel/Plastik, Stal

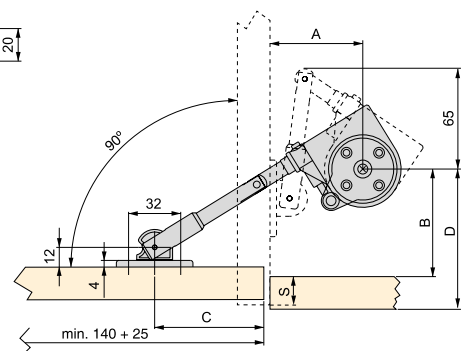
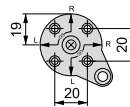
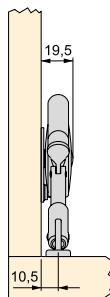

	A	B	C	D
	57	66	48 + S	66 + S

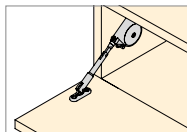

Mechanism for swing doors Mechanizm drzwiowy

SLIMWINCH

Steel cable folding door mechanism. It can be surface mounted or recessed into the side of the module, integrating it and reducing its visual impact. It also features a damped opening system, closing assistance and adjustment of the cable length and spring force.

Steel cable folding door mechanism. It can be surface mounted or recessed into the side of the module, integrating it and reducing its visual impact. It also features a damped opening system, closing assistance and adjustment of the cable length and spring force.



Mechanism for swing doors Slimwinch Mechanizm drzwiowy Slimwinch z zawiasami



Force/Siła	Finishing/Wykończenie		Packaging/Opakowanie	Cod.
4 kg	Black plastic/Czarny plastik	■	10 Unit/Szt	1027417
6 kg	Black plastic/Czarny plastik	■	10 Unit/Szt	1027517
10 kg	Black plastic/Czarny plastik	■	10 Unit/Szt	1027617
14 kg	Black plastic/Czarny plastik	■	10 Unit/Szt	1027717

Plastic/Plastik

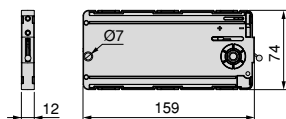
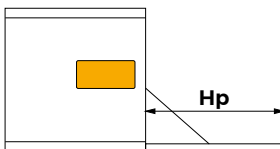

Hp	4 kg		6 kg		10 kg		14 kg	
	x1	x2	x1	x2	x1	x2	x1	x2
200 - 230	2,6 - 3,4	5,2 - 6,8	3,4 - 4,4	6,2 - 8,4	4,5 - 6,2	8,4 - 11,6	5,5 - 7,4	11,6 - 14,8
230 - 270	2,2 - 2,8	4,8 - 6	2,8 - 3,9	5,6 - 7,3	4 - 5,4	7,6 - 10,7	5,3 - 7,4	9,9 - 12,4
270 - 330	2,3 - 2,7	4,1 - 5,3	2,7 - 3,3	4,7 - 6,1	3,4 - 5,2	6,2 - 8,7	4,7 - 6,1	8,4 - 11
330 - 380	-	3,6 - 4,2	2,3 - 2,7	4 - 5,4	3 - 4,6	5,6 - 7,8	4 - 5,6	7,8 - 10,4
380 - 430	-	3,5 - 4,4	2,4 - 2,9	4,2 - 5,6	3,1 - 4,1	5,7 - 7,3	4,1 - 4,9	7,9 - 10,3
430 - 460	-	3 - 3,8	2 - 2,5	3,6 - 5,1	2,5 - 3,4	5,1 - 7,2	3,9 - 5,2	7,2 - 8,7
460 - 480	-	3,3 - 3,9	1,8 - 2,6	3,9 - 4,9	2,7 - 3,2	5 - 7,1	3,6 - 4,4	7 - 8,6
480	-	3,1 - 3,8	1,8 - 2,6	3,7 - 4,9	2,6 - 3,2	4,9 - 7,1	3,7 - 4,5	6,4 - 8,7

Cover cap Slimwinch for recessed mounting

Nakładka wykończeniowa Slimwinch do montażu podtynkowego

Finishing/Wykończenie	Packaging/Opakowanie	Cod.
Black plastic/Czarny plastik	10 Unit/Szt	1027917

Plastic/Plastik

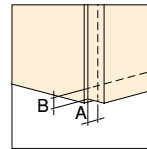
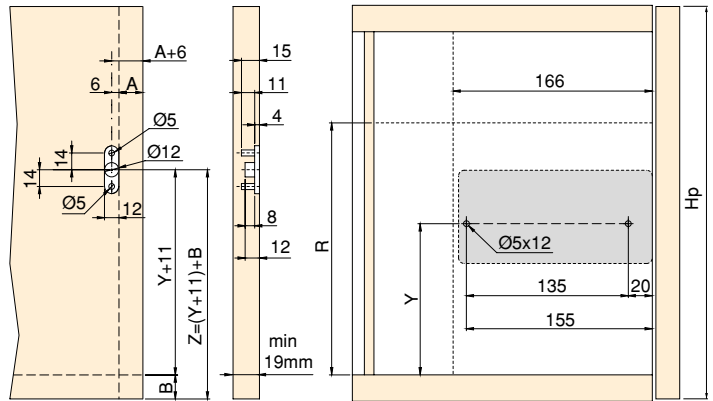
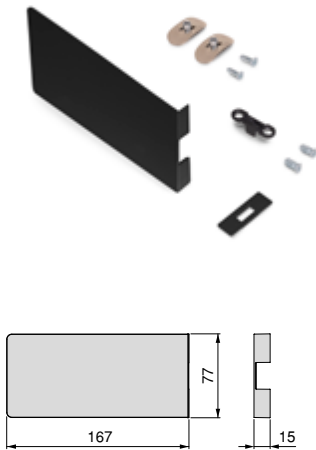

Hp	Y	R
200 - 270	126	176
270 - 430	150	200
430 - 480	160	210

Cover cap Slimwinch for surface mounting

Nakładka maskująca Slimwinch do montażu natynkowego

Finishing/Wykończenie	Packaging/Opakowanie	Cod.
Black plastic/Czarny plastik	10 Unit/Szt	1027817

Plastic/Plastik

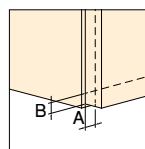
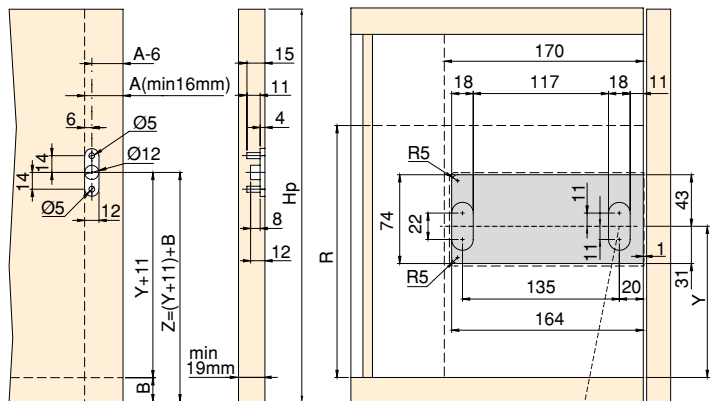
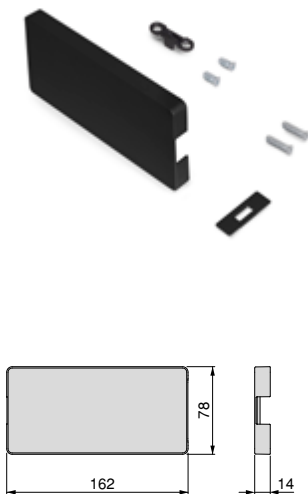

Hp	Y	R
200 - 270	126	176
270 - 430	150	200
430 - 480	160	210

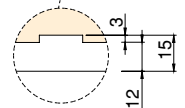

UNICO

Integrated hinged folding door system with soft opening and assisted closing. Can be recessed into the side of the unit or surface mounted. Allows the depth, height and lateral movement of the edge to be adjusted, as well as the strength of the system.

Zintegrowany system drzwi składanych na zawiasach z miękkim otwieraniem i wspomaganym zamykaniem. Może być wpuszczony w bok urządzenia lub zamontowany na powierzchni. Umożliwia regulację głębokości, wysokości i ruchu bocznego krawędzi, a także wytrzymałości systemu.

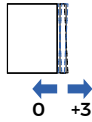
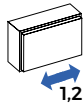
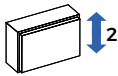

Mechanism for swing doors Unico Mechanizm drzwiowy z zawiasami Unico



Description/Opis	Finishing/Wykończenie		Packaging/Opakowanie	Cod.
Low/Low	Black zinc plated/Cynkowana czerń	■	1 Unit/Szt	1028209
Medium/Medium	Black zinc plated/Cynkowana czerń	■	1 Unit/Szt	1028309
High/High	Black zinc plated/Cynkowana czerń	■	1 Unit/Szt	1028409
Extra High/Extra High	Black zinc plated/Cynkowana czerń	■	1 Unit/Szt	1028509

Steel, Zamak / Stal, Znal

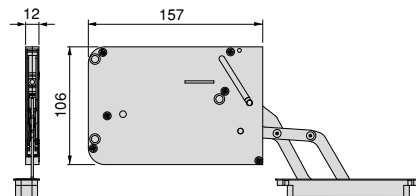

Cover cap Unico for recessed mounting

Nakładka maskująca Unico do montażu podtynkowego

Finishing/Wykończenie	Packaging/Opakowanie	Cod.
Black plastic/Czarny plastik 	1 Unit/Szt	1028717

Plastic/Plastik

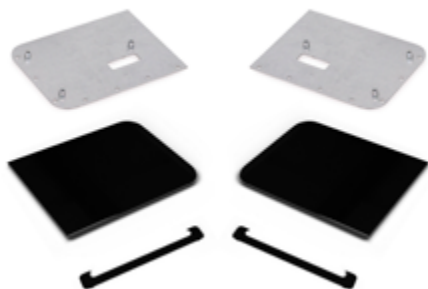

Cover cap Unico for surface mounting

Pokrywa maskująca Unico do montażu natynkowego

Finishing/Wykończenie	Packaging/Opakowanie	Cod.
Black plastic/Czarny plastik 	1 Unit/Szt	1028617

Plastic/Plastik

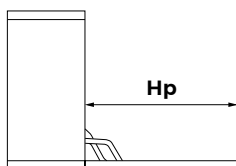
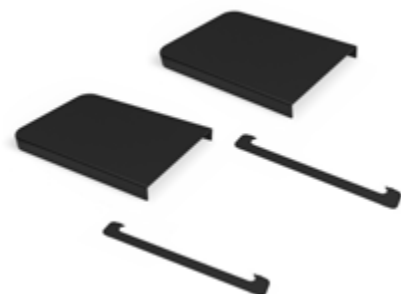

Hp	LOW	MEDIUM	HIGH	EXTRA HIGH
180 - 230	3,0 - 4,7	4,8 - 6,7	6,8 - 8,5	-
230 - 270	2,5 - 3,7	3,8 - 5,5	5,6 - 7,5	7,6 - 10,0
270 - 330	2,0 - 3,4	3,5 - 4,9	5,0 - 6,4	6,5 - 9,4
330 - 380	2,0 - 2,8	2,9 - 4,2	4,3 - 5,5	5,6 - 7,6
380 - 430	-	2,5 - 3,6	3,7 - 4,7	4,8 - 6,9
430 - 480	-	2,0 - 2,9	3,0 - 4,0	4,1 - 6,0

Spring for lift-up door Agile
Zestaw do drzwi podnoszonych Agile



Description/Opis	Force/Siła	Finishing/Wykończenie	Packaging/Opakowanie	Cod.
Low/Low	580 - 1250	Anthracite grey plastic/Szaro-antracytowy plastik	1 KIT/KIT	1213023
Medium/Medium	960 - 2040	Anthracite grey plastic/Szaro-antracytowy plastik	1 KIT/KIT	1213123
High/High	1800 - 3500	Anthracite grey plastic/Szaro-antracytowy plastik	1 KIT/KIT	1213223
Extra High/Extra High	3200 - 9000	Anthracite grey plastic/Szaro-antracytowy plastik	1 KIT/KIT	1213523

Acero, Plástico/Aço, Plástico

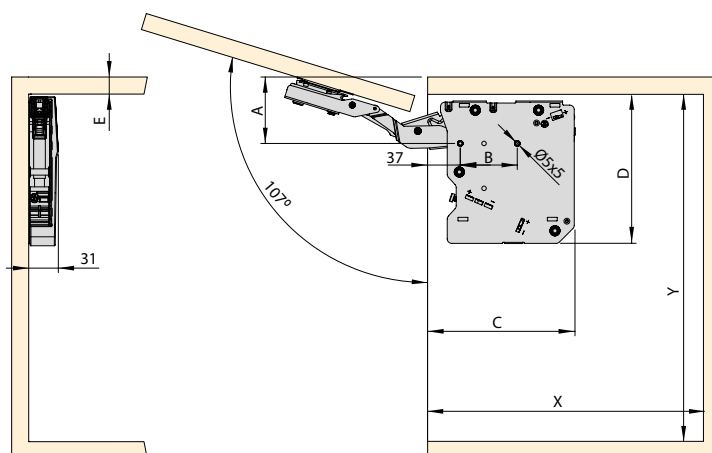

	F	A	B	C	D	E	X	Y
LOW	580 - 1.250	74	64	180	168	Max. 22	Min. 240	Min. 200
MEDIUM	960 - 2.040	74	64	180	168	Max. 22	Min. 240	Min. 200
HIGH	1.800 - 3.500	74	64	180	168	Max. 22	Min. 240	Min. 200
EXTRA HIGH	3.200 - 9.000	96	128	200	158	Max. 26	Min. 261	Min. 170

Compass for lift gates Agile Flap

Podnośnik gazowy do frontów meblowych Agile Flap

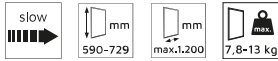

Modelo/Modelo	P	Finishing/Wykończenie	Packaging/Opakowanie	Cod.
H59 M/H59 M	7,8 - 13 kg	Anthracite grey plastic/Szaro-antracytowy plastik	1 KIT/KIT	1213923
H65 M/H65 M	3,7 - 7,2 kg	Anthracite grey plastic/Szaro-antracytowy plastik	1 KIT/KIT	1214023
H65 L/H65 L	7 - 11,6 kg	Anthracite grey plastic/Szaro-antracytowy plastik	1 KIT/KIT	1214123

Steel/Stal

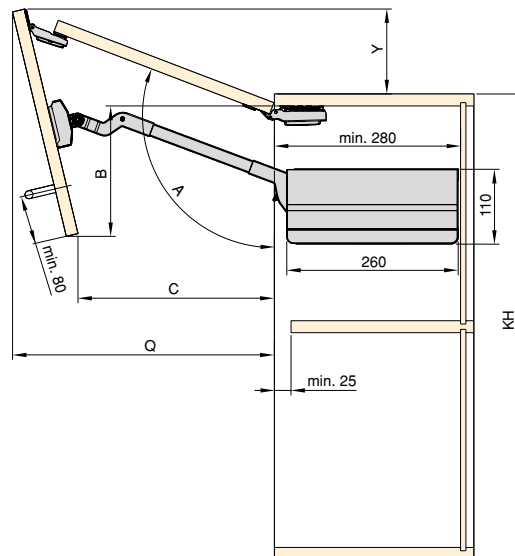
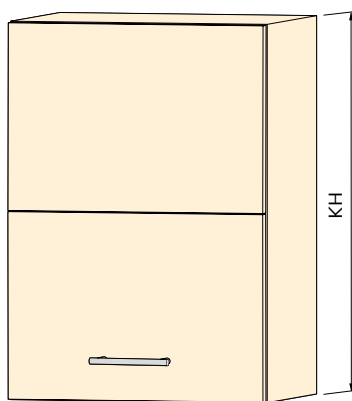

	KH (mm)	P (kg)
H59 M	590 - 649	7,8 - 13
H65 L	650 - 729	3,7 - 7,2
H65 M		7 - 11,6

	A	B	C	Q	Y
H59 M	-115-105°	141-194	308-224	327-384	132-84
H65 L	-115-102°	160-228	335-226	355-428	144-74
H65 M					

Latches and locks Zamki i zamknięcia

Locks for push-to-open doors, no handle required.

Zamki do drzwi otwieranych przez naciśnięcie, bez klamki.

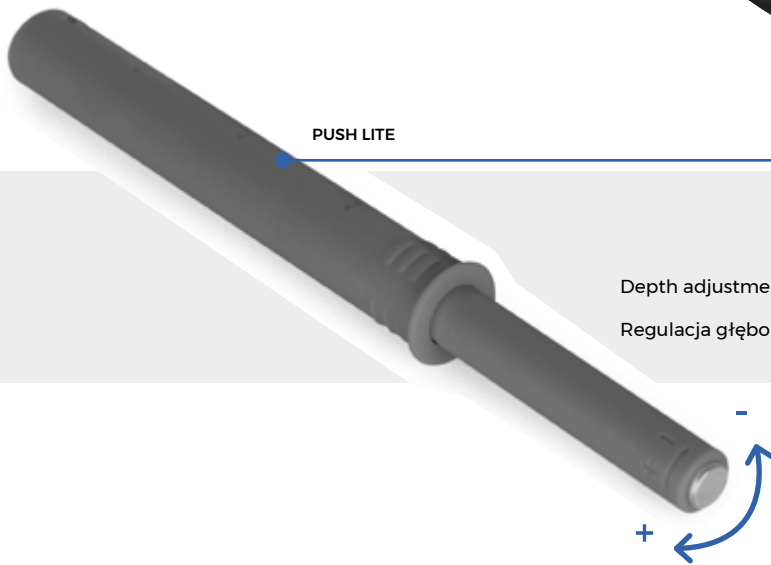

PUSH LITE

Depth adjustment from -1 mm to +5 mm

Regulacja głębokości od -1 mm do +5 mm

Push Lite mounting, flush-mounted and to screw into the cabinet.

Montaż typu Push Lite, podtynkowy i do przykręcenia w szafce.

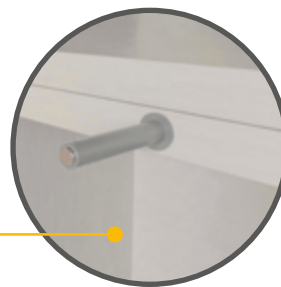

Push Latch door lock for screwing onto furniture in black finish.

Zamek drzwiowy Push Latch do przykręcenia do mebli w czarnym wykończeniu.

Push Lite door closer to be recessed to the cabinet with adjustment, 70 mm
 Samozamykacz Push Lite do przykręcenia w meblu z regulacją, 70 mm



Description/Opis	Finishing/Wykończenie	Packaging/Opakowanie	Cod.
Bumper/Odbojnik	Anthracyte grey plastic/Szaro-antracytowy plastik	50 Unit/Szt	1900023
Magnetic 2.5 kg/Magnetyczne 2,5 kg	Anthracyte grey plastic/Szaro-antracytowy plastik	50 Unit/Szt	1900123

Plastic/Plastik

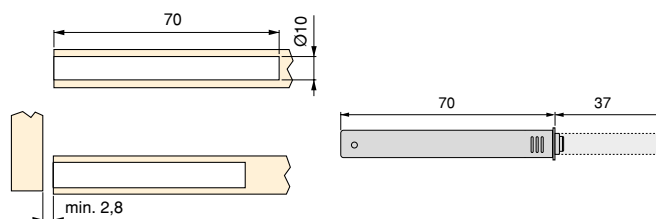

Push Latch door closer to be recessed to the cabinet with adjustment, 80 mm
 Zamknięcie Odbojnik Push Latch regulowany, 80 mm

Description/Opis	Finishing/Wykończenie	Packaging/Opakowanie	Cod.
Bumper/Odbojnik	Anthracyte grey plastic/Szaro-antracytowy plastik	100 Unit/Szt	1908323
Magnético 1,2 Kg/Magnético 1,2 kg	Anthracyte grey plastic/Szaro-antracytowy plastik	100 Unit/Szt	1908423

Plastic/Plastik

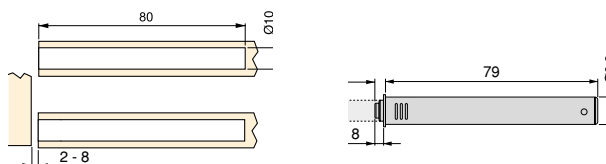

Support and cover to be screwed for Push Latch, 76,5 and 80 mm
 Uchwyt do Push Latch, 76,5 e 80 mm

Finishing/Wykończenie	Packaging/Opakowanie	Cod.
Anthracite grey plastic/Szaro-antracytowy plastik 	100 Unit/Szt	2005123

Plastic/Plastik

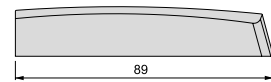
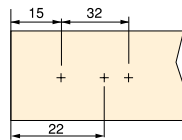

Push Lite door closer to be screwed to the cabinet with adjustment, 80 mm
 Samozamykacz Push Lite do przykręcenia w meblu z regulacją, 80 mm

Description/Opis	Finishing/Wykończenie	Packaging/Opakowanie	Cod.
Bumper/Odbojnik	Anthracite grey plastic/Szaro-antracytowy plastik 	50 Unit/Szt	1900223
Magnetic 2,5 kg/Magnetyczne 2,5 kg	Anthracite grey plastic/Szaro-antracytowy plastik 	50 Unit/Szt	1900323

Plastic/Plastik

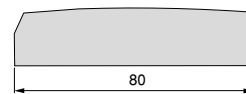
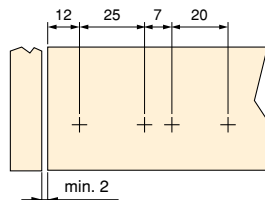

Push Latch door closer to be screwed to the cabinet, 62 mm
Przykręcany odbiojnik Push Latch, 62 mm

Description/Opis	Finishing/Wykończenie	Packaging/Opakowanie	Cod.
Bumper/Odbojnik	Black plastic/Czarny plastik	50 Unit/Szt	2033817
Magnético 3,5 Kg/Magnetico 3,5 kg	Black plastic/Czarny plastik	50 Unit/Szt	2033917

Plastic/Plastik

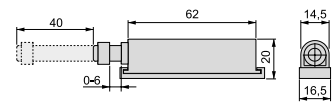
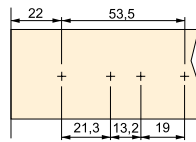

Oval strike for surface for magnetic closure

Prostokątny prowadnik do zamknięć magnetycznych do zamknięcia magnetycznego

Finishing/Wykończenie	Packaging/Opakowanie	Cod.
Zinc plated/Cynkowane	400 Unit/Szt	2030905

Steel/Stal

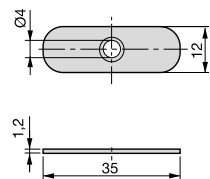

Square strike for surface for magnetic closure

Kwadratowa płytko do zamknięcia magnetycznego

Finishing/Wykończenie	Packaging/Opakowanie	Cod.
Nickel plated/Niklowane	1000 Unit/Szt	1050007

Steel/Stal

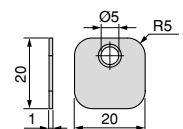

Zero modular structure Zero modułowa struktura

A simple, functional and design-oriented system.
Prosty, funkcjonalny i zorientowany na design system.

wall system / system ścienny



ceiling system / system sufitowy



Try the configurator on our website / Wypróbuj konfigurator na naszej stronie internetowej:
<https://www.emuca.com/configurator#/zero>

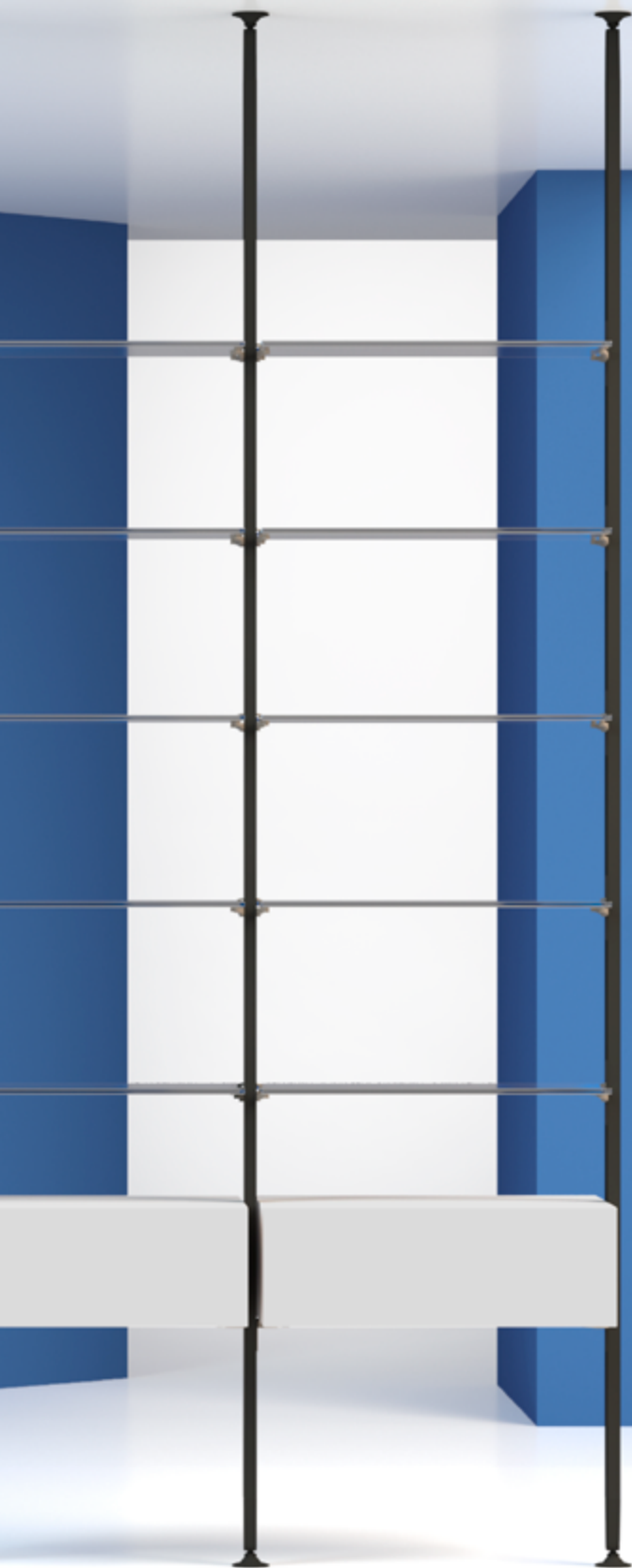

The Zero modular structure is designed to make your life easier, offering infinite possibilities for the home, dressing rooms, offices or shops. Its name is related to its main features: Zero time, Zero tools and Zero difficulties.

Modułowa struktura Zero została zaprojektowana, aby ułatwić życie, oferując nieskończone możliwości dla domu, garderoby, biura lub sklepu. Jej nazwa związana jest z jej głównymi cechami: zero czasu, zero narzędzi i zero trudności.

hanging system / system podwieszany

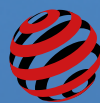

red dot winner 2022
furniture design



best of best



An ecological and sustainable system
Ekologiczny i zrównoważony system



patented, designed in
Italy and made in the
EU / opatentowany,
zaprojektowany
we Włoszech i
wyprodukowany w UE

**Zero vertical
Pionowy Zero**



Profile for Zero modular structures

Profil do tworzenia struktur modułowych Zero



Longitude/Długość	Finishing/Wykończenie	Packaging/Opakowanie	Cod.
2,35 m	Textured black painted/Teksturowana czerni	8 Unit/Szt	7020154
2,9 m	Textured black painted/Teksturowana czerni	8 Unit/Szt	7020254

Aluminium/Aluminium

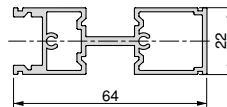

Hardware kit for mounting Zero profiles to the wall

Zestaw sprzętu do montażu profili Zero do ścian



Finishing/Wykończenie	Packaging/Opakowanie	Cod.
Textured black painted/Teksturowana czerni	4 Pair/Kpl.	7031954

Plastic, Zamak/Plastik, Znal

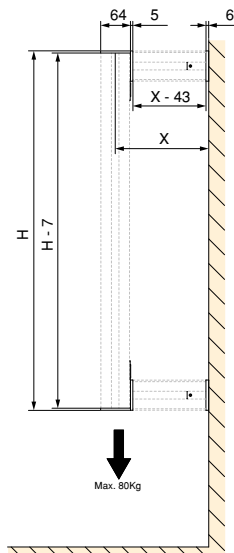
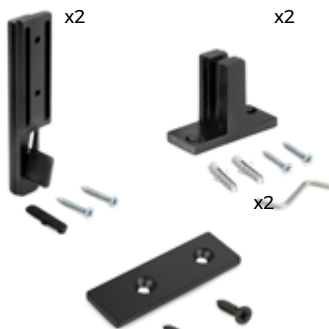

Tool assembly set for Zero rectangular leveller (Floor - Wall)
 Zestaw okuć do montażu profili Zero w kształcie litery (Podłoga - Ściana)



Finishing/Wykończenie	Packaging/Opakowanie	Cod.
Textured black painted/Teksturowana czerni 	8 Unit/Szt	7031054

Plastic, Zamak/Plastik, Znal

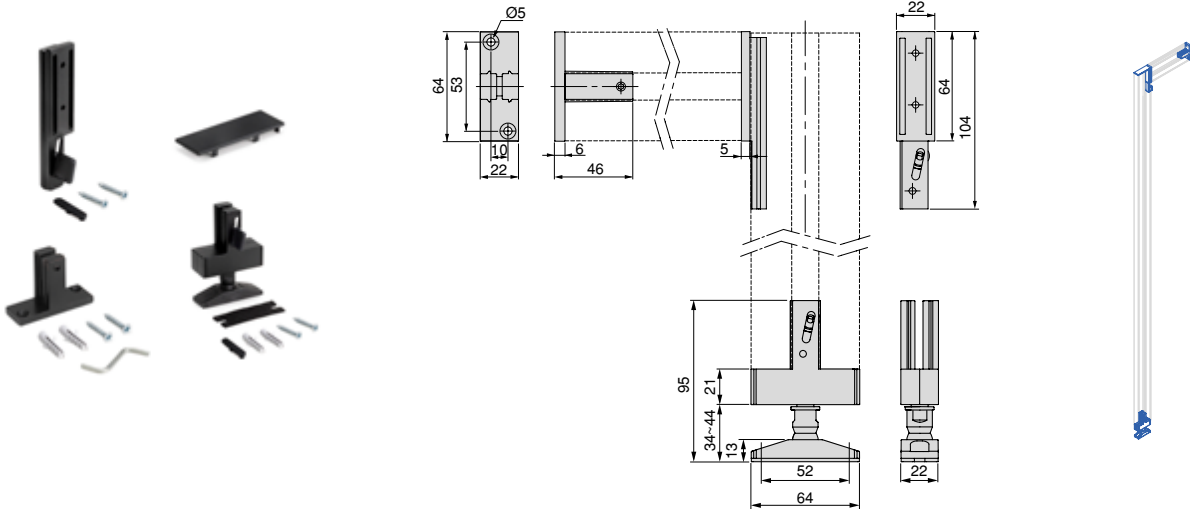

Set of rectangular levelers for mounting Zero profiles (Floor - Ceiling)
 Zestaw prostokątnych regulatorów wysokości do montażu profili Zero (Podłoga - Sufit)



Finishing/Wykończenie	Packaging/Opakowanie	Cod.
Textured black painted/Teksturowana czerni 	16 Unit/Szt	7031154

Plastic, Zamak/Plastik, Znal

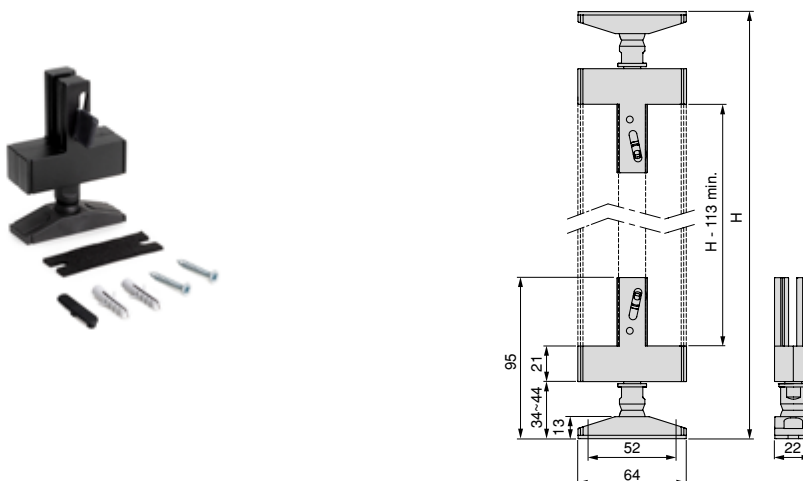

Set of circular levelers for mounting Zero profiles (Floor - Ceiling)

Zestaw niwelatorów okrągłych do montażu profili Zero (Podłoga - Sufit)

Finishing/Wykończenie	Packaging/Opakowanie	Cod.
Textured black painted/Teksturowana czerni 	16 Unit/Szt	7032754

Plastic, Zamak/Plastik, Znal

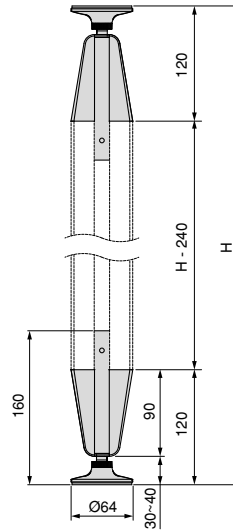

Piece to affix the Zero profile to the wall
Element do montażu ściennego profilu Zero



Finishing/Wykończenie	Packaging/Opakowanie	Cod.
Textured black painted/Teksturowana czerni 	8 Unit/Szt	7031754

Zamak/Znal

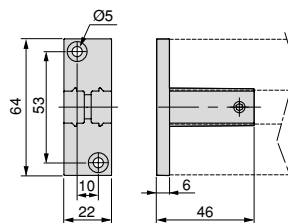

Joint between Zero profiles
Element do łączenia profili Zero



Finishing/Wykończenie	Packaging/Opakowanie	Cod.
Textured black painted/Teksturowana czerni 	8 Unit/Szt	7031254

Zamak/Znal

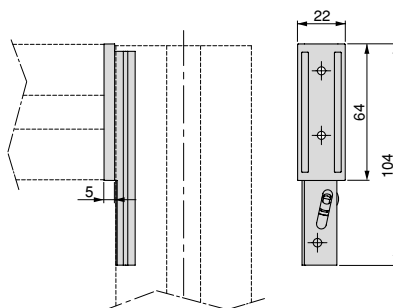

Cover cap for Zero profile
Zaślepka do profilu Zero

Finishing/Wykończenie	Packaging/Opakowanie	Cod.
Black plastic/Czarny plastik 	20 Unit/Szt	7032517

Plastic/Plastik

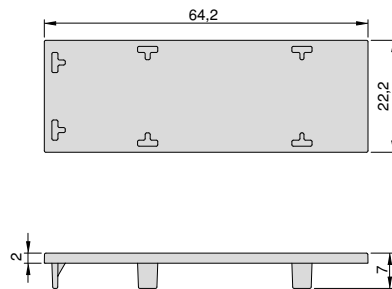

Tool for adjustment of Zero system accessories
Narzędzie do regulacji akcesoriów systemu Zero

Finishing/Wykończenie	Packaging/Opakowanie	Cod.
Black plastic/Czarny plastik 	8 Unit/Szt	7032617

Plastic, Steel/Plastik, Stal



Zero modular structure kit with tools and profiles to be assembled in the floor and the wall shape
 Zestaw struktury modułowej Zero z okuciami i profilami do montażu do podłogi oraz do ściany



Description/Opis	Finishing/Wykończenie	Packaging/Opakowanie	N° pieces/Liczba elementów	Cod.
2 Profiles/2 Profil	Textured black painted/Teksturowana czerni	1 KIT/Zestaw	2 UN/2 UN	7022054

Aluminium, Plastic, Zamak/Aluminium, Plastik, Znal

KITS

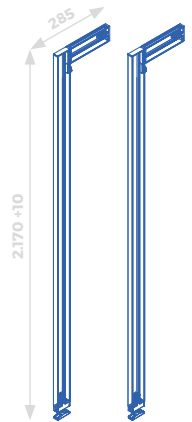
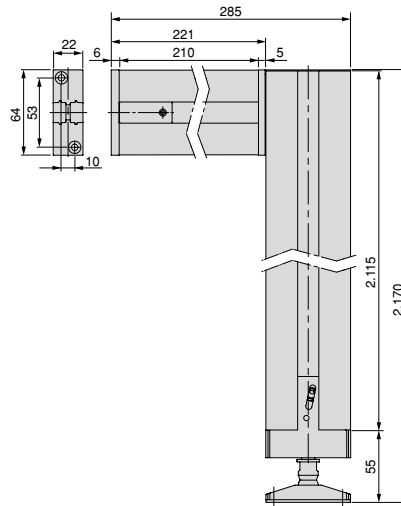
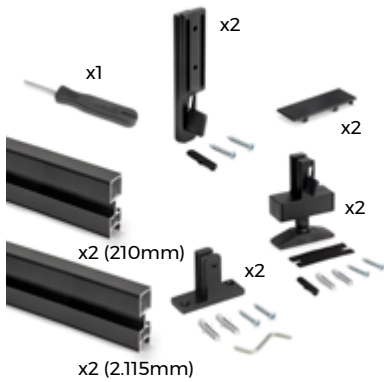

Zero modular structure kit with tools and profiles to be assembled in the floor and the wall shape
 Zestaw struktury modułowej Zero z okuciami i profilami do montażu do podłogi oraz do ściany



Description/Opis	Finishing/Wykończenie	Packaging/Opakowanie	N° pieces/Liczba elementów	Cod.
3 Profiles/3 Profil	Textured black painted/Teksturowana czerni	1 KIT/Zestaw	3 UN/3 UN	7022154

Aluminium, Plastic, Zamak/Aluminium, Plastik, Znal

KITS

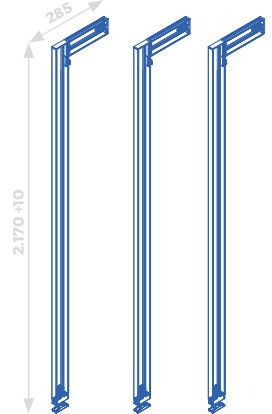
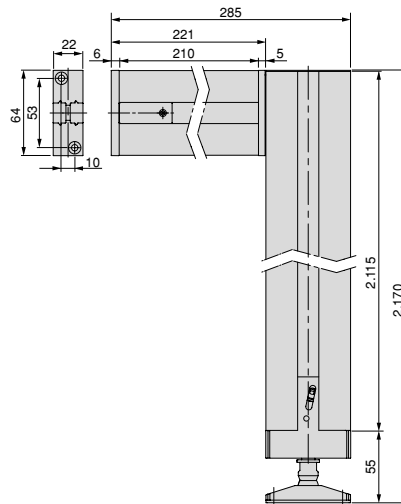
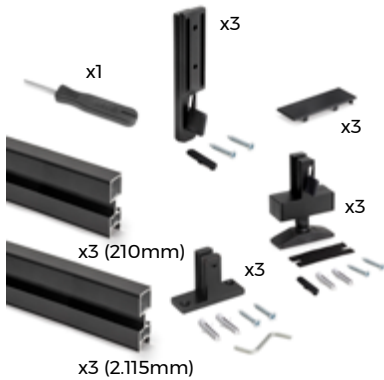

Zero modular structure kit with fittings and profiles for floor and ceiling mounting with rectangular leveller

Zestaw konstrukcji modułowej Zero z okuciami i profilami do montażu na podłodze i suficie z prostokątnym niwelatorem

Description/Opis	Finishing/Wykończenie	Packaging/Opakowanie	N° pieces/Liczba elementów	Cod.
2 Profiles/2 Profil	Textured black painted/Teksturowana czerni	1 KIT/Zestaw	2 UN/2 UN	7023354

Steel, Zamak/Stal, Znal

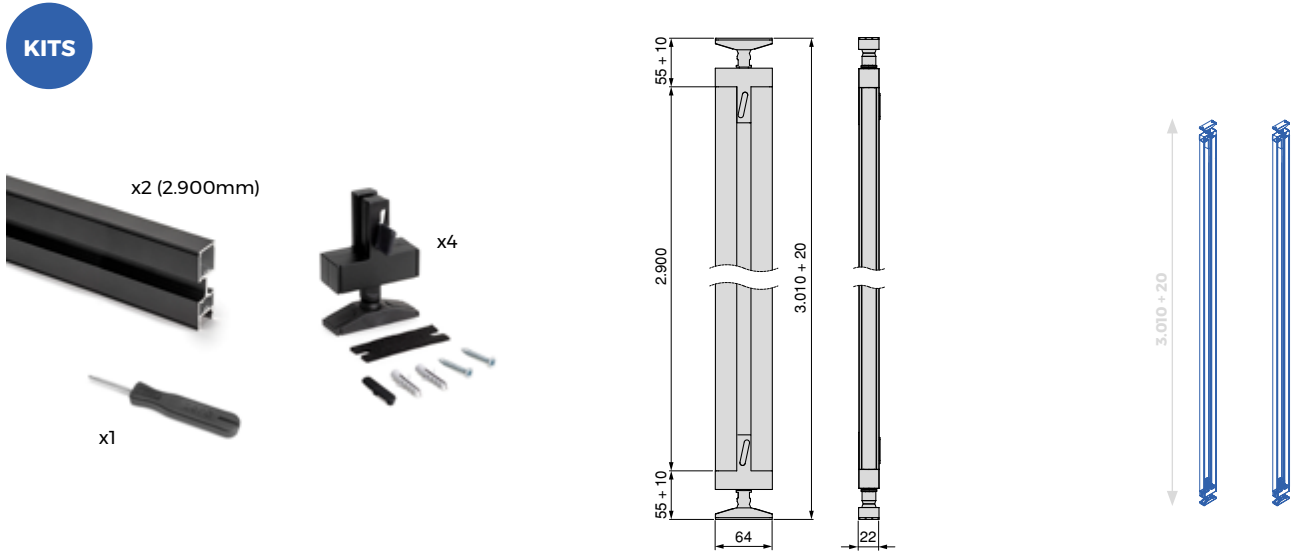

Zero modular structure kit with fittings and profiles for floor and ceiling mounting with rectangular leveller

Zestaw konstrukcji modułowej Zero z okuciami i profilami do montażu na podłodze i suficie z prostokątnym niwelatorem

Description/Opis	Finishing/Wykończenie	Packaging/Opakowanie	N° pieces/Liczba elementów	Cod.
3 Profiles/3 Profil	Textured black painted/Teksturowana czerni	1 KIT/Zestaw	3 UN/3 UN	7023854

Steel, Zamak/Stal, Znal

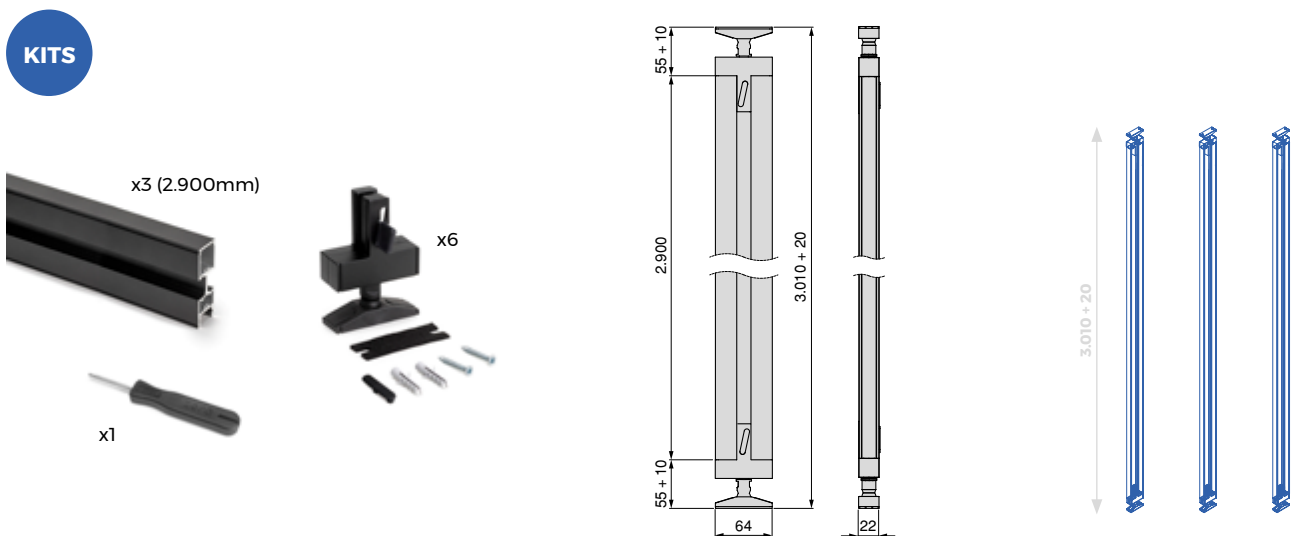

Zero Horizontal
Poziomy Zero



Zero modular structure kit with hardware for wall-mounted assembly
Zestaw konstrukcji modułowej Zero z okuciami do montażu na ścianie



Finishing/Wykończenie	Packaging/Opakowanie	Cod.
Textured black painted/Teksturowana czerni	1 KIT/Zestaw	7021854

Aluminium, Zamak/Aluminium, Znal

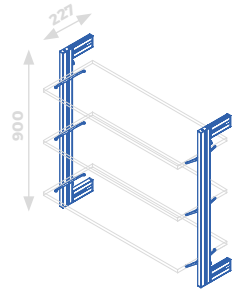
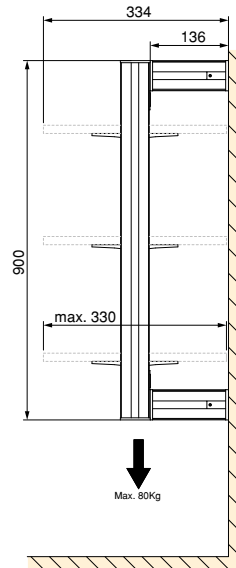

Zero support kit for wooden shelves and module
Zestaw wsporników Zero do półek drewnianych i modułów



Acabado/Acabamento	Packaging/Opakowanie	Cod.
Pintado negro texturizado/Preto texturado	1 KIT/Zestaw	7022254

Plastic, Zamak / Plastik, Znal

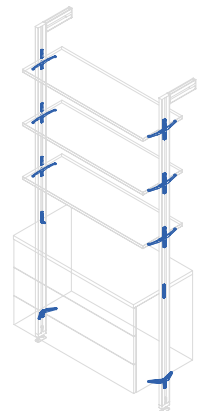

Zero Kit supports for wooden shelves and hanging rail

Zestaw wsporników Zero do półek z drewna i drążka do zawieszania



Finishing/Wykończenie	Packaging/Opakowanie	Cod.
Textured black painted/Teksturowana czerni	1 KIT/Zestaw	7022354

Aluminium, Plastic, Zamak/Aluminium, Plastik, Znal

KITS

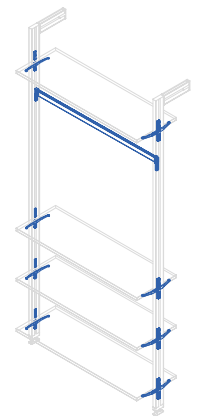

Zero support kit for wooden and module shelves and hanging rail

Zestaw wsporników Zero do półek z drewna, modułu i drążka na wieszaki



Finishing/Wykończenie	Packaging/Opakowanie	Cod.
Textured black painted/Teksturowana czerni	1 KIT/Zestaw	7022454

Aluminium, Plastic, Zamak/Aluminium, Plastik, Znal

KITS

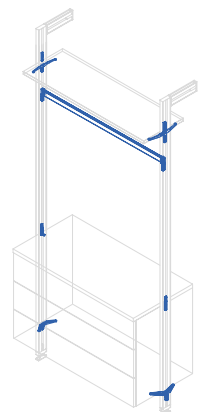

Zero support set for wooden shelf
Zestaw wsporników Zero do półki drewnianej



Finishing/Wykończenie	Packaging/Opakowanie	Cod.
Textured black painted/Teksturowana czerni	5 Unit/Szt	7031354

Zamak/Znal

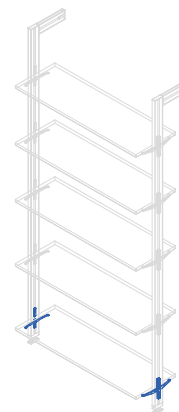
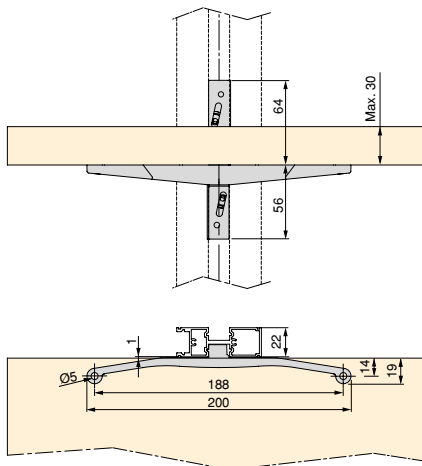

Zero support kit for module
Zestaw wsporników Zero do modułu 40



Finishing/Wykończenie	Packaging/Opakowanie	Cod.
Textured black painted/Teksturowana czerni	5 Unit/Szt	7031554

Zamak/Znal

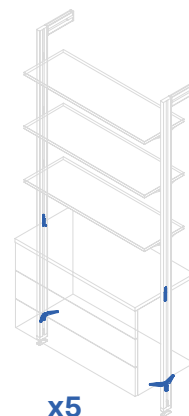
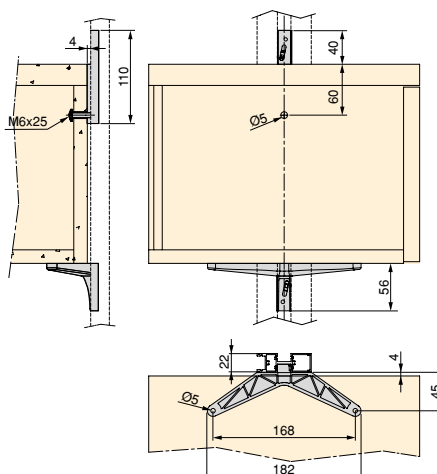

Zero support
Wsparcie Zero



Zero support set for glass shelf

Zestaw wsporników Zero do szklanej półki



Finishing/Wykończenie	Packaging/Opakowanie	Cod.
Textured black painted/Teksturowana czerni	5 Pair/Kpl.	7031454

Zamak/Znal

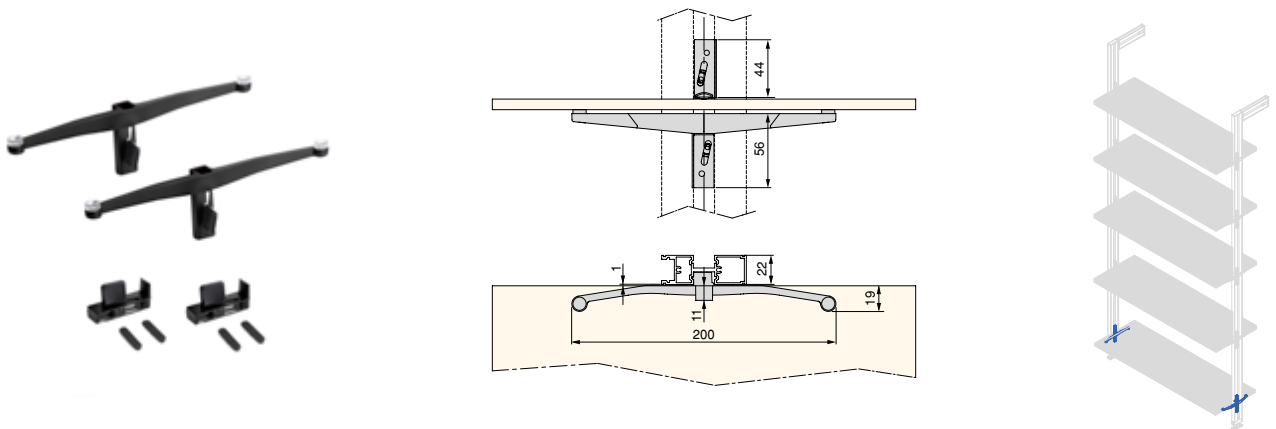

Set of brackets for an inclined wooden shelf for the Zero modular structure

Zestaw wsporników do pochylonej półki drewnianej do konstrukcji modułowej Zero

Finishing/Wykończenie	Packaging/Opakowanie	Cod.
Textured black painted/Teksturowana czerni	2 Pair/Kpl.	7033054

Steel, Zamak/Stal, Znal

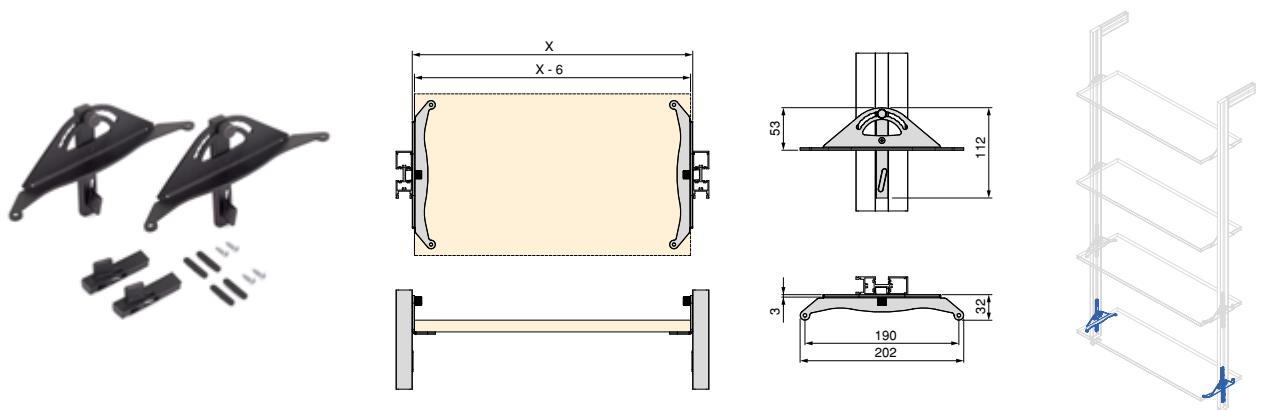

Zero aluminium shelves
Półki aluminiowe Zero

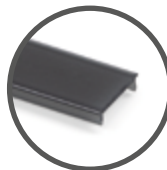
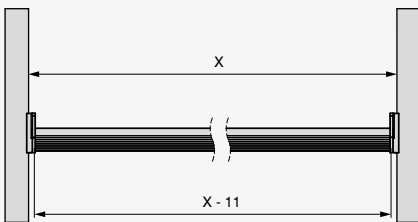
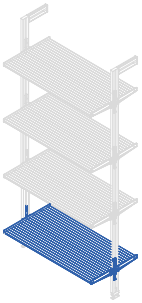

Hardware kit to make an aluminium shelf for the Zero modular structure
Zestaw sprzętu do wykonania półki aluminiowej do konstrukcji modułowej Zero

Finishing/Wykończenie	Packaging/Opakowanie	Cod.
Textured black painted/Teksturowana czerni 	1 Pair/Kpl.	7023254

Steel, Zamak/Stal, Znal

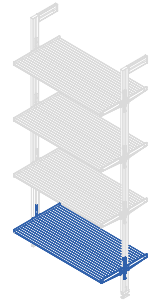
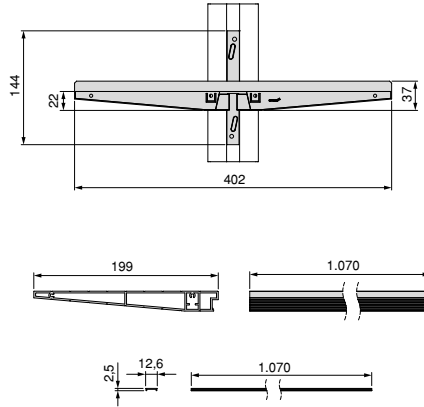
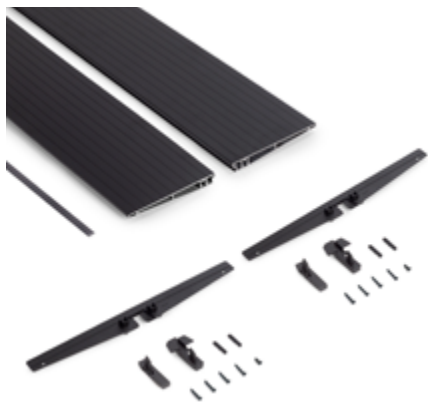

Set of brackets for mounting the aluminium shelf for the Zero modular structure
Zestaw wsporników do montażu półki aluminiowej do konstrukcji modułowej Zero

Finishing/Wykończenie	Packaging/Opakowanie	Cod.
Textured black painted/Teksturowana czerni 	2 Pair/Kpl.	7033154

Steel, Zamak/Stal, Znal

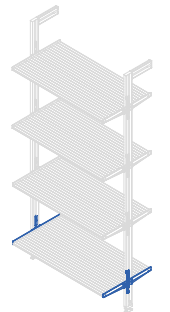

Profile to make aluminium shelves for the modular structure Zero
Profil do wykonania półek aluminiowych do konstrukcji modułowej Zero

Longitude/Długość	Finishing/Wykończenie	Packaging/Opakowanie	Cod.
2.160 mm	Textured black painted/Teksturowana czerni 	4 Unit/Szt	7020954

Aluminium/Aluminium

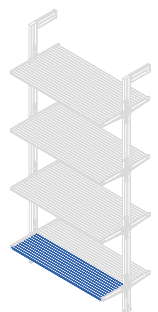
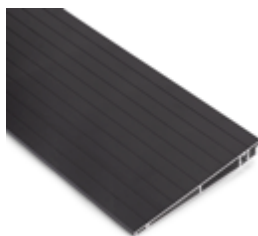

Luxe rectangular rail Drażek prostokątny Luxe

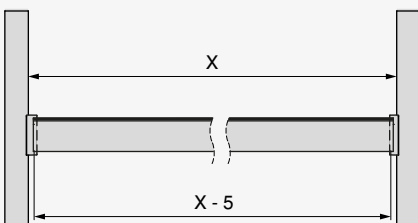
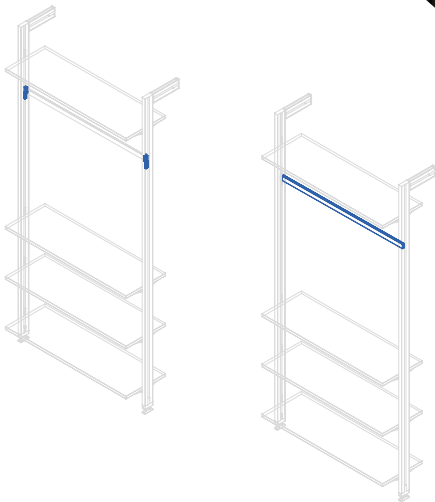

Zero support kit for hanging rail

Zestaw wsporników Zero do drążka na wieszaki



Finishing/Wykończenie	Packaging/Opakowanie	Cod.
Textured black painted/Teksturowana czerni	8 Pair/Kpl.	7031654

Plastic, Zamak/Plastik, Znal

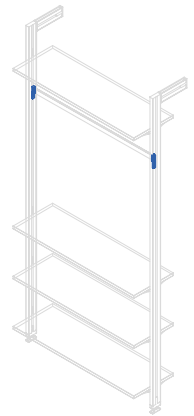
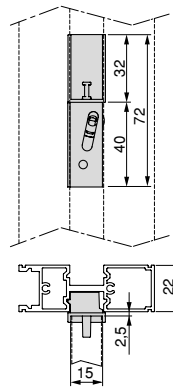

Luxe rectangular rail for Zero structure

Drążek prostokątny Luxe do struktury Zero



Longitude/Długość	Finishing/Wykończenie	Packaging/Opakowanie	Cod.
1 m	Textured black painted/Teksturowana czerni	10 Unit/Szt	7102154

Aluminium/Aluminium

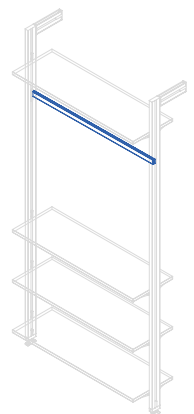
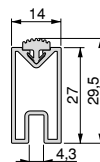
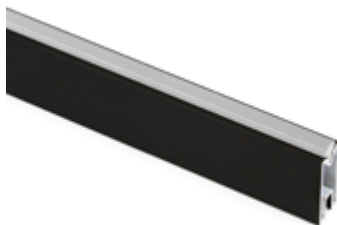

Hang and Hack accessories
Akcesoria Hang i Hack

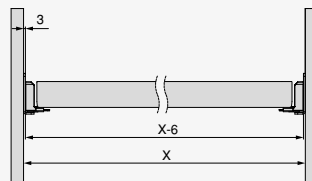
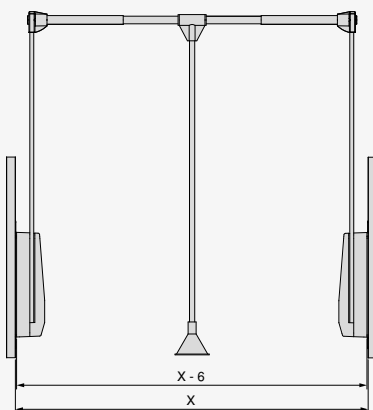
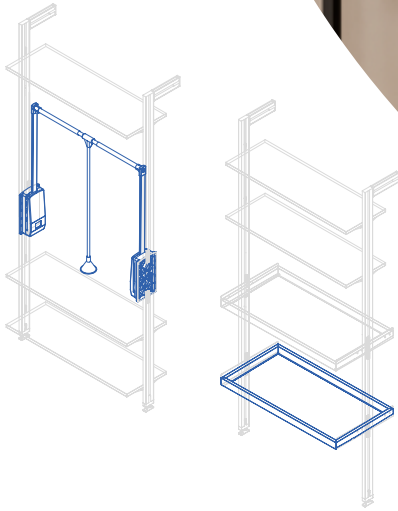

Set of fixings for the Hang folding hanger for the Zero modular structure
Zestaw mocowań do wieszaka składanego Hang do konstrukcji modułowej Zero

Finishing/Wykończenie	Packaging/Opakowanie	Cod.
Textured black painted/Teksturowana czerni 	1 Pair/Kpl.	7022854

Steel, Zamak/Stal, Znal

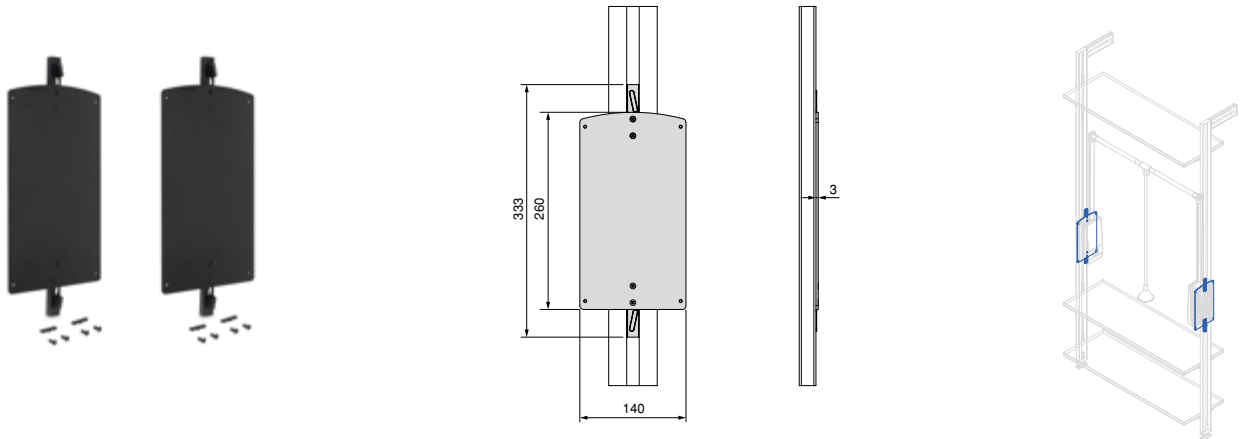

Fixing kit for the Hack cabinet racks for the Zero modular structure
Zestaw mocujący do stojaków szafy Hack dla konstrukcji modułowej Zero

Finishing/Wykończenie	Packaging/Opakowanie	Cod.
Textured black painted/Teksturowana czerni 	2 Pair/Kpl.	7032954

Steel, Zamak/Stal, Znal

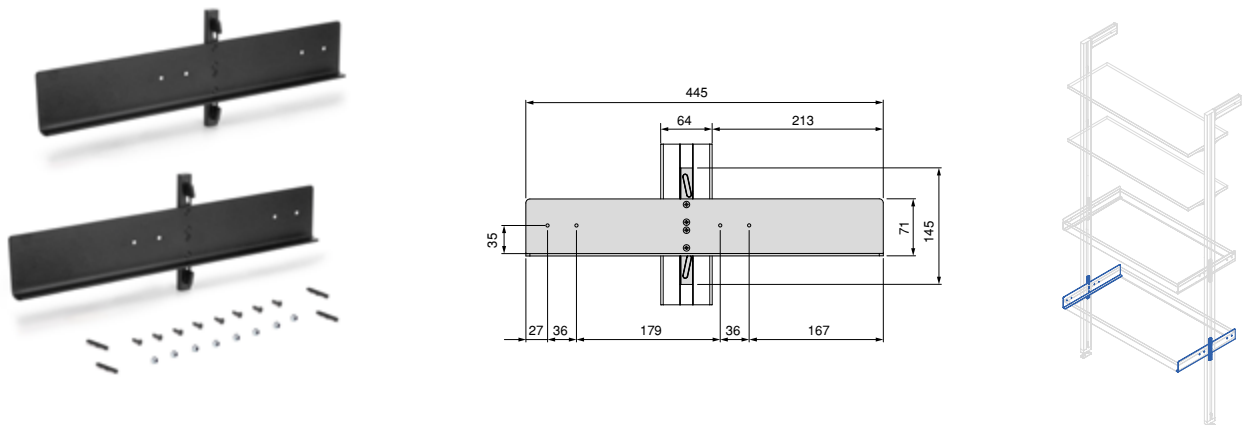

Pull down wardrobe rail lift
Wieszak składany

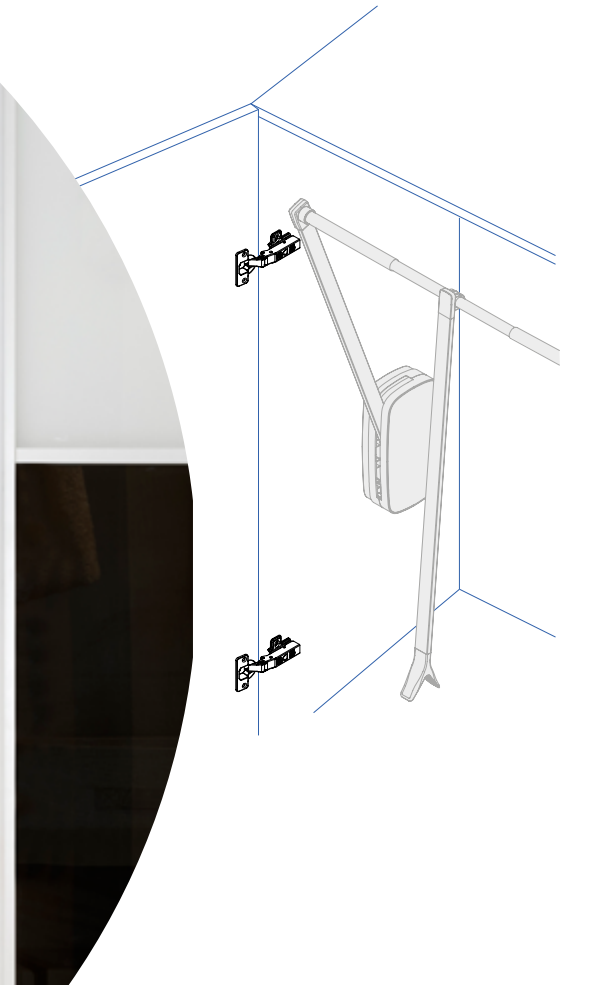
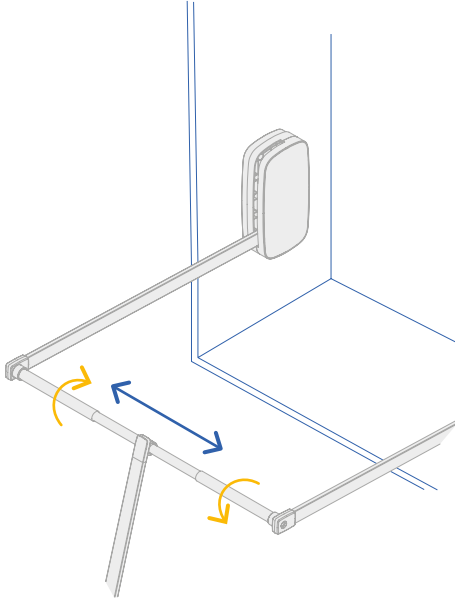

Sling pull down wardrobe rail lift
 Pantograf Sling



Width/Szerokość	Finishing/Wykończenie	Packaging/Opakowanie	Cod.
450 - 600	Titanium/Tytanowy	1 Unit/Szt	7030052
600 - 830	Titanium/Tytanowy	1 Unit/Szt	7030152
830 - 1150	Titanium/Tytanowy	1 Unit/Szt	7030252

Plastic, Steel/Plastik, Stal

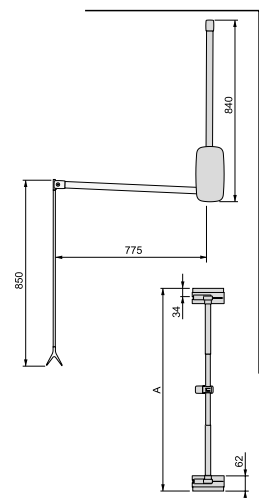
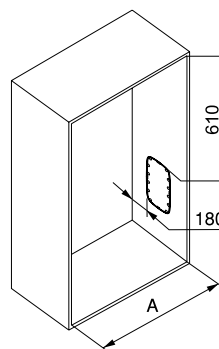

Side covers included to hide the installation screws.
 Also available are cover caps in textile effect.
 Includes mounting screws.
 The handle bar has a fixing system that reduces its swing-back.
 Central bar can be adjusted in width.
 Integrated opening bumper stop.

W komplecie boczne osłony maskujące wkręty montażowe.
 Dostępne są także osłony o powierzchni tekstylnej.
 W komplecie wkręty montażowe.
 Drążek uchwytu jest wyposażony w system mocujący, który ogranicza zakres odchylania się drążka po jego opuszczeniu.
 Szerokość drążka środkowego jest regulowana.
 Zintegrowany odbojnik w otworze na ramiona pantografu.

Set of dividers for Sling pull down wardrobe rail lift
 Zestaw przegródek do podnośnika szynowego do garderoby Sling

Finishing/Wykończenie	Packaging/Opakowanie	Cod.
Titanium plastic/Plastik tytanowy	6 Pair/Kpl.	7030438

Plastic/Plastik

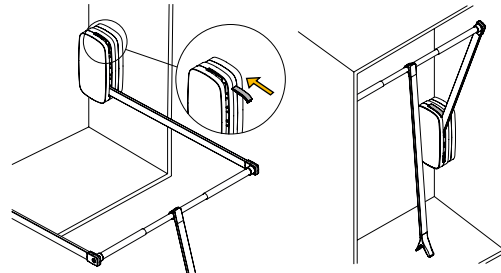

Allows Sling to be mounted to the back of the wardrobe.

Możliwość montowania drążka opuszczanego Sling do tylnej części szafy.

Suplemento lateral para colgador abatible para armario Sling
 Suplemento lateral para varão basculante Sling



Finishing/Wykończenie	Packaging/Opakowanie	Cod.
Titanium plastic/Plastik tytanowy	1 Pair/Kpl.	7067338

Plastic/Plastik

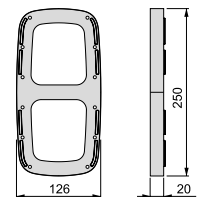
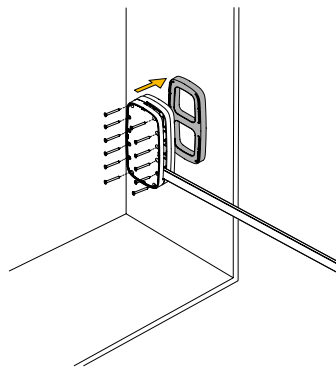

Hang pull down wardrobe rail lift
 Pantograf Hang



Width/Szerokość	Finishing/Wykończenie	Packaging/Opakowanie	Cod.
450 - 600	Black painted/Malowane na czarno	1 Unit/Szt	9283714
600 - 830	Black painted/Malowane na czarno	1 Unit/Szt	9283814
830 - 1150	Black painted/Malowane na czarno	1 Unit/Szt	9283914

Plastic, Steel/Plastik, Stal

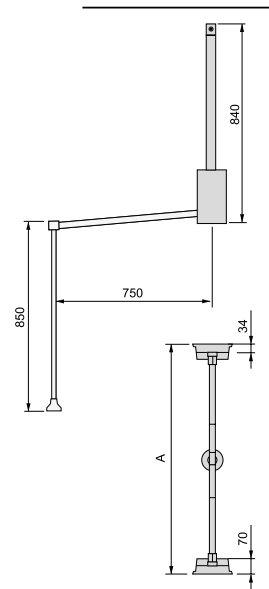
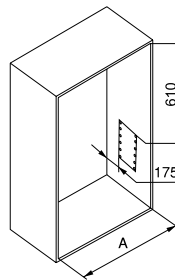

Side supplement for Hang pull down wardrobe rail lift
 Wkładka boczna do pantografu Hang

Finishing/Wykończenie	Packaging/Opakowanie	Cod.
Black plastic/Czarny plastik	1 Pair/Kpl.	7085017

Plastic/Plastik



x12

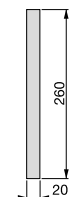

Wardrobe interior wardrobe rails
Drażki na wieszaki



Luxe rectangular wardrobe rail kit
Drażek kwadratowy do szafy Luxe

Longitude/Długość	Finishing/Wykończenie	Packaging/Opakowanie	Cod.
2.35 m	Textured black painted/Teksturowana czerní 	10 Unit/Szt	7100854

Aluminium/Aluminium

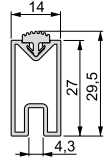
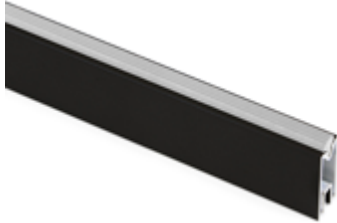

With semi-hard P.V.C profile to avoid coathanger noise and scratches.

Z półtwardym profilem P.V.C, aby uniknąć hałasu i zarysowań powłoki.

Silk wardrobe rail kit
Drażek do szafy Silk

Longitude/Długość	Finishing/Wykończenie	Packaging/Opakowanie	Cod.
2.35 m	Black painted/Malowane na czarno 	10 Unit/Szt	6072114

Aluminium/Aluminium

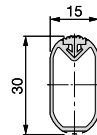

With semi-hard P.V.C profile to avoid coathanger noise and scratches.

Z półtwardym profilem P.V.C, aby uniknąć hałasu i zarysowań powłoki.



Ø28 round wardrobe rail
Okrągły drażek do szafy Ø28

Longitude/Długość	Finishing/Wykończenie	Packaging/Opakowanie	Cod.
2.35 m	Black painted/Malowane na czarno 	10 Unit/Szt	6057814

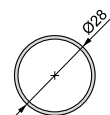
Aluminium/Aluminium



Wardrobe hanging rail kit Luxe
Zestaw drążków Luxe

Longitude/Długość	Finishing/Wykończenie	Packaging/Opakowanie	Cod.
1,15 m	Textured black painted/Teksturowana czerń 	1 KIT/Zestaw	7101354
0,75 m	Textured black painted/Teksturowana czerń 	1 KIT/Zestaw	7101454

Aluminium, Plastic/Aluminium, Plastik

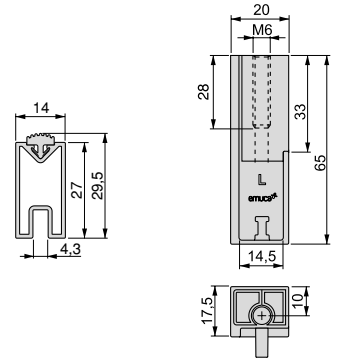

The kit includes everything needed to mount two wardrobe bars Luxe: the tube, the lateral supports, the assembly M6 screws.

The tube has a piece of PVC rubber co-extruded in order to avoid noise when moving the hangers.

The 1150 mm kits also include 2 central supports to provide the assembly with greater rigidity.

Zestaw zawiera wszystko, co jest potrzebne do montażu dwóch prętów do szafy Luxe: rurki, wsporniki boczne i śruby M6 do montażu.

Rurka posiada współwytłaczaną gumę z PVC, aby wytłumić hałas wieszaków.

Zestawy 1150mm posiadają również 2 wsporniki centralne, aby zapewnić większą sztywność montażu.



Wardrobe hanging rail kit Silk
Zestaw drążków Silk

Longitude/Długość	Finishing/Wykończenie		Packaging/Opakowanie	Cod.
1,15 m	Black painted/Malowane na czarno	■	1 KIT/Zestaw	7070014
0,75 m	Black painted/Malowane na czarno	■	1 KIT/Zestaw	7070114

Aluminium, Plastic/Aluminium, Plastik



KITS

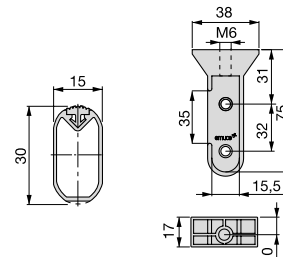

The kit includes everything needed to mount two 30x15 mm wardrobe bars Silk: the tube, the lateral supports, the assembly M6 screws.

The tube has a piece of PVC rubber co-extruded in order to avoid noise when moving the hangers.

The 1150 mm kits also include 2 central supports to provide the assembly with greater rigidity.

Zestaw zawiera wszystko, co jest potrzebne do montażu dwóch prętów do szafy Silk 30x15 mm: rurki, wsporniki boczne i śruby M6 do montażu.

Rurka posiada współwytłaczaną gumę z PVC, aby wytłumić hałas wieszaków.

Zestawy 1150mm posiadają również 2 wsporniki centralne, aby zapewnić większą sztywność montażu.

Wardrobe hanging rail kit round Ø28
Zestaw drążków okrągłych średnica Ø28

Longitude/Długość	Finishing/Wykończenie		Packaging/Opakowanie	Cod.
0,75 m	Black painted/Malowane na czarno	■	1 KIT/Zestaw	7070714
1,15 m	Black painted/Malowane na czarno	■	1 KIT/Zestaw	7070614

Aluminio, Zamak/Aluminio, Zamak



KITS

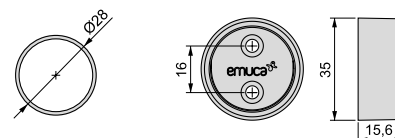

The kit includes everything needed to mount two D.28 mm wardrobe bars: the tube, the lateral supports, the assembly screws.

The 1150 mm kits also include 2 central supports to provide the assembly with greater rigidity.

Zestaw zawiera wszystko, co jest potrzebne do montażu dwóch prętów do szafy o średnicy 28 mm: rurkę, wsporniki boczne i śruby do montażu.

Zestawy 1150 mm zawierają również 2 wsporniki centralne, aby zapewnić większą sztywność montażu.



Luxe wardrobe rail support set
Zestaw uchwytów do szafy Luxe

Finishing/Wykończenie	Packaging/Opakowanie	Cod.
Textured black painted/Teksturowana czerni 	10 Pair/Kpl.	7102054

Zamak/Znal



To calculate the measurement of the bar, subtract 10 mm from the inter-axis of the end support.

W celu obliczenia wymiaru drążka, od rozstawu osi wspornika należy odjąć 10 mm.

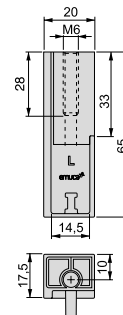

Luxe wardrobe rail central support
Środkowy uchwyt drążka do szafy Luxe

Finishing/Wykończenie	Packaging/Opakowanie	Cod.
Textured black painted/Teksturowana czerni 	20 Unit/Szt	7100354

Zamak/Znal

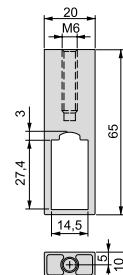

Luxe wardrobe rail angular support
Uchwyt kątowy drążka do szafy

Finishing/Wykończenie	Packaging/Opakowanie	Cod.
Textured black painted/Teksturowana czerni 	20 Unit/Szt	7100254

Zamak/Znal

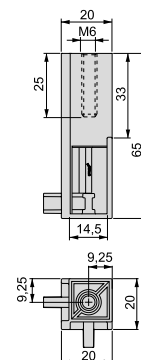

Luxe wardrobe rail support
Uchwyt do drążka do szafy Luxe



Finishing/Wykończenie	Packaging/Opakowanie	Cod.
Textured black painted/Teksturowana czerni	20 Pair/Kpl.	7101554

Plastic/Plastik



To calculate the measurement of the rail subtract 11 mm from the internal width.
Aby obliczyć wymiar szyny, od wewnętrznej szerokości należy odjąć 11 mm.

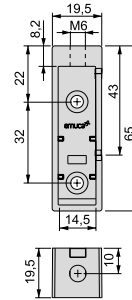

Ø28 wardrobe rail support set
Zestaw uchwytów do drążka do szafy Ø28

Finishing/Wykończenie	Packaging/Opakowanie	Cod.
Black painted/Malowane na czarno	10 Pair/Kpl.	7922514

Zamak/Znal



To calculate the measurement of the bar, subtract 3 mm from the inter-axis of the end support.
W celu obliczenia wymiaru drążka, od rozstawu osi wspornika należy odjąć 3 mm.

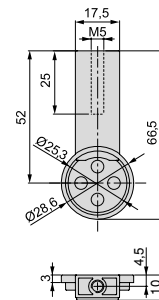

Ø28 wardrobe rail central support
Środkowy uchwyt drążka do szafy Ø28

Finishing/Wykończenie	Packaging/Opakowanie	Cod.
Black painted/Malowane na czarno	20 Unit/Szt	7919714

Zamak/Znal

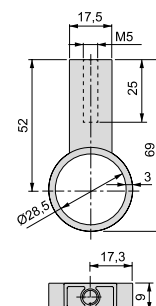

Ø28 wardrobe rail lateral support
Boczny uchwyt drążka do szafy Ø28

Finishing/Wykończenie	Packaging/Opakowanie	Cod.
Black plastic/Czarny plastik	50 Unit/Szt	7919817

Plastic, Zamak/Plastik, Znal



To calculate the measurement of the rail subtract 6 mm from the internal width.

W celu obliczenia wymiaru drążka, należy odjąć 6 mm od i wyposażonej szerokości.

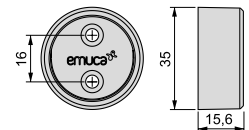

Silk wardrobe rail central support
Środkowy uchwyt drążka do szafy Silk

Finishing/Wykończenie	Packaging/Opakowanie	Cod.
Black painted/Malowane na czarno	20 Unit/Szt	6003114

Plastic/Plastik

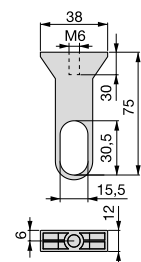

Silk wardrobe rail support set
Zestaw uchwytów do drążka do szafy Silk

Finishing/Wykończenie	Packaging/Opakowanie	Cod.
Black painted/Malowane na czarno	10 Pair/Kpl.	7101014

Plastic/Plastik



To calculate the measurement of the rail subtract 7 mm from the internal width.

W celu obliczenia wymiaru drążka, należy odjąć 7 mm od i wyposażonej szerokości.

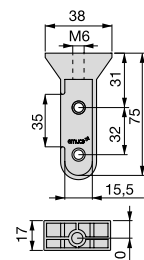

Silk wardrobe rail angular support
Uchwyt kątowy drążka do szafy Silk

Finishing/Wykończenie	Packaging/Opakowanie	Cod.
Black painted/Malowane na czarno 	20 Unit/Szt	6003214

Plastic/Plastik

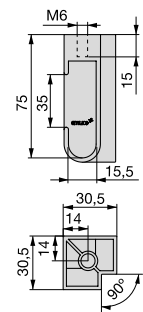

Wall coat racks
Wieszak ścienny



Wellington wall hanger
Wieszak ścienny Wellington

Finishing/Wykończenie	Packaging/Opakowanie	N° pieces/Liczba elementów	Cod.
Black painted/Malowane na czarno	1 Unit/Szt	7 units/7 jednostki	7200214

Zamak/Znal

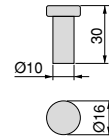

Hamilton wall hanger
Wieszak ścienny Hamilton

Finishing/Wykończenie	Packaging/Opakowanie	Cod.
Black painted/Malowane na czarno	1 Unit/Szt	7200314

Steel/Stal

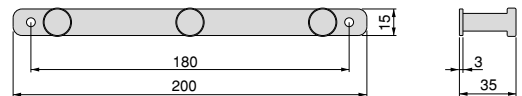

Nelson wall hanger
Wieszak ścienny Nelson

Finishing/Wykończenie	Packaging/Opakowanie	N° pieces/Liczba elementów	Cod.
Black painted/Malowane na czarno	1 LOT/Partia	4 units/4 jednostki	7200114

Aluminium/Aluminium

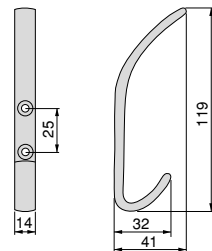

Folding wall hanger
Składany wieszak ścienny

Finishing/Wykończenie	Packaging/Opakowanie	N° pieces/Liczba elementów	Cod.
Black painted/Malowane na czarno	1 Unit/Szt	5 units/5 jednostki	7200414

Steel/Stal

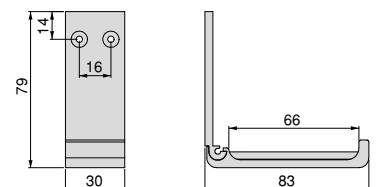

Hack accessories
Akcesoria Hack

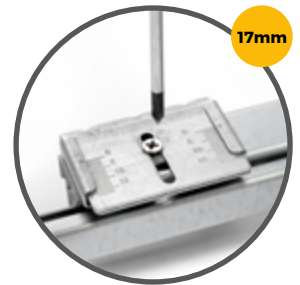

Frame with soft-close slides for cabinet accessories Hack
 Rama z szynami z systemem Soft-Close dla akcesoriów szafek Hack

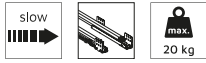

A	B	Finishing/Wykończenie	Packaging/Opakowanie	Cod.
560 - 594	483 (M60)	Textured black painted/Teksturovana czerń	2 Unit/Szt	7113054
623 - 657	546	Textured black painted/Teksturovana czerń	2 Unit/Szt	7113154
682 - 716	605	Textured black painted/Teksturovana czerń	2 Unit/Szt	7113254
741 - 775	664	Textured black painted/Teksturovana czerń	2 Unit/Szt	7113354
760 - 794	683 (M80)	Textured black painted/Teksturovana czerń	2 Unit/Szt	7113454
798 - 832	721	Textured black painted/Teksturovana czerń	2 Unit/Szt	7113554
832 - 866	755	Textured black painted/Teksturovana czerń	2 Unit/Szt	7113654
860 - 894	783 (M90)	Textured black painted/Teksturovana czerń	2 Unit/Szt	7113754
923 - 957	846	Textured black painted/Teksturovana czerń	2 Unit/Szt	7113854
982 - 1.016	905	Textured black painted/Teksturovana czerń	2 Unit/Szt	7113954
1.041 - 1.075	964	Textured black painted/Teksturovana czerń	2 Unit/Szt	7114054

Aluminium, Plastic/Aluminium, Plastik

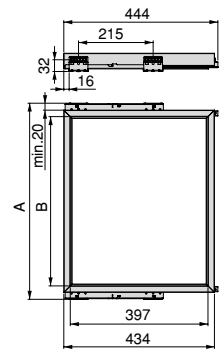
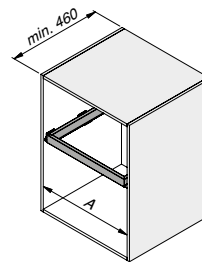

Drawer or wire basket for closets and dressers Hack
 Szuflada lub kosz druciany do szafy Hack i komody

B	Finishing/Wykończenie		Packaging/Opakowanie	Cod.
482 (M60)	Textured black painted/Teksturowana czerń		2 Unit/Szt	7114754
682 (M80)	Textured black painted/Teksturowana czerń		2 Unit/Szt	7114854
782 (M90)	Textured black painted/Teksturowana czerń		2 Unit/Szt	7114954

Steel/Stal

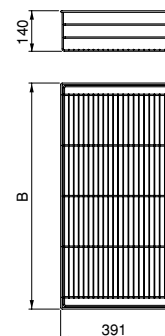
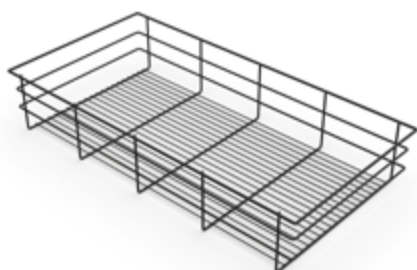

Shoe drawer for closets and dressers Hack
 Szuflada na buty do szafy i garderoby Hack

B	Finishing/Wykończenie		Packaging/Opakowanie	Cod.
482 (M60)	Textured black painted/Teksturowana czerń		2 Unit/Szt	7114454
682 (M80)	Textured black painted/Teksturowana czerń		2 Unit/Szt	7114554
782 (M90)	Textured black painted/Teksturowana czerń		2 Unit/Szt	7114654

Steel/Stal

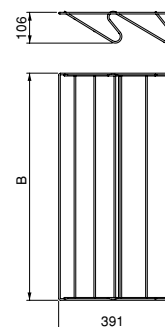
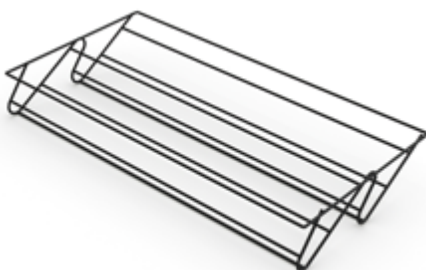

Tray or shelf for closets and dressers Hack

Taca lub półka do szaf i garderoby Hack

B	Finishing/Wykończenie		Packaging/Opakowanie	Cod.
483 (M60)	Textured black painted/Teksturowana czerni		2 Unit/Szt	7115154
683 (M80)	Textured black painted/Teksturowana czerni		2 Unit/Szt	7115254
783 (M90)	Textured black painted/Teksturowana czerni		2 Unit/Szt	7115354

Steel/Stal

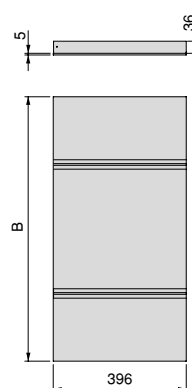
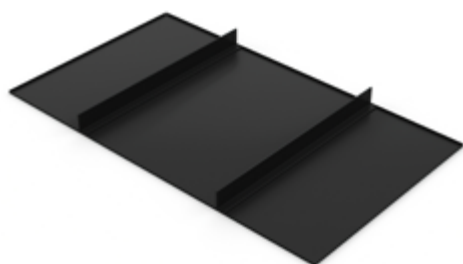

Organizer drawer for closets and dressers Hack

Szuflada organizacyjna do szafy i garderoby Hack

B	Finishing/Wykończenie		Packaging/Opakowanie	Cod.
483 (M60)	Painted stone grey/Malowany na kolor kamienno-szary		1 Unit/Szt	711149
683 (M80)	Painted stone grey/Malowany na kolor kamienno-szary		1 Unit/Szt	7111249
783 (M90)	Painted stone grey/Malowany na kolor kamienno-szary		1 Unit/Szt	7111349

Wood/Drewno

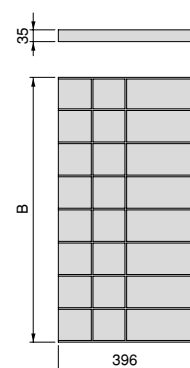

Side spacer for Hack frame
 Boczny element dystansowy do ramy Hack

Finishing/Wykończenie	Packaging/Opakowanie	Cod.
Black plastic/Czarny plastik 	4 Unit/Szt	7115417

Plastic/Plastik

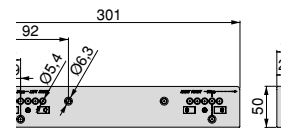

A spacer is required on the side of the cabinet where it coincides with the door and is installed in the place where the guide goes. Its function is to leave a space of 25mm between the frame and the side of the cabinet so that the door does not collide with the frame.
 You can first install the spacer to the cabinet with $\varnothing 4 \times 25$ mm screws and then attach the slide with EURO $\varnothing 6,2 \times 13$ mm screws. Or you can pre-mount the spacer to the rail with the built-in clips, and then attach the assembly to the cabinet with $\varnothing 4 \times 40$ mm screws.

Po stronie szafki w miejscu, w którym styka się ona z drzwiami, wymagany jest element dystansowy, który montuje się w miejscu, w którym przebiega prowadnica. Jego zadaniem jest pozostawienie 25 mm wolnej przestrzeni pomiędzy ramą a bokiem korpusu, tak aby drzwi nie kolidowały z ramą. Podkładkę dystansową można najpierw przymocować do korpusu za pomocą wkrętów $\varnothing 4 \times 25$ mm, a następnie zamocować szynę za pomocą wkrętów EURO $\varnothing 6,2 \times 13$ mm. Można też zamocować tuleję dystansową do szyny za pomocą klipsów, a następnie przymocować ją do obudowy za pomocą śrub $\varnothing 4 \times 40$ mm.

Set of 7 trouser rods for closets and dressing rooms Hack
 Zestaw 7 drążków na spodnie do szafy Hack i garderoby

N° pieces/Liczba elementów	Finishing/Wykończenie	Packaging/Opakowanie	Cod.
7 units/7 jednostki	Textured black painted/Teksturowana czernią 	1 LOT/Partia	7112054

Aluminium, Plastic/Aluminium, Plastik

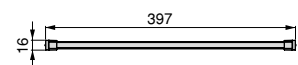

Closet and dressing room organizer basket Hack
 Kosz organizacyjny do szafy i garderoby Hack

Finishing/Wykończenie	Packaging/Opakowanie	Cod.
Grey textil effect/Efekt szarej tkaniny 	6 Unit/Szt	7115827

Fabric/Tkanina

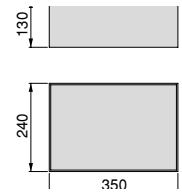

Auxiliary tray for closets and dressing rooms Hack
 Taca pomocnicza do szafy Hack i garderoby

Finishing/Wykończenie	Packaging/Opakowanie	Cod.
Not defined/Nieokreślone 	2 Unit/Szt	7115920

Plastic/Plastik

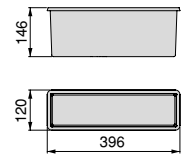

Hack compositions Hack kompozycje

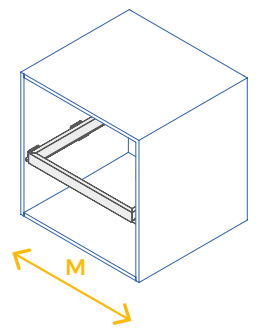
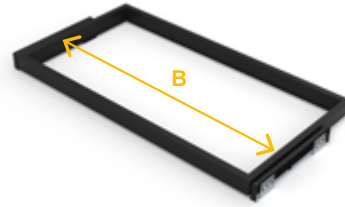

KITS



7113054 + 7111149
B = 483 (M60)

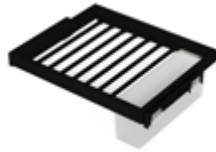

7113154 + 7112054 + 7115920
B = 546

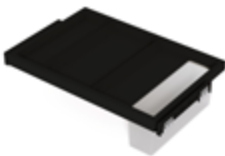

7113254 + 7115154 + 7115920
B = 605



7113354 + 7114754 + 7112054
B = 664



7113454 + 7114554
B = 683 (M80)

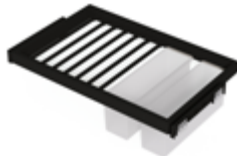

7113554 + 7112054 + 7115920
B = 721

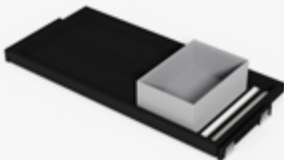

7113654 + 7115354 + 7112054 + 7115827
B = 755

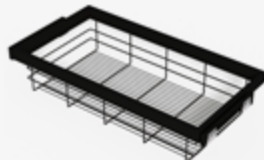

7113754 + 7114954
B = 783 (M90)

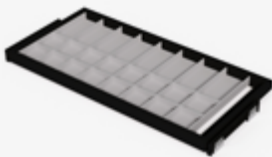

7113854 + 711349 + 7112054
B = 846

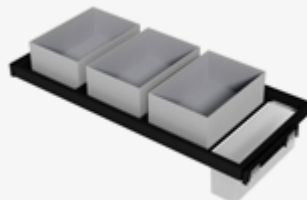

7113954 + 7115354 + 7115920 + 7115827
B = 905

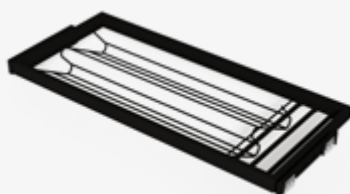

7114054 + 7114654 + 7112054
B = 964



7028354
B = 483 (M60)



7028454
B = 683 (M80)



7028554
B = 783 (M90)

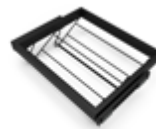

7028054
B = 483 (M60)

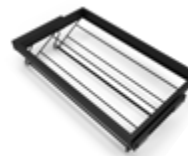

7028154
B = 683 (M80)

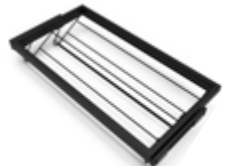

7028254
B = 783 (M90)

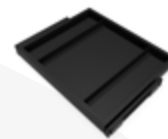

7028954
B = 483 (M60)



7029054
B = 683 (M80)

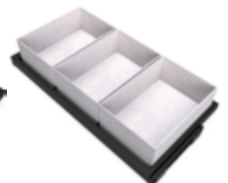

7029154
B = 783 (M90)

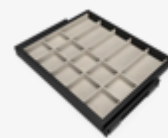

7028654
B = 483 (M60)



7028754
B = 683 (M80)

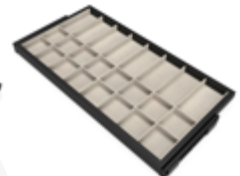

7028854
B = 783 (M90)



7029254
B = 483 (M60)

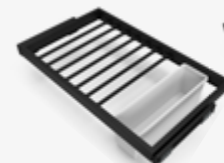

7029354
B = 683 (M80)

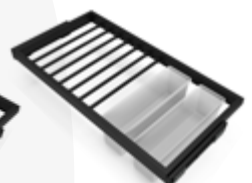

7029454
B = 783 (M90)

Hack pull out wire drawer kit for wardrobes
 Zestaw koszy drucianych Hack do szaf

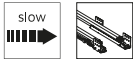

A	B	Finishing/Wykończenie	Packaging/Opakowanie	Cod.
560 - 594	483 (M60)	Textured black painted/Teksturovana czerni	1 KIT/Zestaw	7028354
760 - 794	683 (M80)	Textured black painted/Teksturovana czerni	1 KIT/Zestaw	7028454
860 - 894	783 (M90)	Textured black painted/Teksturovana czerni	1 KIT/Zestaw	7028554

Aluminium, Plastic, Steel/Aluminium, Plastik, Stal

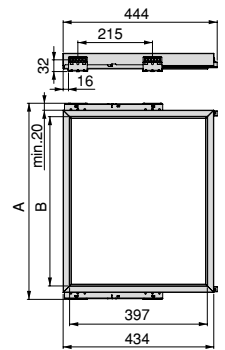
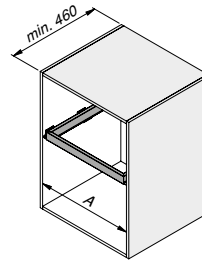

Hack Wire shoe rack kit for wardrobes
 Zestaw drucianych półek na buty Hack do szaf

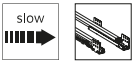

A	B	Finishing/Wykończenie	Packaging/Opakowanie	Cod.
560 - 594	483 (M60)	Textured black painted/Teksturovana czerni	1 KIT/Zestaw	7028054
760 - 794	683 (M80)	Textured black painted/Teksturovana czerni	1 KIT/Zestaw	7028154
860 - 894	783 (M90)	Textured black painted/Teksturovana czerni	1 KIT/Zestaw	7028254

Aluminium, Plastic, Steel/Aluminium, Plastik, Stal

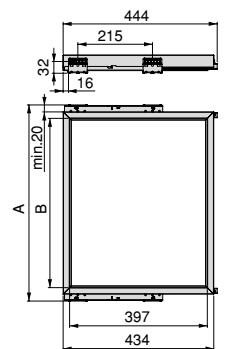
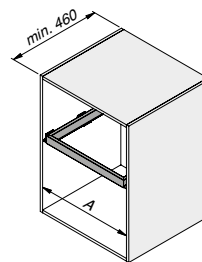

Hack Kit of tray and rack with slides for wardrobe

Kit taca lub półka do szaf i garderoby Hack

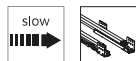

A	B	Finishing/Wykończenie	Packaging/Opakowanie	Cod.
560 - 594	483 (M60)	Textured black painted/Teksturovana czerni	1 KIT/Zestaw	7028954
760 - 794	683 (M80)	Textured black painted/Teksturovana czerni	1 KIT/Zestaw	7029054
860 - 894	783 (M90)	Textured black painted/Teksturovana czerni	1 KIT/Zestaw	7029154

Aluminium, Fabric, Plastic, Steel/Aluminium, Plastik, Stal, Tkanina

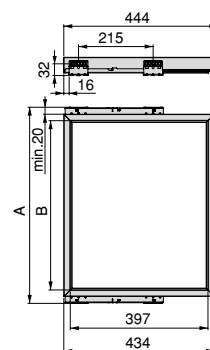
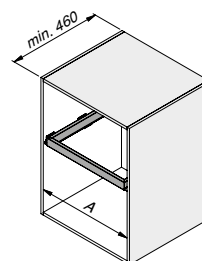

Kit organizer drawer Hack for wardrobes

Zestaw szuflada z przegródkami Hack do szafy

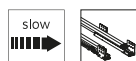

A	B	Finishing/Wykończenie	Packaging/Opakowanie	Cod.
560 - 594	483 (M60)	Textured black painted/Teksturovana czerni	1 KIT/Zestaw	7028654
760 - 794	683 (M80)	Textured black painted/Teksturovana czerni	1 KIT/Zestaw	7028754
860 - 894	783 (M90)	Textured black painted/Teksturovana czerni	1 KIT/Zestaw	7028854

Aluminium, Plastic, Wood/Aluminium, Drewno, Plastik

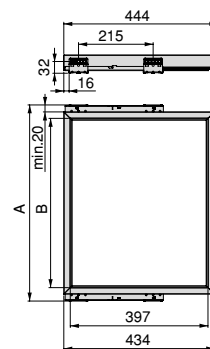
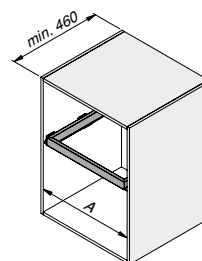

Trouser rod kit Hack for wardrobes
 Zestaw na spodnie Hack do szafy

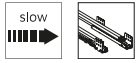

A	B	Finishing/Wykończenie	Packaging/Opakowanie	Cod.
560 - 594	483 (M60)	Textured black painted/Teksturowana czerni	1 KIT/Zestaw	7029254
760 - 794	683 (M80)	Textured black painted/Teksturowana czerni	1 KIT/Zestaw	7029354
860 - 894	783 (M90)	Textured black painted/Teksturowana czerni	1 KIT/Zestaw	7029454

Aluminium, Plastic/Aluminium, Plastik

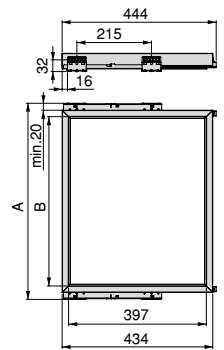
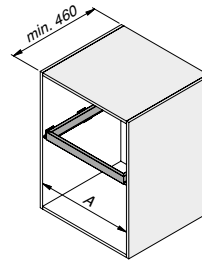

Pull-out side shoe rack for closets and walk-in closets Hack
 Wysuwana półka na buty do szafy typu Hack i garderoby typu walk-in

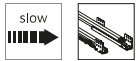

Hand/Uchwyty	Finishing/Wykończenie	Packaging/Opakowanie	Cod.
Right/Prawy	Textured black painted/Teksturowana czerni	1 Unit/Szt	7112654
Left/Lewy	Textured black painted/Teksturowana czerni	1 Unit/Szt	7112754

Steel/Stal



Left/Lewy Right/Prawy

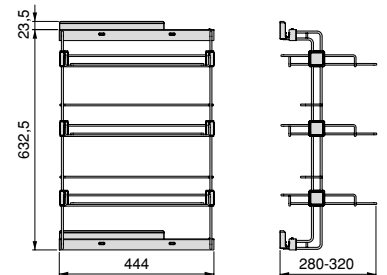
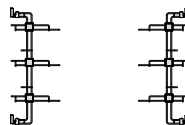

Pull-out trouser rack
 Wysuwany wieszak na spodnie



Finishing/Wykończenie	Packaging/Opakowanie	Cod.
Black painted/Malowane na czarno	1 Unit/Szt	7017814

Steel/Stal

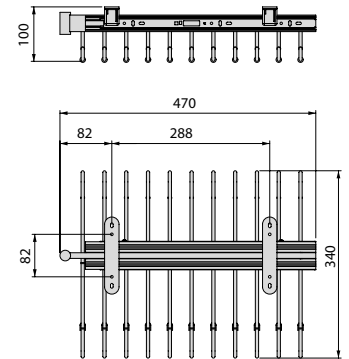
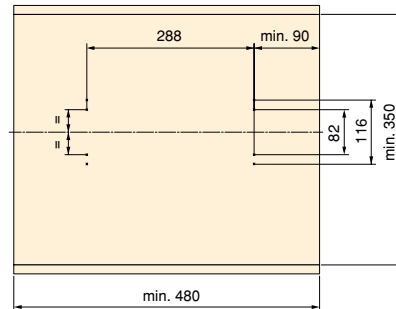

Pull-out mirror for inside wardrobe
 Wysuwane lustro do szafy



Finishing/Wykończenie	Packaging/Opakowanie	Cod.
Textured black painted/Teksturowana czern	1 Unit/Szt	7018054

Glass, Plastic, Steel/Plastik, Stal, Szkło

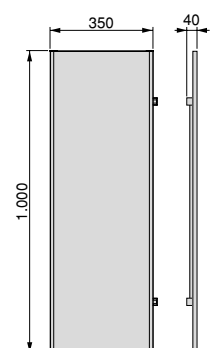
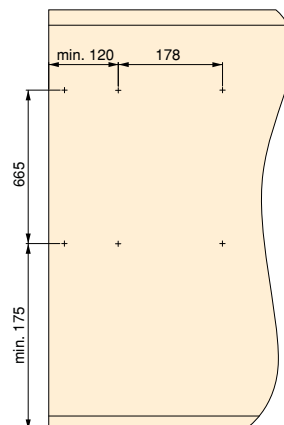

Extractable hanger for wardrobe
 Wysuwany wieszak do szafy

Finishing/Wykończenie	Packaging/Opakowanie	Cod.
Black painted/Malowane na czarno	1 Unit/Szt	6916314

Aluminium/Aluminium

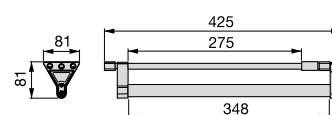

Self extractable hanger for very deep wardrobes
 Wsuwany wieszak do szafy Self

Longitude/Długość	Finishing/Wykończenie	Packaging/Opakowanie	Cod.
800	Black painted/Malowane na czarno	1 Unit/Szt	7005714

Plastic, Steel/Plastik, Stal

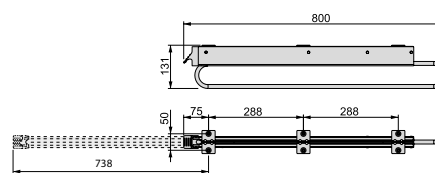

Lader Bookcases
Szafka Lader



Structure for Lader bookcases
Stelaż do szafki Lader



Height/Wysokość	Finishing/Wykończenie	Packaging/Opakowanie	Cod.
830	Black painted/Malowane na czarno	1 Pair/Kpl.	4450014
1150	Black painted/Malowane na czarno	1 Pair/Kpl.	4450114
1790	Black painted/Malowane na czarno	1 Pair/Kpl.	4450314

Steel/Stal

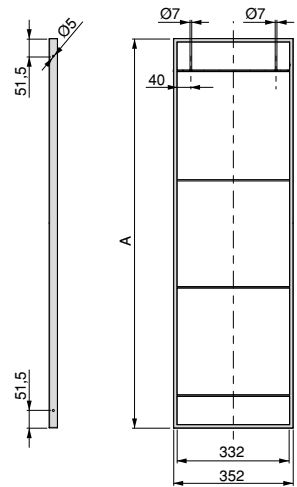

Lader Bookcases with structure and shelves
Szafka Lader ze stelażem i półkami



Width/Szerokość	Height/Wysokość	Finishing/Wykończenie	Packaging/Opakowanie	Cod.
690	1150	Black painted/Malowane na czarno	1 KIT/Zestaw	4450214

Steel, Wood/Drewno, Stal

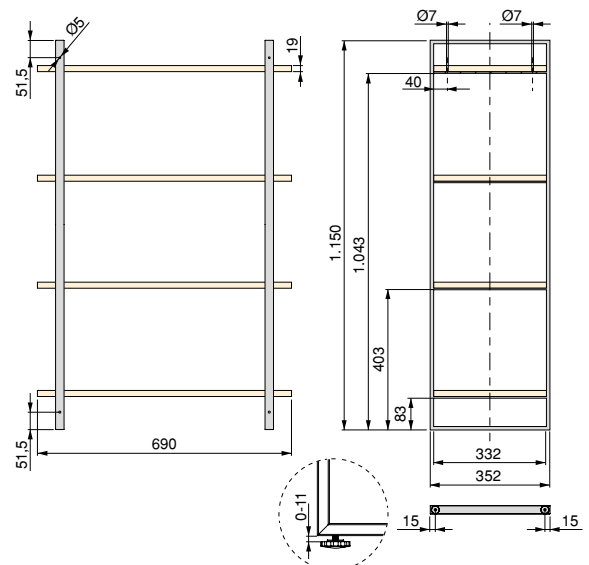

Plus profiles
Profile Plus

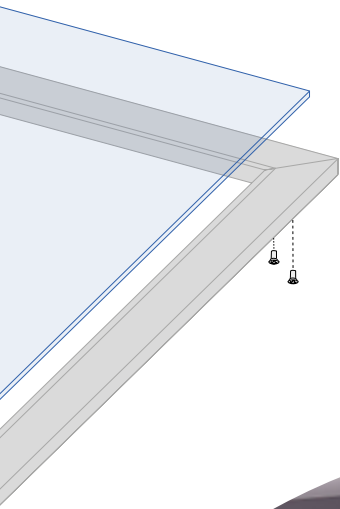

Profile for making cabinet doors Plus 4
Profil do wykonania drzwi szafy Plus 4

Longitude/Długość	Finishing/Wykończenie	Packaging/Opakowanie	Cod.
2.35 m	Textured black painted/Teksturowana czerń 	8 Unit/Szt	6304354

Aluminium/Aluminium

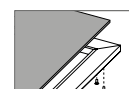
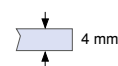
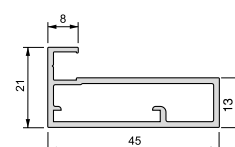
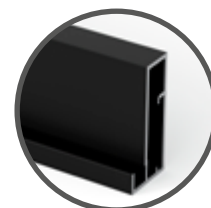

Profile for making cabinet doors Plus 7
Profil do wykonania drzwi szafy Plus 7

Longitude/Długość	Finishing/Wykończenie	Packaging/Opakowanie	Cod.
2.35 m	Textured black painted/Teksturowana czerń 	20 Unit/Szt	7025254

Aluminium/Aluminium

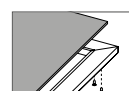
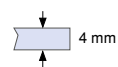
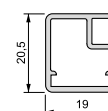
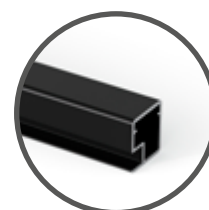

Corners for Plus 4 - 11 - 14 - 18 profiles

Wsporniki do profilu Plus 4 - 11 - 14 - 18

Description/Opis	Finishing/Wykończenie	Packaging/Opakowanie	Cod.
Black screws/Czarne śruby	Black painted/Malowane na czarno	10 KIT/Zestaw	710120

Steel/Stal

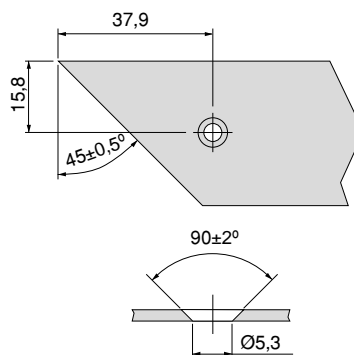

Corners for Plus 7 profiles

Wsporniki do profilu Plus 7

Description/Opis	Finishing/Wykończenie	Packaging/Opakowanie	Cod.
Black screws/Czarne śruby	Black painted/Malowane na czarno	10 KIT/Zestaw	7101220

Steel/Stal

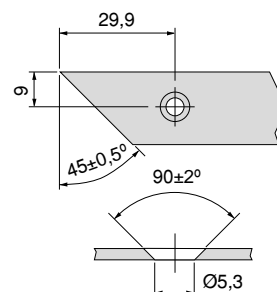

Gasket for Plus 4 - 7 - 18 profiles

Gałka do profilu Plus 4 - 7 - 18

Description/Opis	Longitude/Długość	Finishing/Wykończenie	Packaging/Opakowanie	Cod.
Gasket for 4 mm glass/Uszczelka do szyby 4 mm	2.35 m	Black plastic/Czarny plastik 	20 Unit/Szt	7921017

Plastic/Plastik



Flow System Systemy Flow



System for 2 wooden doors supported by a top glider designed for furniture installation.
 4 mm height adjustment of the sliders using a screw.
 Includes adjustment locking on the sliders.
 Sliders with ball bearings on both the lower sliders and upper guides.
 Option of 30 kg and 50 kg soft closing.

System do 2 podpartych drzwi drewnianych z prowadnicą górną przeznaczony do montażu w meblach.
 Regulacja wysokości wózków o 4 mm za pomocą śruby.
 W komplecie blokada regulacji na wózkach.
 Wózki na łożyskach kulkowych zarówno na dolnych wózkach jak i na górnych prowadnicach.
 Opcja miękkiego zamykania 30 kg i 50 kg.

Flow door soft closing for sliding door
Miękkie zamykanie Flow do bramy przesuwnej



Load/Ladunek	Finishing/Wykończenie		Packaging/Opakowanie	Cod.
30 Kg	Not defined/Nieokreślone	<input type="checkbox"/>	5 Unit/Szt	4954220
50 Kg	Not defined/Nieokreślone	<input type="checkbox"/>	5 Unit/Szt	4954320

Plastic, Steel/Plastik, Stal



	NORMAL
FLOW	X= min.120mm
FLOW2	X= min.105mm

Reversed soft closing Flow for a sliding door
Odwrócone łagodne zamykanie Flow dla drzwi przesuwnych

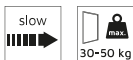

Load/Ladunek	Finishing/Wykończenie		Packaging/Opakowanie	Cod.
30 Kg	Not defined/Nieokreślone	<input type="checkbox"/>	5 Unit/Szt	6119220
50 Kg	Not defined/Nieokreślone	<input type="checkbox"/>	5 Unit/Szt	6119320

Plastic, Steel/Plastik, Stal



	INVERTED
FLOW	X= min.30mm
FLOW2	X= min.60mm

Allows the upper and lower carriages to be mounted symmetrically.

Umożliwia symetryczny montaż górnego i dolnego wózka.

Flow brake for sliding door
Hamulec Flow do drzwi przesuwnych

Finishing/Wykończenie		Packaging/Opakowanie	Cod.
Grey plastic/Szary plastik	<input type="checkbox"/>	40 Unit/Szt	6114921

Plastic/Plastik

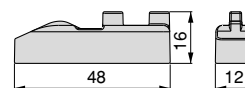

Flow set for one sliding door for sliding door
Wózki i prowadnice Flow do drzwi przesuwnych



Load/Ladunek	Finishing/Wykończenie	Packaging/Opakowanie	Cod.
50 Kg	Not defined/Nieokreślone	5 KIT/Zestaw	4954120

Plastic, Steel/Plastik, Stal



	X
NORMAL	min. 120mm
INVERTED	min. 30mm
No SLOW	min. 30mm

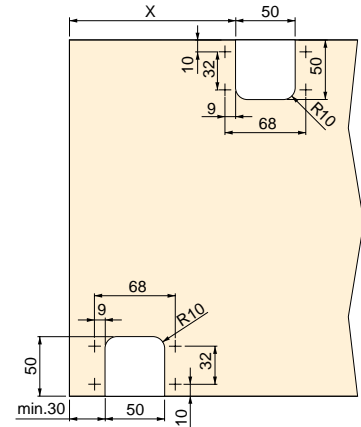

Flow 2 set for one sliding door for sliding door
Wózki i prowadnice Flow 2 do drzwi przesuwnych



Load/Ladunek	Finishing/Wykończenie	Packaging/Opakowanie	Cod.
50 Kg	Black plastic/Czarny plastik	5 Pair/Kpl.	6119117

Plastic, Steel/Plastik, Stal

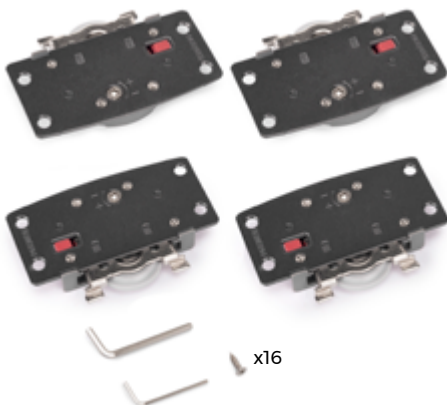

	X	W
NORMAL	min. 150mm	min. 111mm
INVERTED	min. 60mm	min. 21mm
No SLOW	min. 60mm	min. 21mm

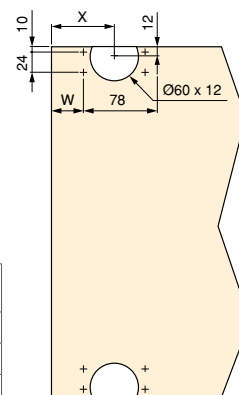

OPTION - 1

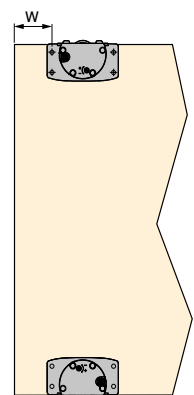

OPTION - 2

Flow upper track for surface mounting
Szyna górna Flow do montażu powierzchniowego

Longitude/Długość	Finishing/Wykończenie		Packaging/Opakowanie	Cod.
2,35 m	Black painted/Malowane na czarno	■	10 Unit/Szt	6213014
3,9 m	Black painted/Malowane na czarno	■	10 Unit/Szt	6213114

Aluminium/Aluminium

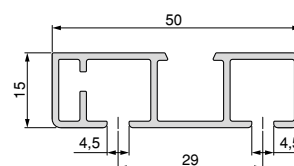

Flow lower track for surface mounting
Szyna dolna Flow do montażu powierzchniowego

Longitude/Długość	Finishing/Wykończenie		Packaging/Opakowanie	Cod.
2,35 m	Black painted/Malowane na czarno	■	10 Unit/Szt	6213214
3,9 m	Black painted/Malowane na czarno	■	10 Unit/Szt	6213314

Aluminium/Aluminium

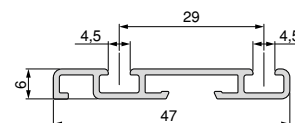



Clips for Flow tracks for surface mounting
Zaciski do szyn Flow do montażu powierzchniowego

Finishing/Wykończenie	Packaging/Opakowanie	Cod.
Grey plastic/Szary plastik 	40 Unit/Szt	6213421

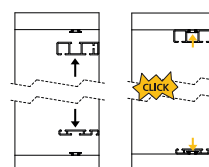
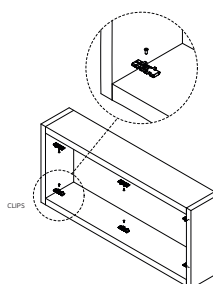
Plastic/Plastik



Flow upper and lower track for sliding door
Tor górny i dolny do drzwi przesuwnych

Longitude/Długość	Finishing/Wykończenie	Packaging/Opakowanie	Cod.
2,35 m	Black anodized/Czarny anodowany 	20 Unit/Szt	4954967
3,9 m	Black anodized/Czarny anodowany 	20 Unit/Szt	4954467

Aluminium/Aluminium

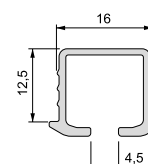
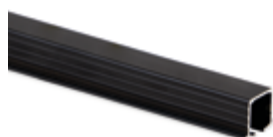

Flow cover for sliding door
Pokrywa Flow do drzwi przesuwnych

Finishing/Wykończenie	Packaging/Opakowanie	Cod.
Black plastic/Czarny plastik 	40 Unit/Szt	6114817

Plastic/Plastik

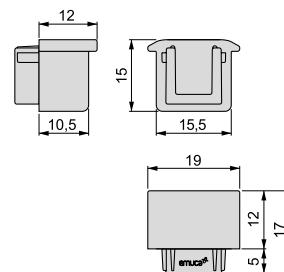

Barn System Systemy Barn

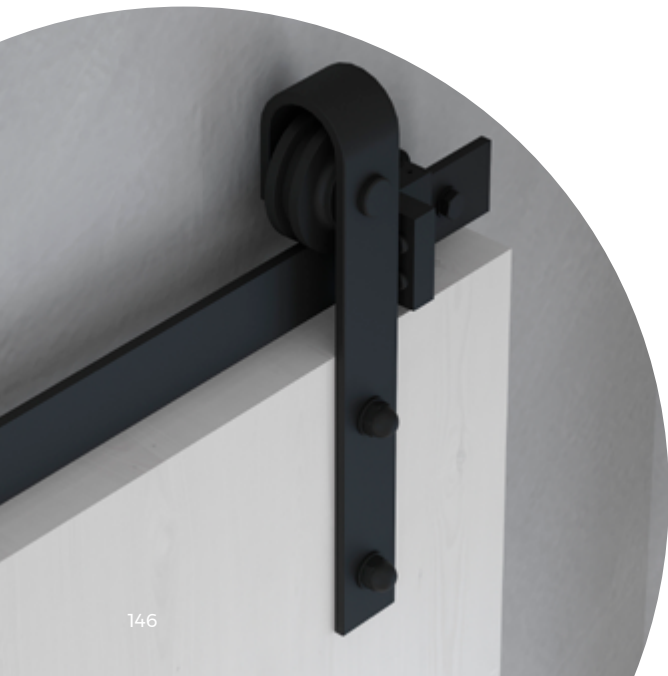
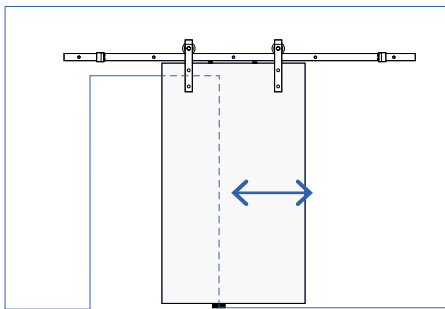

System for hanging wooden sliding doors, ideal for achieving both a rustic and modern atmosphere.

With a load capacity of up to 80 kg and thicknesses of wooden doors from 35 to 45 mm.

The kit includes a 2 meter profile with its stops, two trolleys for a door, accessories and installation and fixing screws. The boards are not included.

Easy installation process and smooth rolling.

Made of steel with a black painted finish.

System przesuwny do drzwi drewnianych podwieszanych, idealnie nadadzą pomieszczeniu zarówno rustykalny, jak i nowoczesny wygląd.

Udźwig do 80 kg i grubość skrzydeł drzwi drewnianych od 35 do 45 mm.

Zestaw zawiera 2-metrowy profil z ogranicznikami, dwa wózki na jedne drzwi, akcesoria oraz wkręty montażowe i mocujące. Płyty nie objęte w zestawie.

Łatwy montaż i płynna praca.

Wykonany ze stali malowanej na czarno

Barn system for suspended wooden sliding doors

System Barn do drzwi przesuwnych podwieszonych z drewna.

Description/Opis	Load/Ladunek	Finishing/Wykończenie	Packaging/Opakowanie	Cod.
Without soft close/Bez cichego domyku	80 kg	Black painted/Malowane na czarno	1 Unit/Szt	6116514
With soft close/Z cichym domykiem	60 kg	Black painted/Malowane na czarno	1 Unit/Szt	6116614

Plastic, Steel/Plastik, Stal



Without soft close/Bez cichego domyku



With soft close/Z cichym domykiem

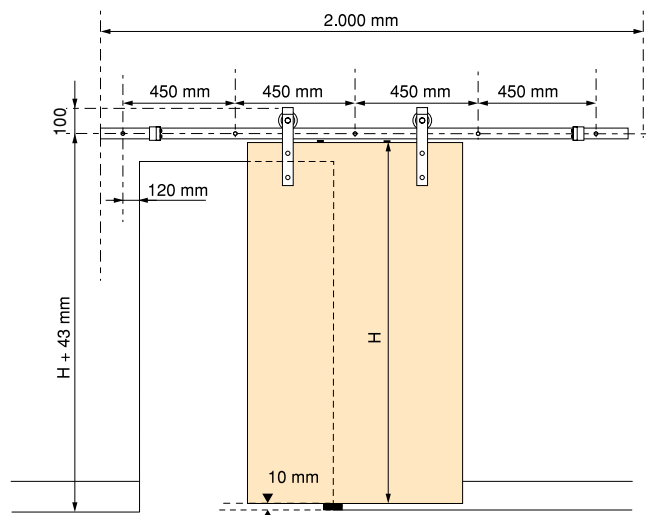

Placard System Systemy Placard

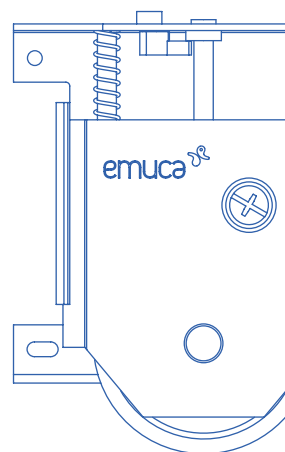
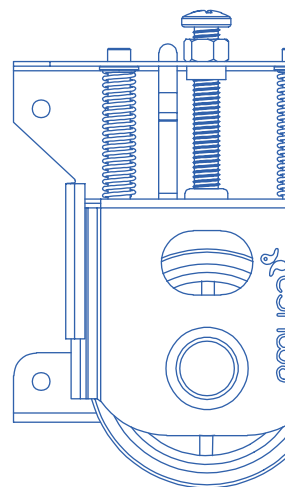

Suitable for 2 and 3 door wardrobe.

Ball bearing rollers.

Height adjustable undercarriage ± 7.5 mm with brakes or ± 5 mm with Soft.

Anti-derailment system with a spring in the bottom roller and adjustable top rollers.

The top rollers can be blocked to install the door easily.

Soft opening and closing mechanism for 2 door wardrobe.

Top brake system allows the doors to move doors in both directions.

Pasuje do szaf z 2 i 3 drzwiami.

Rolki z łożyskiem kulkowym.

Podwozie o regulowanej wysokości $\pm 7,5$ mm z hamulcami lub ± 5 mm z systemem Soft.

System zabezpieczający przed wypadnięciem z szyn ze sprężyną w rolce dolnej i regulowanymi rolkami górnymi.

Górne rolki można zablokować, aby ułatwić montaż drzwi.

Mechanizm cichego otwierania i zamykania do szaf z 2 drzwiami.

Górny system hamulcowy umożliwia przesuwanie drzwi w obu kierunkach.

Set of soft-closing Placard 74 for 1 sliding door

Zestaw okuć do drzwi ze spowalniczem

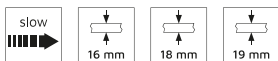

Load/Ladunek	Board thickness/Grubość płyty	Finishing/Wykończenie	Packaging/Opakowanie	Cod.
30 Kg	16 - 18 - 19	Not defined/Nieokreślone <input type="checkbox"/>	2 Unit/Szt	6108320
50 Kg	16 - 18 - 19	Not defined/Nieokreślone <input type="checkbox"/>	2 Unit/Szt	6108420

Plastic/Plastik



Set of fittings Placard with $\varnothing 45$ wheel for 1 door for sliding 70kg for soft-closing

Zestaw okuć Tabliczka z kółkiem $\varnothing 45$ na 1 drzwi przesuwne 70kg do miękkiego domykania

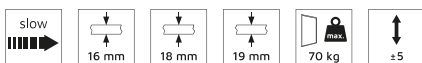

Model/Model	Finishing/Wykończenie	Packaging/Opakowanie	Cod.
Croove/Z rowkami	Not defined/Nieokreślone <input type="checkbox"/>	4 Pair/Kpl.	6188720

Plastic, Steel/Plastik, Stal



Set of fittings Placard with Ø50 wheel for 1 door for sliding 70kg for soft-closing
Zestaw okuć do drzwi dostosowanych do spowalnicza

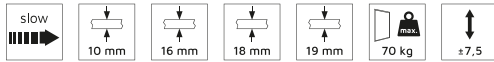

Model/Model	Finishing/Wykończenie	Packaging/Opakowanie	Cod.
Groove/Z rowkami	Not defined/Nieokreślone <input type="checkbox"/>	4 Unit/Szt	6108020

Acero, Plástico/Aço, Plástico



Set of fittings Placard 74 with Ø45 wheel for 1 door for sliding 70kg with brake
Zestaw wózków Placard 74 z kółkami Ø45 dla jednych drzwi przesuwanych do 70 kg z hamulcami

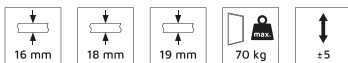

Model/Model	Finishing/Wykończenie	Packaging/Opakowanie	Cod.
Groove/Z rowkami	Not defined/Nieokreślone <input type="checkbox"/>	4 Pair/Kpl.	6188920

Plastic, Steel/Plastik, Stal



Set of fittings Placard 74 with Ø50 wheel for 1 door for sliding 70kg with brake
Zestaw okuć do drzwi bez spowalnicza 70 Kg

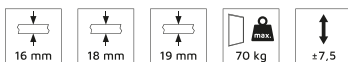

Load/Ladunek	Board thickness/Grubość płyty	Model/Model	Finishing/Wykończenie	Packaging/Opakowanie	Cod.
70 Kg	16 - 18 - 19	Groove/Z rowkami	Not defined/Nieokreślone <input type="checkbox"/>	4 Unit/Szt	6109920

Plastic, Steel/Plastik, Stal



Inferior carriage Placard with Ø45 wheel

Wózek na tabliczki z kółkiem Ø45

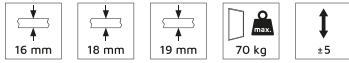

Model/Model	Finishing/Wykończenie	Packaging/Opakowanie	Cod.
Groove/Z rowkami	Zinc plated/Cynkowane	50 Unit/Szt	6188605

Plastic, Steel/Plastik, Stal

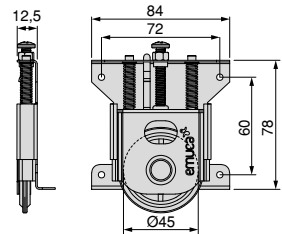

Inferior carriage Placard with Ø50 wheel

Carriage Placard do drzwi przesuwnych

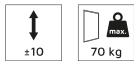

Model/Model	Finishing/Wykończenie	Packaging/Opakowanie	Cod.
Groove/Z rowkami	Black painted/Malowane na czarno	50 Unit/Szt	6102114

Plastic, Steel / Plastik, Stal

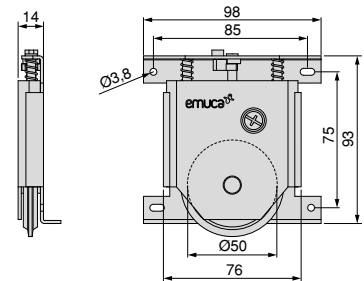

Placard 74 roller for sliding door

Rolka górna do drzwi przesuwnych

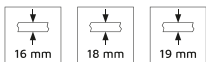

Board thickness/Grubość płyty	Finishing/Wykończenie	Packaging/Opakowanie	Cod.
16 - 18 - 19	Zinc plated/Cynkowane	100 Unit/Szt	6188805

Plastic, Steel/Plastik, Stal



Placard brake for sliding door

Hamulec do drzwi przesuwnych

Finishing/Wykończenie	Packaging/Opakowanie	Cod.
Grey plastic/Szary plastik	100 Unit/Szt	6102021

Plastic/Plastik



Classic Placard 74 upper track of Groove for sliding door
Tor górny dla Placard 74 do drzwi przesuwnych

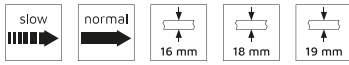

Longitude/Długość	Finishing/Wykończenie	Packaging/Opakowanie	Cod.
2,35 m	Black painted/Malowane na czarno	8 Unit/Szt	6056914
3,9 m	Black painted/Malowane na czarno	8 Unit/Szt	6054514

Aluminium/Aluminium

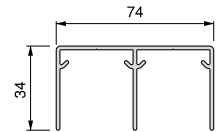
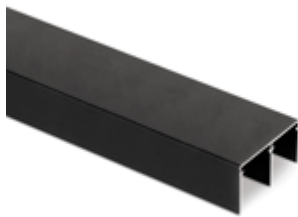

Placard 74 lower track of Groove
Tor górny Placard 74

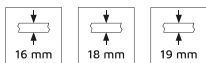

Longitude/Długość	Finishing/Wykończenie	Packaging/Opakowanie	Cod.
3,9 m	Black painted/Malowane na czarno	8 Unit/Szt	6054814

Aluminium/Aluminium

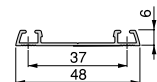

Placard 74 lower track of Groove with Clip systems for sliding door
Dolna szyna Channel Placard 74, wpuszczony klips do drzwi przesuwnych

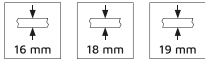

Longitude/Długość	Finishing/Wykończenie	Packaging/Opakowanie	Cod.
2,35 m	Black painted/Malowane na czarno	8 Unit/Szt	6300114
3,9 m	Black painted/Malowane na czarno	8 Unit/Szt	6055114

Aluminium/Aluminium

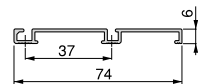

Clip for sliding-door tracks Placard for sliding doors
Zatrask do drzwi przesuwnych Placard

Finishing/Wykończenie	Packaging/Opakowanie	Cod.
Black plastic/Czarny plastik	25 Unit/Szt	6009017

Plastic/Plastik

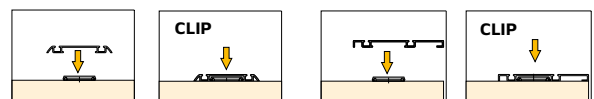
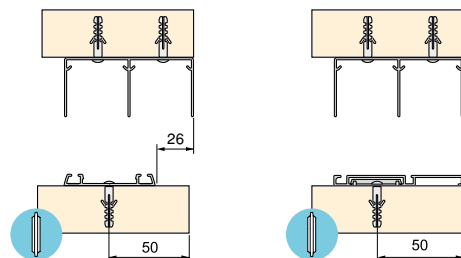

Handle for wardrobe Sharp 16
Uchwyt do szafy Sharp 16



Longitude/Długość	Finishing/Wykończenie	Packaging/Opakowanie	Cod.
2,35 m	Black painted/Malowane na czarno	8 Unit/Szt	6306714
2,7 m	Black painted/Malowane na czarno	8 Unit/Szt	6053414

Aluminium/Aluminium

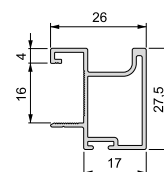
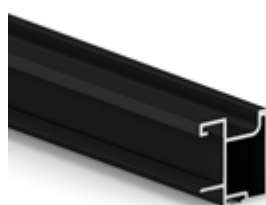

Handle for wardrobe Sharp 18
Uchwyt do szafy Sharp 18



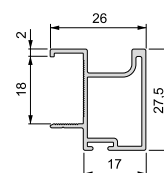
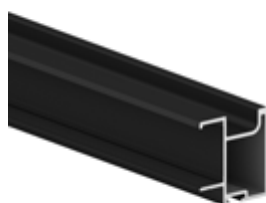

Longitude/Długość	Finishing/Wykończenie	Packaging/Opakowanie	Cod.
2,35 m	Black painted/Malowane na czarno	8 Unit/Szt	6057114
2,9 m	Black painted/Malowane na czarno	8 Unit/Szt	6053814

Aluminium/Aluminium



Handle for wardrobe Sharp 19
Uchwyt do szafy Sharp 19



Longitude/Długość	Finishing/Wykończenie	Packaging/Opakowanie	Cod.
2,35 m	Black painted/Malowane na czarno 	8 Unit/Szt	6307314
2,7 m	Black painted/Malowane na czarno 	8 Unit/Szt	6054214

Aluminium/Aluminium

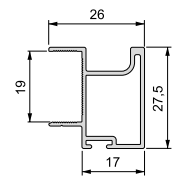
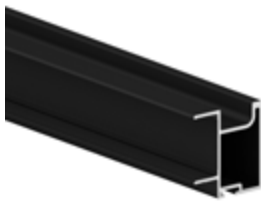

Crossbeams Placard H16x18

Perfil Placard H16x18



Longitude/Długość	Finishing/Wykończenie	Packaging/Opakowanie	Cod.
2,35 m	Black painted/Malowane na czarno	8 Unit/Szt	6300814

Aluminium/Aluminium

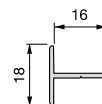

Cross-pieces Placard H18x12/22

Elementy poprzeczne Placard H18x12/22



Longitude/Długość	Finishing/Wykończenie	Packaging/Opakowanie	Cod.
2,35 m	Black painted/Malowane na czarno	8 Unit/Szt	6305614
2,35 m	Gris antracita/Gris antracite	8 Unit/Szt	6305635

Aluminium/Aluminium

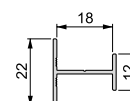

Crossbeams Placard H19x12/22

Perfil Placard Profil H19x12/22



Longitude/Długość	Finishing/Wykończenie	Packaging/Opakowanie	Cod.
2,35 m	Black painted/Malowane na czarno	8 Unit/Szt	6102914

Aluminium/Aluminium

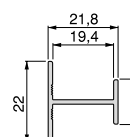

Crossbeams Placard U16x14

Perfil Placard U16x14



Longitude/Długość	Finishing/Wykończenie	Packaging/Opakowanie	Cod.
2,35 m	Black painted/Malowane na czarno 	8 Unit/Szt	6300314

Aluminium/Aluminium



Crossbeams Placard U19x14

Perfil Placard Profil U19x14



Longitude/Długość	Finishing/Wykończenie	Packaging/Opakowanie	Cod.
2,35 m	Black painted/Malowane na czarno 	8 Unit/Szt	6103114

Aluminium/Aluminium

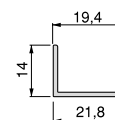

Sliding system for wardrobe 2 bottom sliding doors Placard 74 with Sharp profiles and soft closing
System przesuwany 2 dolnych drzwi Placard 74 z profilami Sharp, cichy domyk

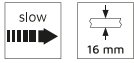

Board thickness/Grubość płyty	Finishing/Wykończenie	Packaging/Opakowanie	Cod.
16	Black painted/Malowane na czarno	1 KIT/Zestaw	6015514

Aluminium/Aluminium



KITS

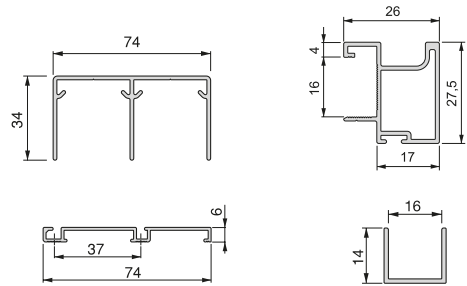

The top and bottom rails and profiles are supplied in a dimension of 2,350 mm.

Górna i dolna szyna oraz profile są dostarczane w rozmiarze 2350 mm.



Track set of Placard 74 of groove with clip systems
Zestaw prowadnic Placard z klipem

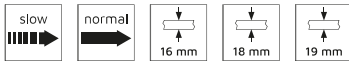

Longitude/Długość	Finishing/Wykończenie	Packaging/Opakowanie	Cod.
2,35 m	Black painted/Malowane na czarno	1 Unit/Szt	6307914
3,9 m	Black painted/Malowane na czarno	1 Unit/Szt	6055814

Aluminium/Aluminium

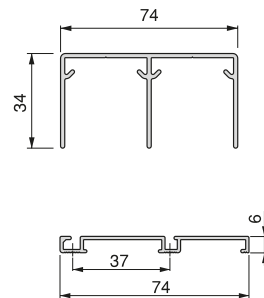
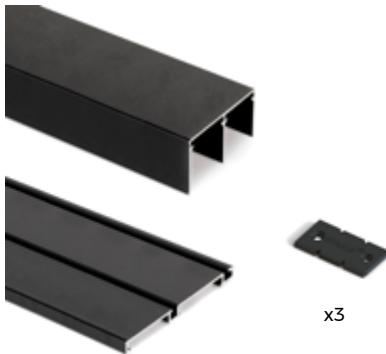

Handle profile set Sharp 16, 18 and 19 for one sliding door
Komplet uchwytów Sharp 16, 18 i 19 do drzwi

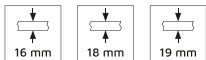

Board thickness/Grubość płyty	Longitude/Długość	Finishing/Wykończenie	Packaging/Opakowanie	Cod.
16	2,7 m	Black painted/Malowane na czarno	1 Unit/Szt	6311014
19	2,35 m	Black painted/Malowane na czarno	1 Unit/Szt	6308514
19	2,7 m	Black painted/Malowane na czarno	1 Unit/Szt	6311214

Aluminium/Aluminium

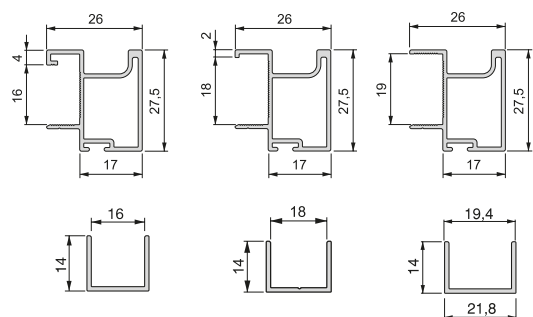

Titane system
System Titane



Titane Corner pull-out systems for furniture
Narożne systemy wysuwane do mebli



Finishing/Wykończenie	Packaging/Opakowanie	Cod.
Anthracite grey/Szary antracyt 	1 Unit/Szt	8944335

Steel, Wood/Drewno, Stal

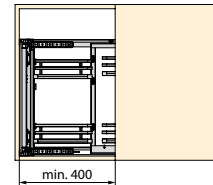
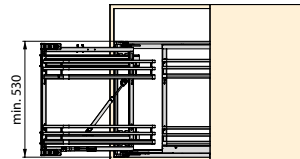

Derecha/Direita



Izquierda/Esquerda

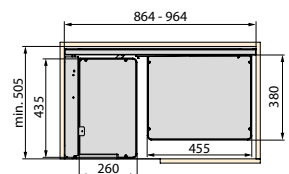
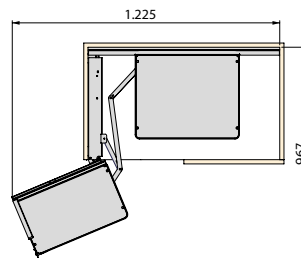

Titane pull out Corner module for kitchen furnitures
Narożnik wysuwany Titane do mebli kuchennych



Hand/Uchwyty	Finishing/Wykończenie	Packaging/Opakowanie	Cod.
Right/Prawy	Anthracite grey/Szary antracyt 	1 Unit/Szt	8939835
Left/Lewy	Anthracite grey/Szary antracyt 	1 Unit/Szt	8939935

Steel, Wood/Drewno, Stal

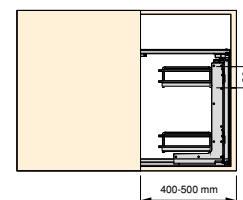
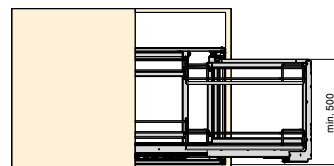
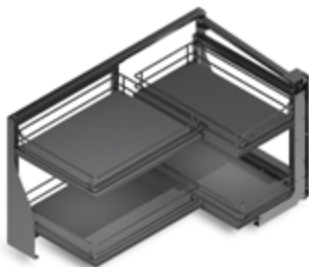

Derecha/Direita



Izquierda/Esquerda

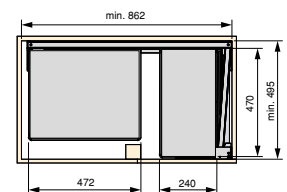
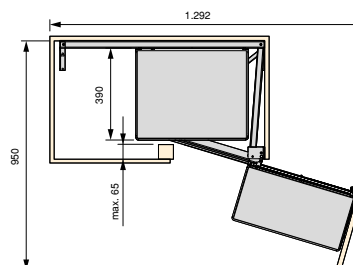

Lake Titane Corner pull out for furniture
System narożników Lake Titane do mebli



Hand/Uchwyt	Finishing/Wykończenie	Packaging/Opakowanie	Cod.
Right/Prawy	Anthracite grey/Szary antracyt	1 Unit/Szt	8946035
Left/Lewy	Anthracite grey/Szary antracyt	1 Unit/Szt	8946135

Steel, Various/Różne, Stal



Derecha/Direita

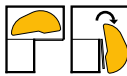

Izquierda/Esquerda

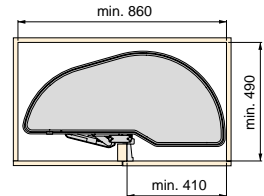
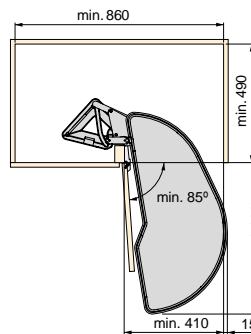
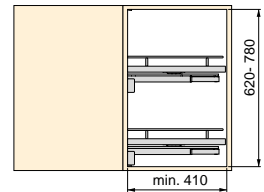
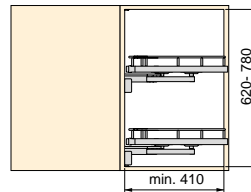
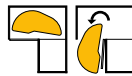

Titane Column
Colonna Titane



Finishing/Wykończenie	Packaging/Opakowanie	Cod.
Anthracite grey/Szary antracyt	1 Unit/Szt	8946235

Steel, Wood/Drewno, Stal



Derecha/Direita



Izquierda/Esquerda

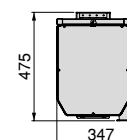
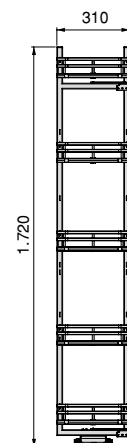

TitanMax Pull out bottle rack with soft close
Wysuwany stojak na butelki, cichy domyk, TitanMax

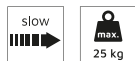

M	X	Y	Finishing/Wykończenie	Packaging/Opakowanie	Cod.
150	98	499	Anthracite grey/Szary antracyt	1 Unit/Szt	8381035
200	145	511	Anthracite grey/Szary antracyt	1 Unit/Szt	8381135

Steel/Stal

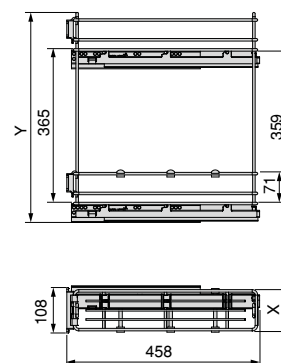

Titane Pull out bottle rack with soft close
Wysuwany stojak na butelki Titane, cichy domyk



M	X	Finishing/Wykończenie	Packaging/Opakowanie	Cod.
150	108	Anthracite grey/Szary antracyt	1 KIT/Zestaw	8946535
200	158	Anthracite grey/Szary antracyt	1 KIT/Zestaw	8946635

Steel/Stal

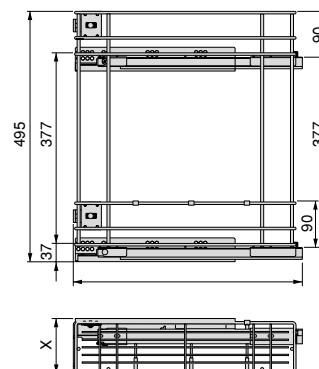

Storage kitchens Przechowywanie kuchni



Titane Profile for hanging kitchen accessories

Profil do zawieszania akcesoriów kuchennych Titane



Longitude/Długość	Finishing/Wykończenie	Packaging/Opakowanie	Cod.
1,1 m	Anthracite grey/Szary antracyt 	1 KIT/Zestaw	8965335

Aluminium, Zamak/Aluminium, Znal

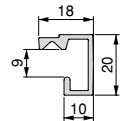

Titane hanging hooks

Haczyki ścienne Titane



Finishing/Wykończenie	Packaging/Opakowanie	Cod.
Anthracite grey/Szary antracyt 	10 Unit/Szt	8965235

Steel/Stal

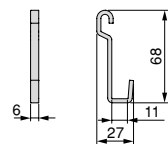

Titane tablet stand
 Uchwyt na tablet Titane



Finishing/Wykończenie	Packaging/Opakowanie	Cod.
Anthracite grey/Szary antracyt 	1 Unit/Szt	8965135

Steel/Stal

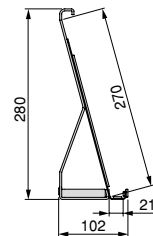
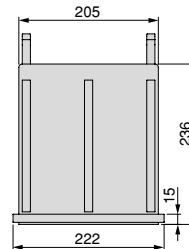

Titane kitchen knife holder
 Uchwyty na noże kuchenne Titane



Finishing/Wykończenie	Packaging/Opakowanie	Cod.
Anthracite grey/Szary antracyt 	1 Unit/Szt	8964935

Plastic, Steel/Plastik, Stal

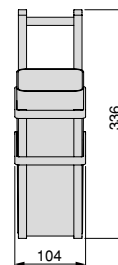
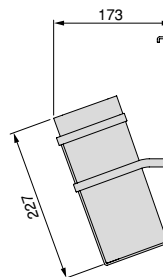

Titane kitchen cutlery holder
 Pojemnik na sztućce kuchenne Titane



Finishing/Wykończenie	Packaging/Opakowanie	Cod.
Anthracite grey/Szary antracyt 	1 Unit/Szt	8965035

Steel/Stal

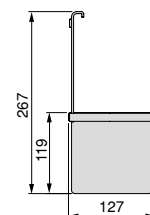
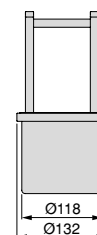

Titane kitchen utensil shelf
 Półka na przybory kuchenne Titane



Finishing/Wykończenie	Packaging/Opakowanie	Cod.
Anthracite grey/Szary antracyt 	1 Unit/Szt	8964635

Steel/Stal

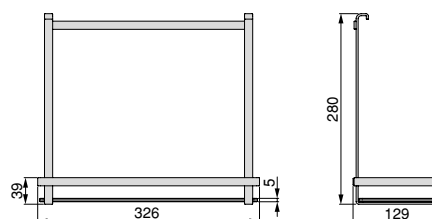

Titane shelf for spices jars
 Półka na słoiki z przyprawami Titane



Finishing/Wykończenie	Packaging/Opakowanie	Cod.
Anthracite grey/Szary antracyt 	1 Unit/Szt	8964735

Steel/Stal

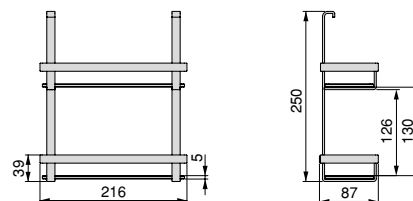

Titane kitchen roll holder
 Uchwyty na rolki kuchenny Titane



Finishing/Wykończenie	Packaging/Opakowanie	Cod.
Anthracite grey/Szary antracyt 	1 Unit/Szt	8964835

Steel/Stal

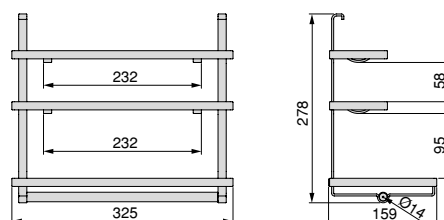

Storage kitchens Przechowywanie kuchni



Tidy bathroom drawer organizer cubes Pojemniki do organizery do szuflad łazienkowych Tidy

Set/Zestaw	Finishing/Wykończenie	Packaging/Opakowanie	Cod.
4 cubes/4 kostki	Anthraccite grey plastic/Szaro-antracytowy plastik	1 Unit/Szt	8098523
6 cubes/6 kostki	Anthraccite grey plastic/Szaro-antracytowy plastik	1 Unit/Szt	8098623

Plastic/Plastik

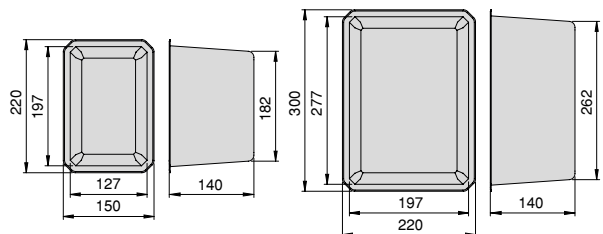

Rectangular drawer organizer with siphon saver Tidy
Prostokątny organizer do szuflad z osłoną syfonu Tidy

Finishing/Wykończenie	Packaging/Opakowanie	Cod.
Anthracite grey plastic/Szaro-antracytowy plastik 	10 Unit/Szt	8098123

Plastic/Plastik

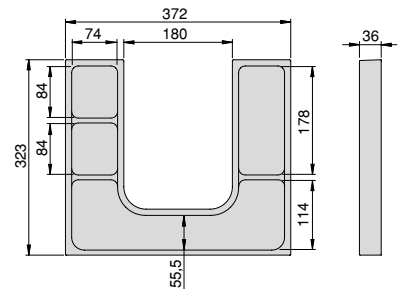

Bathroom drawer organizers sides Tidy
Organizery do szuflad łazienkowych Tidy

Finishing/Wykończenie	Packaging/Opakowanie	Cod.
Anthracite grey plastic/Szaro-antracytowy plastik 	1 Unit/Szt	8098223

Plastic/Plastik

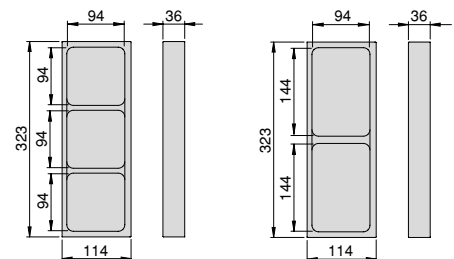

Bins for bathroom drawer organizers Tidy
Pojemniki na organizery do szuflad łazienkowych Tidy

Set/Zestaw	Finishing/Wykończenie	Packaging/Opakowanie	Cod.
10 cubes/10 kostki	Anthracite grey plastic/Szaro-antracytowy plastik 	1 Unit/Szt	8098323

Plastic/Plastik

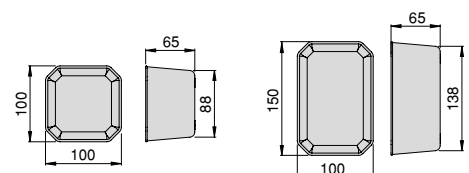

**Accessories for kitchen furniture
Akcesoria do mebli kuchennych**



Optima Cutlery tray for universal drawers

Pudełko na sztućce Óptima idealne do szuflad uniwersalnych

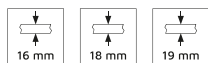

M	A	P	Finishing/Wykończenie	Packaging/Opakowanie	Cod.
400	304 - 336	418 - 482	Anthracite grey plastic/Szaro-antracytowy plastik	20 Unit/Szt	8322023
450	354 - 386	418 - 482	Anthracite grey plastic/Szaro-antracytowy plastik	20 Unit/Szt	8322123
500	404 - 436	418 - 482	Anthracite grey plastic/Szaro-antracytowy plastik	20 Unit/Szt	8322223
600	504 - 536	418 - 482	Anthracite grey plastic/Szaro-antracytowy plastik	20 Unit/Szt	8322323
700	604 - 636	418 - 482	Anthracite grey plastic/Szaro-antracytowy plastik	10 Unit/Szt	8330123
800	704 - 736	418 - 482	Anthracite grey plastic/Szaro-antracytowy plastik	10 Unit/Szt	8330223
900	804 - 836	418 - 482	Anthracite grey plastic/Szaro-antracytowy plastik	10 Unit/Szt	8330323
1.000	904 - 936	418 - 482	Anthracite grey plastic/Szaro-antracytowy plastik	10 Unit/Szt	8330423

Plastic/Plastik

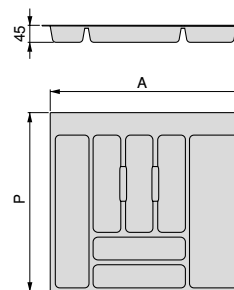

Optima Vertex/Concept/Convex 500mm cutlery tray (Board 16mm)

Pudełko na sztućce Óptima Vertex/Concept/Convex 500mm (Board 16mm)



Board thickness/Cru- bość płyty	M	A	P	Finishing/Wykończenie	Packaging/Opakowanie	Cod.
16	400	322	473	Anthracite grey plastic/Szaro-antracytowy plastik	20 Unit/Szt	8325823
16	450	372	473	Anthracite grey plastic/Szaro-antracytowy plastik	20 Unit/Szt	8325923
16	500	422	473	Anthracite grey plastic/Szaro-antracytowy plastik	20 Unit/Szt	8326023
16	600	522	473	Anthracite grey plastic/Szaro-antracytowy plastik	20 Unit/Szt	8326123
16	700	622	473	Anthracite grey plastic/Szaro-antracytowy plastik	10 Unit/Szt	8331623
16	800	722	473	Anthracite grey plastic/Szaro-antracytowy plastik	10 Unit/Szt	8331723
16	900	822	473	Anthracite grey plastic/Szaro-antracytowy plastik	10 Unit/Szt	8331823
16	1.000	922	473	Anthracite grey plastic/Szaro-antracytowy plastik	10 Unit/Szt	8331923
16	1.200	1.122	473	Anthracite grey plastic/Szaro-antracytowy plastik	10 Unit/Szt	8326623

Plastic/Plastik

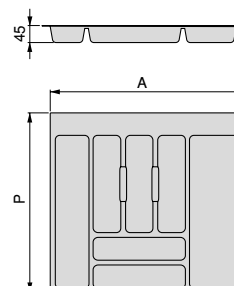

Board thickness/Cru- bość płyty	M	A	P	Finishing/Wykończenie	Packaging/Opakowa- nie	Cod.
16	400	322	473	Anthracite grey plastic/ Szaro-antracytowy plastik	1 Unit/Szt	8333023
16	450	372	473	Anthracite grey plastic/ Szaro-antracytowy plastik	1 Unit/Szt	8333123
16	500	422	473	Anthracite grey plastic/ Szaro-antracytowy plastik	1 Unit/Szt	8333223
16	600	522	473	Anthracite grey plastic/ Szaro-antracytowy plastik	1 Unit/Szt	8333323
16	700	622	473	Anthracite grey plastic/ Szaro-antracytowy plastik	1 Unit/Szt	8333423
16	800	722	473	Anthracite grey plastic/ Szaro-antracytowy plastik	1 Unit/Szt	8333523
16	900	822	473	Anthracite grey plastic/ Szaro-antracytowy plastik	1 Unit/Szt	8333623
16	1.000	922	473	Anthracite grey plastic/ Szaro-antracytowy plastik	1 Unit/Szt	8333723

Plastic/Plastik

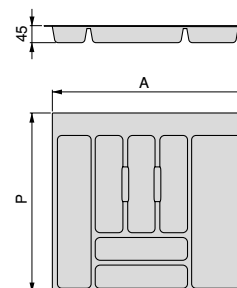

Optima Vertex / Concept 450 Cutlery Tray (18mm board)

Wkład na sztućce Optima Vertex/Concept 450 (Płyta 18 mm)



Board thickness/ Grubość płyty	M	A	P	Depth/Głębokość	Finishing/Wykończenie	Packaging/ Opakowanie	Cod.
18	500	418	423	423	Anthracite grey plastic/ Szaro-antracytowy plastik	20 Unit/Szt	8333823
18	600	518	423	423	Anthracite grey plastic/ Szaro-antracytowy plastik	20 Unit/Szt	8333923
18	800	718	423	423	Anthracite grey plastic/ Szaro-antracytowy plastik	10 Unit/Szt	8334023
18	900	818	423	423	Anthracite grey plastic/ Szaro-antracytowy plastik	10 Unit/Szt	8334123

Plastic/Plastik

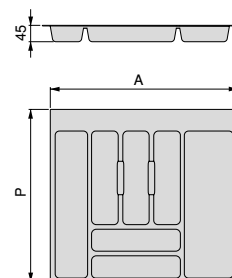

Extendable plate holder diameter 187-308 mm
 Wysuwany uchwyt na naczynia, regulowany 187-308 mm

Diametre/Średnica	Finishing/Wykończenie	Packaging/Opakowanie	Cod.
187 - 308	Grey plastic/Szary plastik	1 Unit/Szt	8017721

Plastic/Plastik

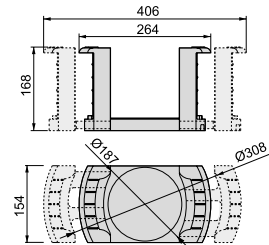

Dish organizer for furniture with capacity for 13 plates.
 Organizer na talerze do mebli na 13 talerzy.

Finishing/Wykończenie	Packaging/Opakowanie	Cod.
Anthracite grey plastic/Szaro-antracytowy plastik	1 Unit/Szt	8938523

Plastic/Plastik

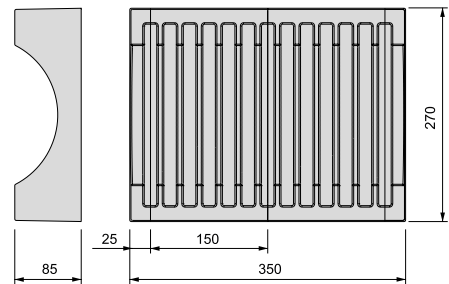

Titane spice rack with 3 shelves for kitchen furniture oder wall.
 Wieszak z 3 półeczkami Titane do szafki kuchennej lub na ścianę.

Finishing/Wykończenie	Packaging/Opakowanie	Cod.
Anthracite grey/Szary antracyt	1 Unit/Szt	8946435

Steel/Stal

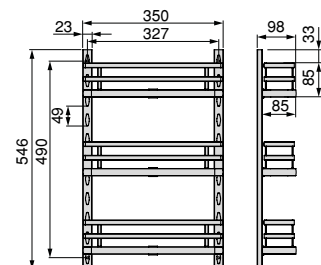

Non-slip mat for drawers
 Mata antypoślizgowa do szuflad

Longitude/Długość	Model/Model	Finishing/Wykończenie	Packaging/Opakowanie	Cod.
2000x48cm	Textile effect/Efektem tekstylnym	Anthracite grey plastic/Szaro-antracytowy plastik	1 Unit/Szt	8911323
2000x47.4cm	Textile effect/Efektem tekstylnym	Anthracite grey plastic/Szaro-antracytowy plastik	1 Unit/Szt	8911423

Plastic/Plastik

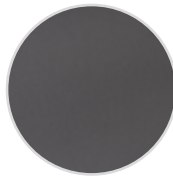
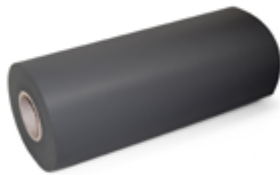

Efecto textil/Efeito têtil

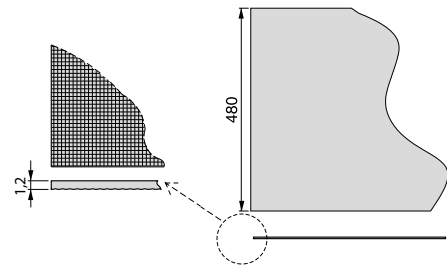

Cut-out protector for bottom of kitchen unit
 Ochrona dolnej części szafki kuchennej

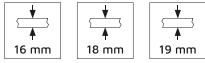

M	A	Width/Szerokość	B	Finishing/Wykończenie	Packaging/Opakowanie	Cod.
450	418	418	387	Anthracite grey plastic/Szaro-antracytowy plastik	20 Unit/Szt	8478023
500	468	468	442	Anthracite grey plastic/Szaro-antracytowy plastik	20 Unit/Szt	8478123
600	568	568	542	Anthracite grey plastic/Szaro-antracytowy plastik	20 Unit/Szt	8478223
800	768	768	742	Anthracite grey plastic/Szaro-antracytowy plastik	20 Unit/Szt	8478323
900	868	868	842	Anthracite grey plastic/Szaro-antracytowy plastik	20 Unit/Szt	8478423
1.000	968	968	942	Anthracite grey plastic/Szaro-antracytowy plastik	20 Unit/Szt	8478523
1.200	1.168	1168	1.142	Anthracite grey plastic/Szaro-antracytowy plastik	20 Unit/Szt	8478623

Plastic/Plastik

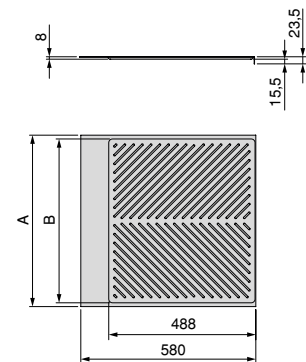
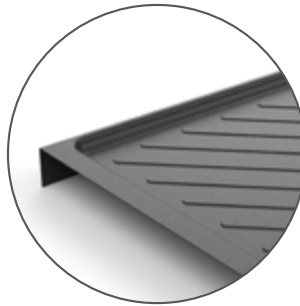
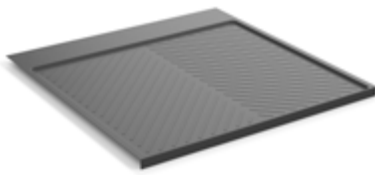

Frigo Fridge ventilation base for built-in fridges
 Podstawa wentylacyjna do lodówki Frigo

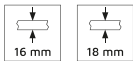

Board thickness/Grubość płyty	Finishing/Wykończenie	Packaging/Opakowanie	Cod.
16	Black plastic/Czarny plastik	1 Unit/Szt	8007117
18	Black plastic/Czarny plastik	1 Unit/Szt	8007217

Plastic/Plastik



	A	B	C	D	E	F	G
16	567,55	39,5	423,5	455,5	-	-	27
18	563,5	44	108	236	364	460	25

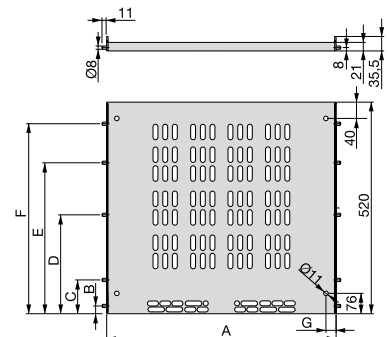

Ironing board Deska do prasowania

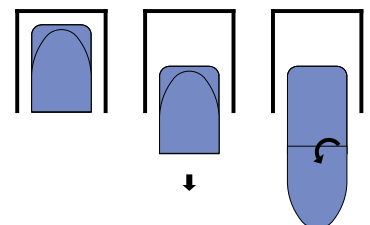
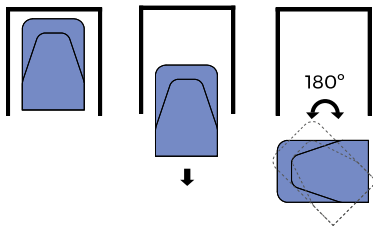

Iron 180° folding ironing board for furniture
 Składana deska do prasowania Iron 180°



Finishing/Wykończenie	Packaging/Opakowanie	Cod.
Not defined/Nieokreślone	1 Unit/Szt	8080020

Steel, Wood/Drewno, Stal

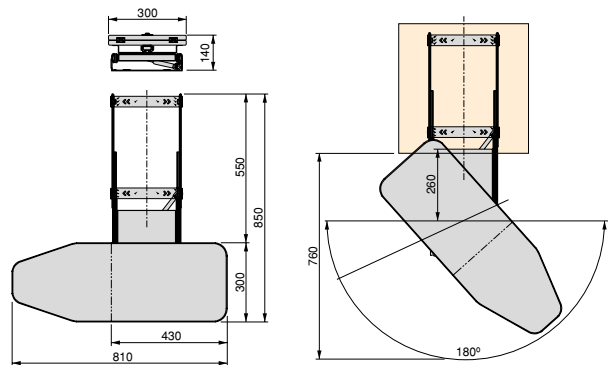

Iron2 folding ironing board for furniture
 Wysuwana deska do prasowania ze stali Iron 2



Finishing/Wykończenie	Packaging/Opakowanie	Cod.
Not defined/Nieokreślone	1 Unit/Szt	8089020

Steel, Wood/Drewno, Stal

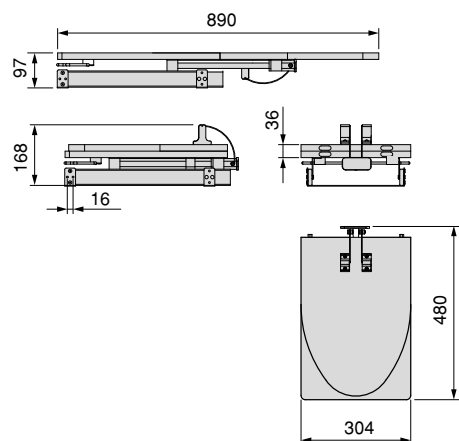

Waste containers
Pojemniki na śmieci



Recycle recycling bin for fastening to door with container 15 litres
 Pojemnik do recyklingu Recycle, montaż na drzwiach, pojemnik 15L



Finishing/Wykończenie	Packaging/Opakowanie	Cod.
Anthracite grey plastic/Szaro-antracytowy plastik 	1 Unit/Szt	8199123

Plastic/Plastik

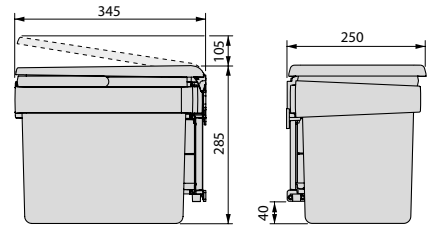
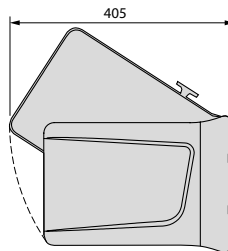

Recycle auxiliary recycling container of 5 L for kitchen
 Pomocniczy kosz do recyklingu 5 L do kuchni

Finishing/Wykończenie	Packaging/Opakowanie	Cod.
Anthracite grey plastic/Szaro-antracytowy plastik 	1 Unit/Szt	8131923

Plastic/Plastik

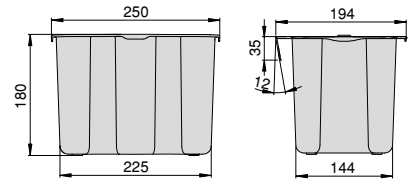

Tray for kitchen accessories, lower fixing and manual extraction
 Taca na akcesoria kuchenne, mocowanie dolne i ręczne wysuwanie



Finishing/Wykończenie	Packaging/Opakowanie	Cod.
Anthracite grey plastic/Szaro-antracytowy plastik 	1 Unit/Szt	8131623

Plastic, Steel/Plastik, Stal

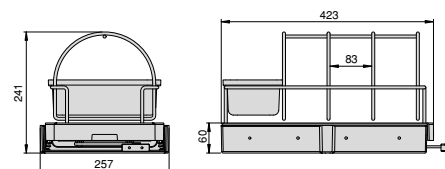

Recycle 35 L recycling bin for kitchen, lower fixing and manual removal
Kuchenny kosz na śmieci Recycle 35 L, mocowanie dolne i ręczne wysuwanie



Finishing/Wykończenie	Packaging/Opakowanie	Cod.
Anthracite grey plastic/Szaro-antracytowy plastik	1 Unit/Szt	8131823

Plastic, Steel/Plastik, Stal

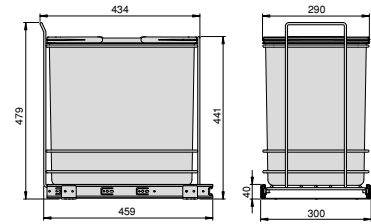

Recycle recycling bins for kitchen, 2 x 35 L, lower fixing and manual removal
Pojemniki na surowce wtórne do kuchni, 2 x 35 L, mocowanie dolne i ręczne wysuwanie

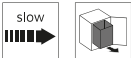

Finishing/Wykończenie	Packaging/Opakowanie	Cod.
Anthracite grey plastic/Szaro-antracytowy plastik	1 Unit/Szt	8132123

Plastic, Steel/Plastik, Stal

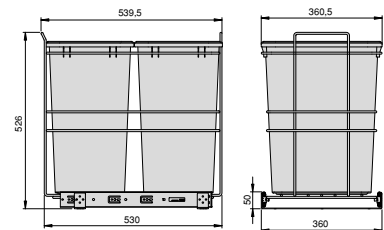

Recycle recycling bins for kitchen, 2 x 12 L, lower fixing and manual removal
Pojemniki na odpady kuchenne Recycle, 2 x 12 L, mocowanie dolne i ręczne wysuwanie



Finishing/Wykończenie	Packaging/Opakowanie	Cod.
Anthracite grey plastic/Szaro-antracytowy plastik	1 Unit/Szt	8132023

Plastic, Steel/Plastik, Stal

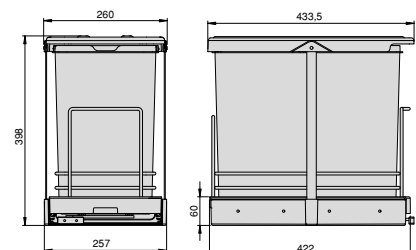

Recycle 20 L Recycling bin for kitchen, lower fixing and manual removal
Recycle 20 L pojemnik kuchenny, mocowanie na dnie i ręcznie wysuwany



Finishing/Wykończenie	Packaging/Opakowanie	Cod.
Anthracite grey plastic/Szaro-antracytowy plastik	1 Unit/Szt	8199323

Plastic/Plastik

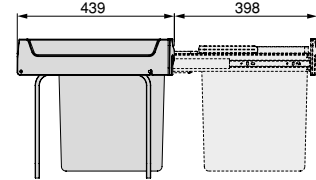
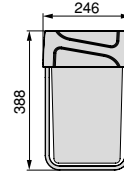

Recycle recycling bins for kitchen, 2 x 20 L, lower fixing and manual removal.
Pojemniki do recyklingu Recycle do kuchni, 2 x 20L, mocowanie na dnie i ręczne wysuwanie.



Finishing/Wykończenie	Packaging/Opakowanie	Cod.
Anthracite grey plastic/Szaro-antracytowy plastik	1 Unit/Szt	8199423

Plastic/Plastik

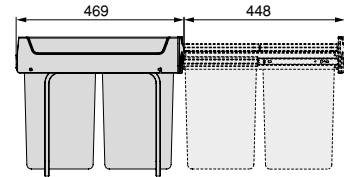
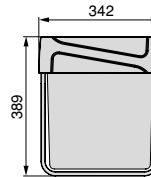

Recycling bins for kitchen, 2 x 15 L, lower fixing and manual removal.
ne pojemniki do recyklingu Emuca, 2 x 15 L, mocowanie na dnie i ręcznie wyciągane.



Finishing/Wykończenie	Packaging/Opakowanie	Cod.
Anthracite grey plastic/Szaro-antracytowy plastik	1 Unit/Szt	8199523

Plastic/Plastik

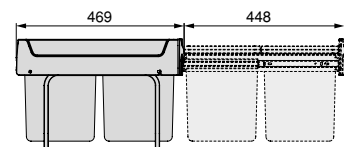
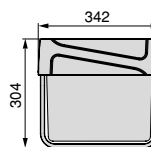

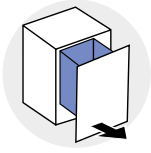

Enclosures for 450 mm and 600 mm modules.
Includes full extension slides with soft close.
Three-dimensional edge adjustment.
Compatible with 16, 18 and 19 mm panels.
Includes all necessary mounting accessories.

Obudowy dla modułów 450 mm i 600 mm.
Zawiera prowadnice z pełnym wysuwem i miękkim
domykaniem.
Trójwymiarowa regulacja krawędzi.
Kompatybilne z panelami 16, 18 i 19 mm.
Zawiera wszystkie niezbędne akcesoria montażowe.

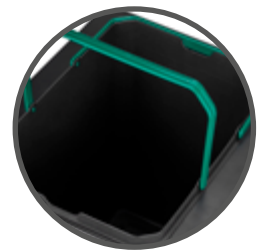
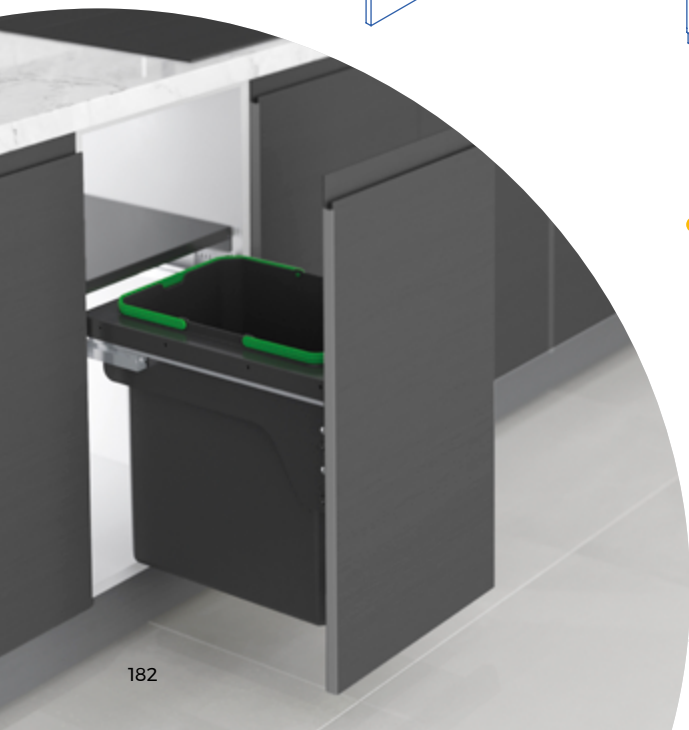
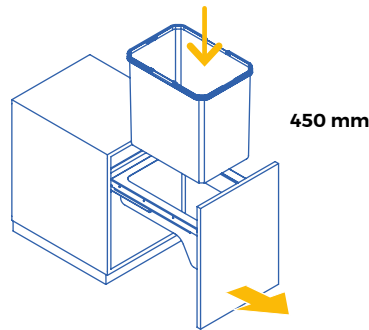
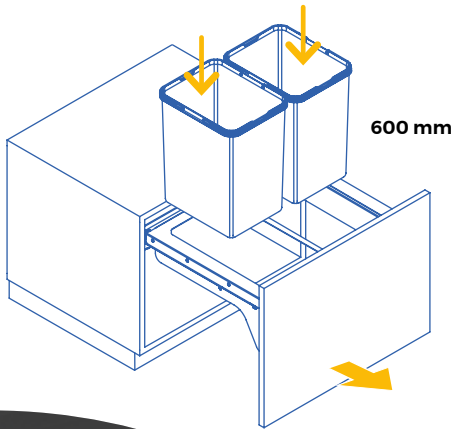
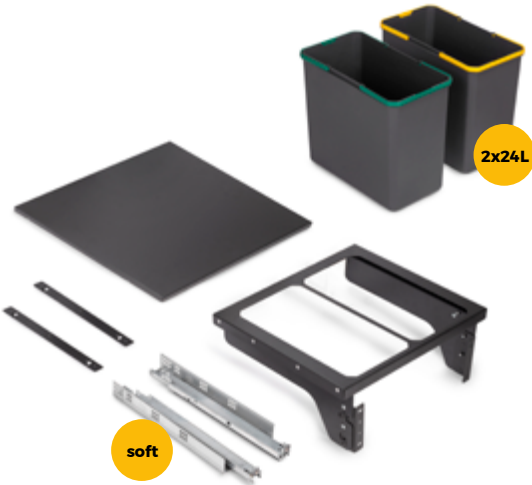



Edge adjustment in depth, horizontal
axis ± 5 mm and height ± 2.5 mm.

Regulacja krawędzi na głębokość, oś
pozioma ± 5 mm i wysokość $\pm 2,5$ mm.

Recycle 35L waste bin for kitchen with side mounting

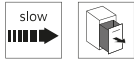
Kosz na śmieci Recycle 35L do kuchni z mocowaniem bocznym



Finishing/Wykończenie	Packaging/Opakowanie	Cod.
Anthracite grey plastic/Szaro-antracytowy plastik 	1 Unit/Szt	8966023

Plastic, Steel/Plastik, Stal

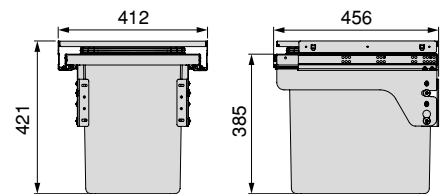
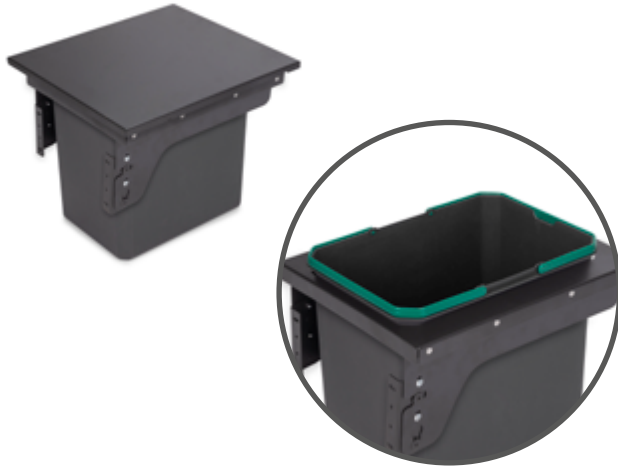

2 x 24L side-mounted kitchen waste bins

2 x 24L kosz na śmieci do kuchni z mocowaniem bocznym



Finishing/Wykończenie	Packaging/Opakowanie	Cod.
Anthracite grey plastic/Szaro-antracytowy plastik 	1 Unit/Szt	8966123

Plastic, Steel/Plastik, Stal

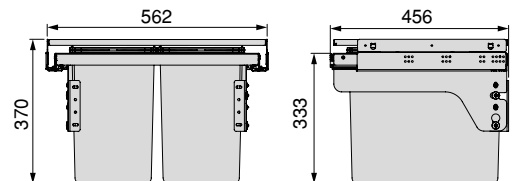

Recycle Base for containers for kitchen drawers

Podstawa Recycle pojemnika do szuflad kuchennych



Description/Opis	M	A	P	Finishing/Wykończenie	Packaging/Opakowanie	Cod.	
2 cavities/2 Komory	450	307 - 386	435 - 482	Anthracite grey plastic/ Szaro-antracytowy plastik	■	1 Unit/Szt	8196623
2 cavities/2 Komory	500	307 - 436	435 - 482	Anthracite grey plastic/ Szaro-antracytowy plastik	■	1 Unit/Szt	8196823
2 cavities/2 Komory	600	486 - 536	414 - 482	Anthracite grey plastic/ Szaro-antracytowy plastik	■	1 Unit/Szt	8196923
2 cavities/2 Komory	700	585 - 636	414 - 482	Anthracite grey plastic/ Szaro-antracytowy plastik	■	1 Unit/Szt	8197023
3 cavities/3 Komory	800	650 - 736	414 - 482	Anthracite grey plastic/ Szaro-antracytowy plastik	■	1 Unit/Szt	8197123
3 cavities/3 Komory	900	768 - 836	414 - 482	Anthracite grey plastic/ Szaro-antracytowy plastik	■	1 Unit/Szt	8197223
3 cavities/3 Komory	1000	885 - 936	414 - 482	Anthracite grey plastic/ Szaro-antracytowy plastik	■	1 Unit/Szt	8197323
4 cavities/4 Komory	1200	1.085 - 1.136	414 - 482	Anthracite grey plastic/ Szaro-antracytowy plastik	■	1 Unit/Szt	8197423



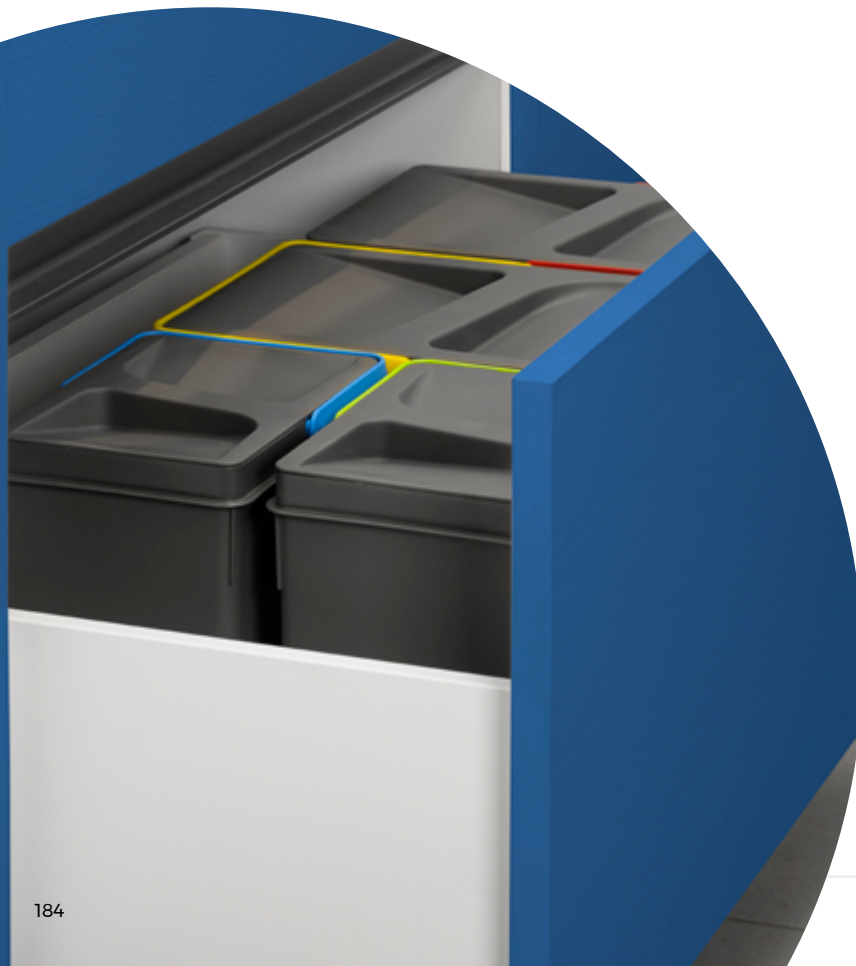
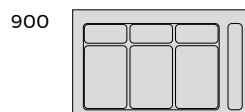
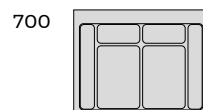
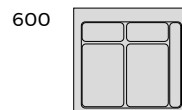
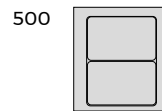
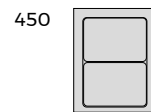
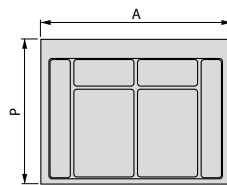
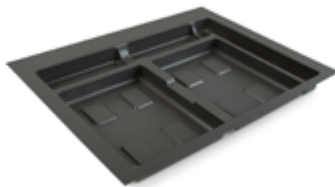



Plastic/Plastik



Recycle Containers for kitchen drawers, Height 266

Pojemniki do szuflady kuchennej Recycle, wysokość 266



Set/Zestaw	M	Finishing/Wykończenie		Packaging/Opakowanie	Cod.
1x15/1x15	450	Anthracite grey plastic/Szaro-antracytowy plastik		1 Unit/Szt	8198123
2x15/2x15	450 - 500 - 600 - 700	Anthracite grey plastic/Szaro-antracytowy plastik		1 Unit/Szt	8198223
2x7/2x7	450 - 500	Anthracite grey plastic/Szaro-antracytowy plastik		1 Unit/Szt	8198323
1x15 + 2x7/1x15 + 2x7	450 - 500 - 600 - 700	Anthracite grey plastic/Szaro-antracytowy plastik		1 Unit/Szt	8198423
2x15 + 2x7/2x15 + 2x7	800 - 900 - 1000	Anthracite grey plastic/Szaro-antracytowy plastik		1 Unit/Szt	8198523
3x15 + 2x7/3x15 + 2x7	1200	Anthracite grey plastic/Szaro-antracytowy plastik		1 Unit/Szt	8198623



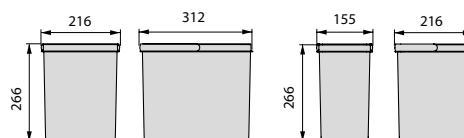



Plastic/Plastik



Recycle Containers for kitchen drawers, Height 216

Pojemniki do szuflady kuchennej Recycle, wysokość 216



Set/Zestaw	M	Finishing/Wykończenie		Packaging/Opakowanie	Cod.
1x12/1x12	450	Anthracite grey plastic/Szaro-antracytowy plastik		1 Unit/Szt	8197523
2x12/2x12	450 - 500 - 600 - 700	Anthracite grey plastic/Szaro-antracytowy plastik		1 Unit/Szt	8197623
2x6/2x6	450 - 500	Anthracite grey plastic/Szaro-antracytowy plastik		1 Unit/Szt	8197723
1x12 + 2x6/1x12 + 2x6	450 - 500 - 600 - 700	Anthracite grey plastic/Szaro-antracytowy plastik		1 Unit/Szt	8197823
2x12 + 2x6/2x12 + 2x6	800 - 900 - 1000	Anthracite grey plastic/Szaro-antracytowy plastik		1 Unit/Szt	8197923
3x12 + 2x6/3x12 + 2x6	1200	Anthracite grey plastic/Szaro-antracytowy plastik		1 Unit/Szt	8198023

Plastic/Plastik

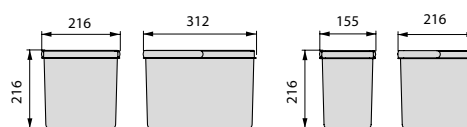

Gola Profiles Profile Gola

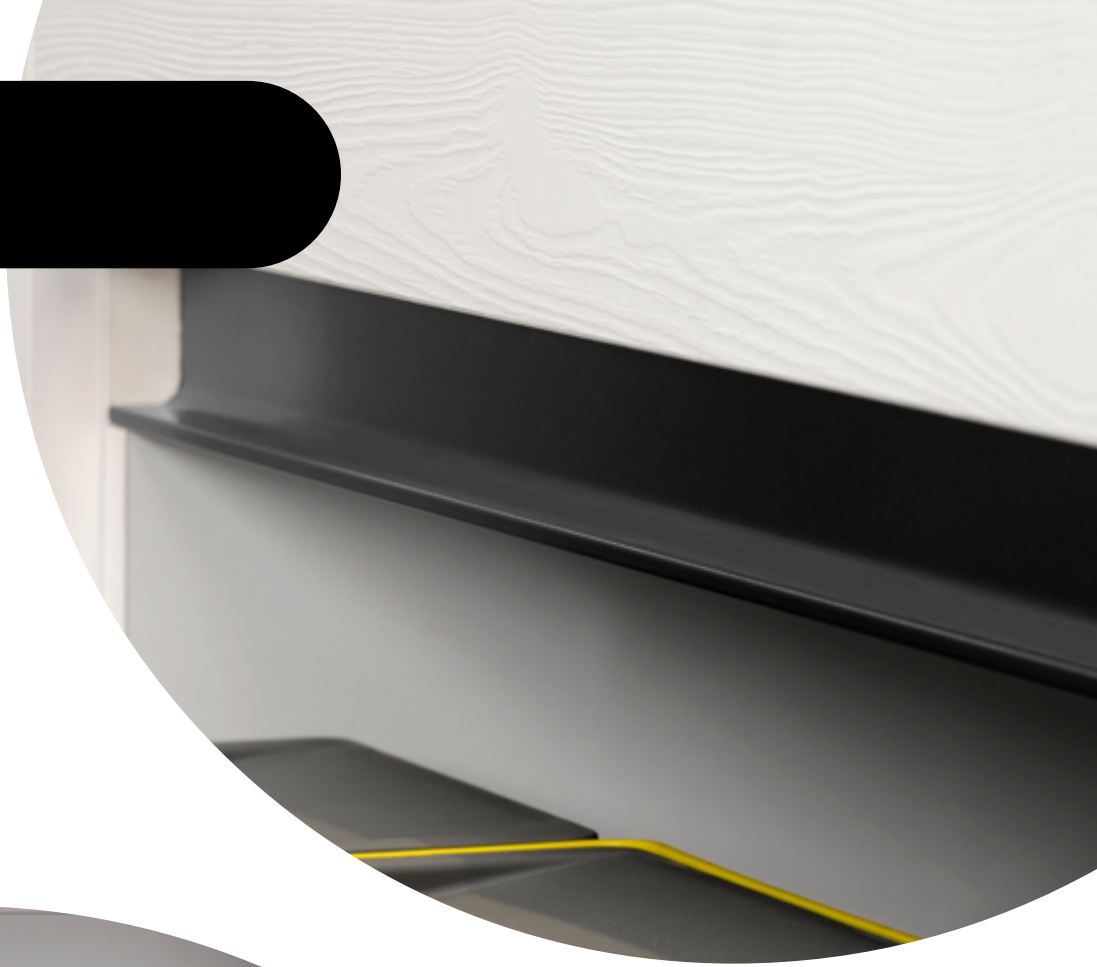

Upper profile Gola kit for kitchen furniture

Zestaw górnego profilu Gola do mebli kuchennych



Finishing/Wykończenie	Packaging/Opakowanie	Cod.
Black painted/Malowane na czarno 	1 KIT/Zestaw	8160014

Aluminium/Aluminium



KITS

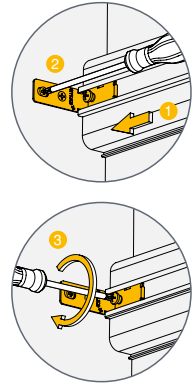
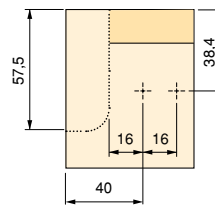

Central profile Gola kit for kitchen furniture

Zestaw środkowego profilu Gola do mebli kuchennych



Finishing/Wykończenie	Packaging/Opakowanie	Cod.
Black painted/Malowane na czarno 	1 KIT/Zestaw	8160114

Aluminium/Aluminium





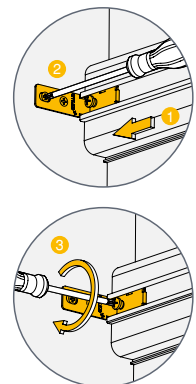
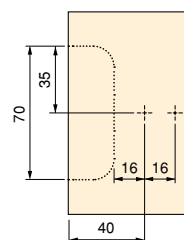

KITS



Upper Gola profile for kitchen furniture

Górny profil Gola do mebli kuchennych



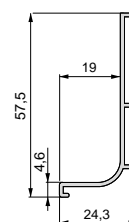
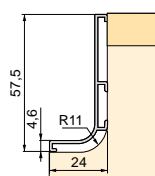
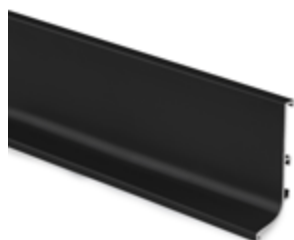

Longitude/Długość	Finishing/Wykończenie		Packaging/Opakowanie	Cod.
2,35 m	Black painted/Malowane na czarno		8 Unit/Szt	8162114
3,9 m	Black painted/Malowane na czarno		8 Unit/Szt	8900014
2,35 m	Anthracite grey/Szary antracyt		8 Unit/Szt	8162135
3,9 m	Anthracite grey/Szary antracyt		8 Unit/Szt	8900035

Aluminium/Aluminium



Central Gola profile for kitchen furniture

Profil Central Gola do mebli kuchennych

Longitude/Długość	Finishing/Wykończenie		Packaging/Opakowanie	Cod.
3,9 m	Black painted/Malowane na czarno		6 Unit/Szt	8900114
2,35 m	Black painted/Malowane na czarno		6 Unit/Szt	8162014
2,35 m	Anthracite grey/Szary antracyt		6 Unit/Szt	8162035
3,9 m	Anthracite grey/Szary antracyt		6 Unit/Szt	8900135

Aluminium/Aluminium

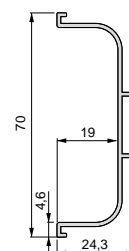
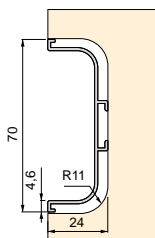
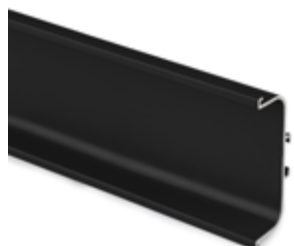

Short support A for kitchen furniture

Wspornik szybkiego montażu do mebli kuchennych

Finishing/Wykończenie	Packaging/Opakowanie	Cod.
Grey plastic/Szary plastik	40 Unit/Szt	8900621

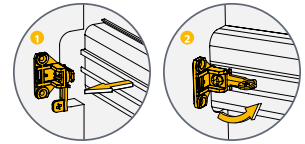
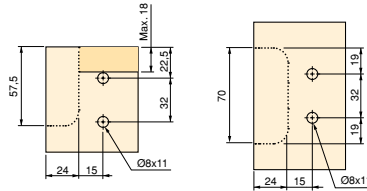

Plastic/Plastik

Long support B for kitchen furniture

Wspornik szybkiego montażu do mebli kuchennych

Finishing/Wykończenie	Packaging/Opakowanie	Cod.
Grey plastic/Szary plastik	40 Unit/Szt	8900721

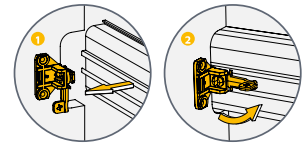
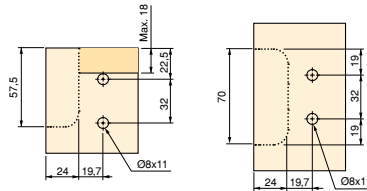

Plastic/Plastik

Bracket for Gola profile

Wspornik

Finishing/Wykończenie	Packaging/Opakowanie	Cod.
Zinc plated/Cynkowane	50 Unit/Szt	8923405

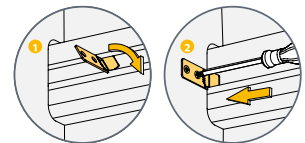
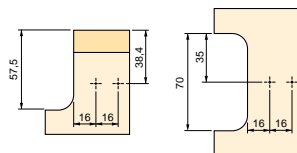

Steel/Stal

Angle bracket with expansion screw Gola

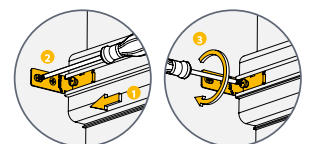
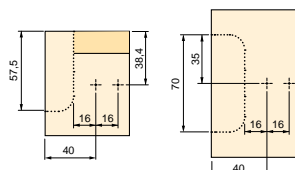

Wspornik kątowy ze śrubą rozporową

Finishing/Wykończenie	Packaging/Opakowanie	Cod.
Zinc plated/Cynkowane	50 Unit/Szt	8923505



Steel/Stal



Upper profile accessories for kitchen furniture
Akcesoria profilu górnego do mebli kuchennych

Finishing/Wykończenie	Packaging/Opakowanie	Cod.
Black plastic/Czarny plastik 	10 KIT/Zestaw	8900817
Anthracite grey plastic/Szaro-antracytowy plastik 	10 KIT/Zestaw	8900823

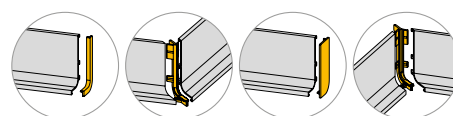
Plastic/Plastik





Central profile accessories for kitchen furniture
Akcesoria profilu centralnego do mebli kuchennych

Finishing/Wykończenie	Packaging/Opakowanie	Cod.
Black plastic/Czarny plastik 	10 KIT/Zestaw	8900917
Anthracite grey plastic/Szaro-antracytowy plastik 	10 KIT/Zestaw	8900923

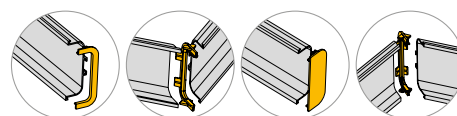
Plastic/Plastik



Gola angle upper profile for kitchen furniture
Profil górny kątowy Gola do mebli kuchennych

Description/Opis	Finishing/Wykończenie	Packaging/Opakowanie	Cod.
Inside/Wewnątrz	Anthracite grey/Szary antracyt 	1 Unit/Szt	8901135
Exterior/Zewnętrznie	Anthracite grey/Szary antracyt 	1 Unit/Szt	8901335

Aluminium/Aluminium

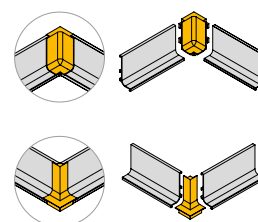

Upper Gola-R profile for kitchen furniture
Górny profil Gola-R do mebli kuchennych

Longitude/Długość	Finishing/Wykończenie		Packaging/Opakowanie	Cod.
2,35 m	Black painted/Malowane na czarno		8 Unit/Szt	8903014
3,9 m	Black painted/Malowane na czarno		8 Unit/Szt	8903214

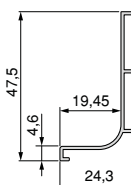
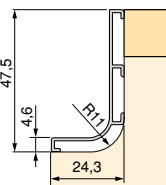
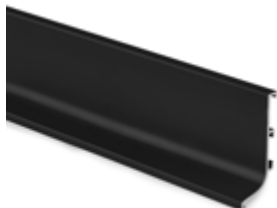

Aluminium/Aluminium



*Gola R: compatible with mounting bracket (code 8923405) and bracket with expansion screw (code 8923505).

*Gola R: kompatybilna z uchwytem montażowym (kod 8923405) i uchwytem ze śrubą rozporową (kod 8923505).

GOLA-R
Central Gola-R profile for kitchen furniture
Profil Central Gola-R do mebli kuchennych

Longitude/Długość	Finishing/Wykończenie		Packaging/Opakowanie	Cod.
2,35 m	Black painted/Malowane na czarno		6 Unit/Szt	8903114
3,9 m	Black painted/Malowane na czarno		6 Unit/Szt	8903314

Aluminium/Aluminium

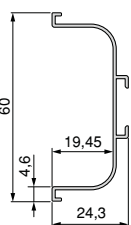
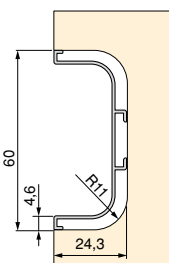

*Gola R: compatible with mounting bracket (code 8923405) and bracket with expansion screw (code 8923505).

*Gola R: kompatybilna z uchwytem montażowym (kod 8923405) i uchwytem ze śrubą rozporową (kod 8923505).

GOLA-R
Upper Gola-R profile accessories for kitchen furniture
Akcesoria profilu Gola-R górnego do mebli kuchennych

Finishing/Wykończenie		Packaging/Opakowanie	Cod.
Black plastic/Czarny plastik		10 Unit/Szt	8902517

Plastic/Plastik

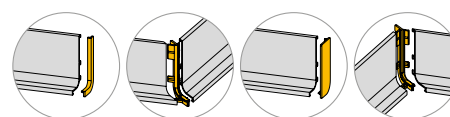
**GOLA-R**
Central Gola-R profile accessories for kitchen furniture
Akcesoria profilu Gola-R centralnego do mebli kuchennych

Finishing/Wykończenie		Packaging/Opakowanie	Cod.
Black plastic/Czarny plastik		10 Unit/Szt	8902617

Plastic/Plastik

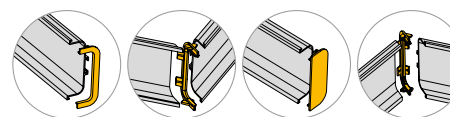
**GOLA-R**

Vertical Gola profile
Profil Gola wygięcie pionowe



Lateral profile for kitchen furniture

Boczny pionowy zakrzywiony profil Gola do mebli kuchennych

Longitude/Długość	Finishing/Wykończenie		Packaging/Opakowanie	Cod.
2.35 m	Black painted/Malowane na czarno		6 Unit/Szt	8162614
2.55 m	Black painted/Malowane na czarno		6 Unit/Szt	8900414
2.35 m	Anthracite grey/Szary antracyt		6 Unit/Szt	8162635

Aluminium/Aluminium

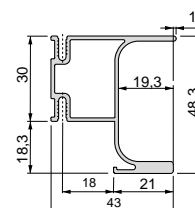
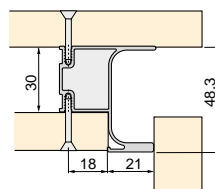
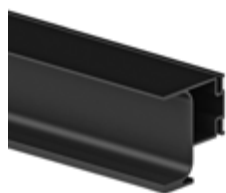

Central profile for kitchen furniture

Centralny, pionowy, zakrzywiony profil Gola do mebli kuchennych

Longitude/Długość	Finishing/Wykończenie		Packaging/Opakowanie	Cod.
2.35 m	Black painted/Malowane na czarno		6 Unit/Szt	8162514
2.55 m	Black painted/Malowane na czarno		6 Unit/Szt	8900514
2.35 m	Anthracite grey/Szary antracyt		6 Unit/Szt	8162535

Aluminium/Aluminium

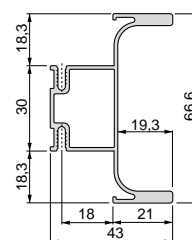
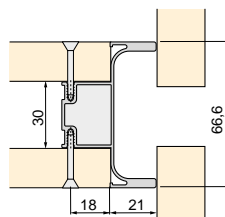
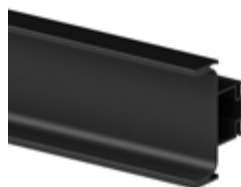

Spacer of 30 mm for curved rim profile
Dystans 30 mm do profilu Gola

Finishing/Wykończenie	Packaging/Opakowanie	Cod.
Black plastic/Czarny plastik 	100 Unit/Szt	8917917

Plastic/Plastik

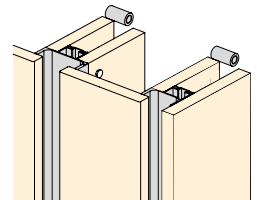
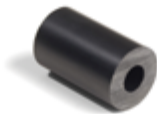

Profile Gola for oven for kitchen furniture
Profil Gola do piekarnika do mebli kuchennych



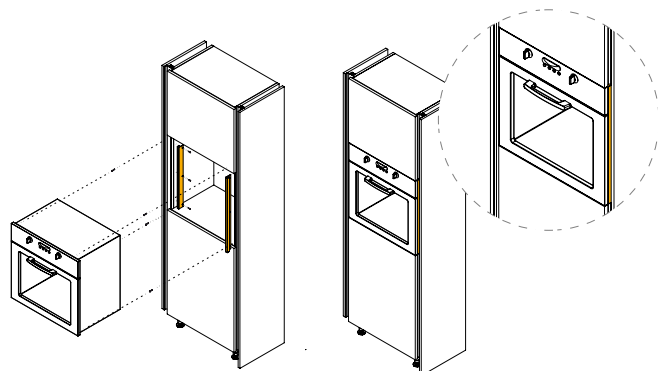
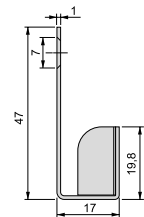
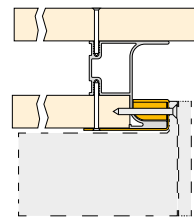

Longitude/Długość	Finishing/Wykończenie	Packaging/Opakowanie	Cod.
580 mm	Anthracite grey/Szary antracyt 	5 Unit/Szt	8902435

Aluminium/Aluminium



Gola Top pressure for kitchen furniture
 Gola Top zaciskowy do mebli kuchennych

Board thickness/Grubość płyty	Longitude/Długość	Finishing/Wykończenie	Packaging/Opakowanie	Cod.
16 mm	2,35 m	Anthracite grey/Szary antracyt 	8 Unit/Szt	8162235
19 mm	2,35 m	Anthracite grey/Szary antracyt 	8 Unit/Szt	8162435

Aluminium/Aluminium

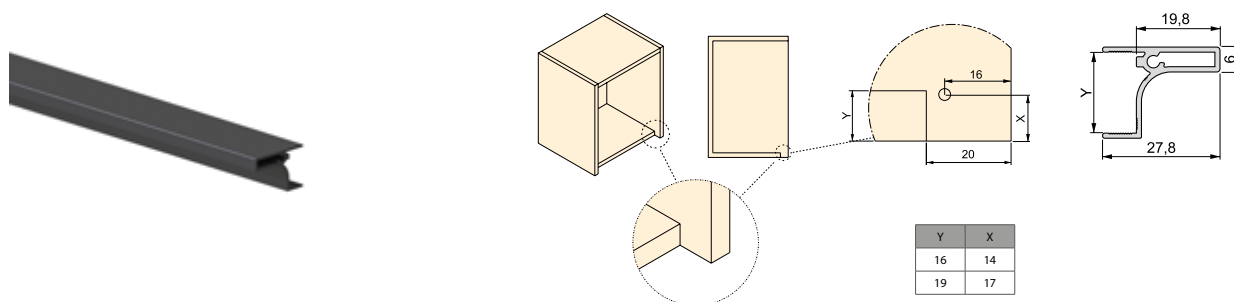

Gola top for fitting for kitchen furniture
 Gola Top do dopasowania do mebli kuchennych

Board thickness/Grubość płyty	Longitude/Długość	Finishing/Wykończenie	Packaging/Opakowanie	Cod.
18 mm	2,35 m	Anthracite grey/Szary antracyt 	8 Unit/Szt	8162335



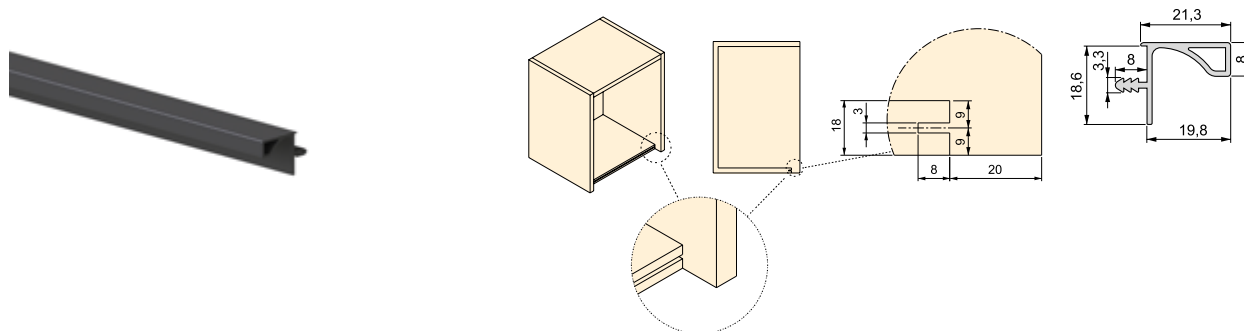

Aluminium/Aluminium



Plinth and accessories Cokoły i akcesoria



Plasline plinth for kitchen Listwy przypodłogowe Plasline do kuchni

Height/Wysokość	Longitude/Długość	Finishing/Wykończenie	Packaging/Opakowanie	Cod.
100	3,9 m	Black plastic/Czarny plastik 	10 Unit/Szt	8060117
120	3,9 m	Black plastic/Czarny plastik 	10 Unit/Szt	8060217
150	3,9 m	Black plastic/Czarny plastik 	10 Unit/Szt	8060317
100	3,9 m	Anthracite grey plastic/Szaro-antracytowy plastik 	10 Unit/Szt	8060123
150	3,9 m	Anthracite grey plastic/Szaro-antracytowy plastik 	10 Unit/Szt	8060323

Aluminium, Plastic/Aluminium, Plastik

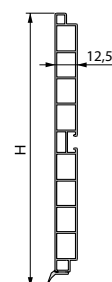

Plinth with Plasline 90° angles
Cokół kuchenny z Kąta 90°

Height/Wysokość	Finishing/Wykończenie	Packaging/Opakowanie	Cod.
100	Anthracite grey plastic/Szaro-antracytowy plastik	20 Unit/Szt	8011623
150	Anthracite grey plastic/Szaro-antracytowy plastik	20 Unit/Szt	8015623

Aluminium, Plastic/Aluminium, Plastik

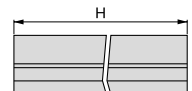
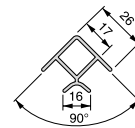

Plinth with Plasline flexible angles
Cokół kuchenny z Kąt elastyczny

Height/Wysokość	Finishing/Wykończenie	Packaging/Opakowanie	Cod.
100	Black plastic/Czarny plastik	20 Unit/Szt	8910117
150	Black plastic/Czarny plastik	20 Unit/Szt	8910317
120	Black plastic/Czarny plastik	20 Unit/Szt	8910217
100	Anthracite grey plastic/Szaro-antracytowy plastik	20 Unit/Szt	8910123
150	Anthracite grey plastic/Szaro-antracytowy plastik	20 Unit/Szt	8910323

Aluminium, Plastic/Aluminium, Plastik

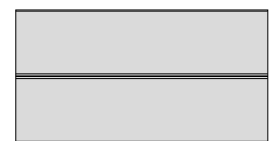
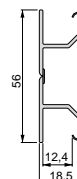
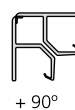
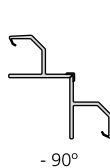

Plasline Kitchen plinth kit with union accessories
Zestaw cokołów do kuchni z akcesoriami, Plasline

Height/Wysokość	Longitude/Długość	Finishing/Wykończenie	Packaging/Opakowanie	Cod.
100	2.35 m	Black plastic/Czarny plastik	1 KIT/Zestaw	8952417
150	2.35 m	Black plastic/Czarny plastik	1 KIT/Zestaw	8952517

Plastic/Plastik

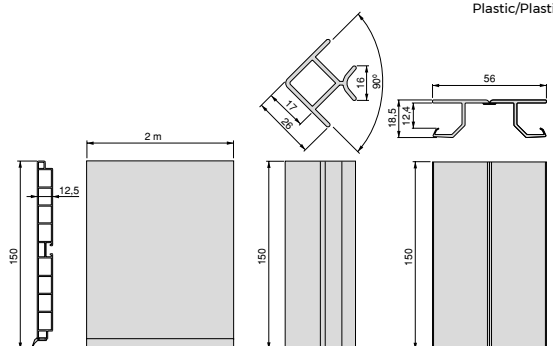
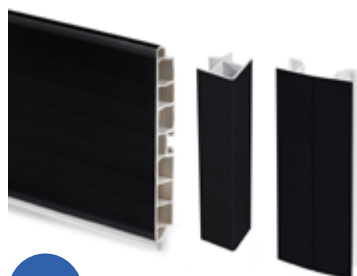

Suspended high module hanger
Wieszaki do modułów wysokich



Holdy hanger for high units
 Zawieszka typu Holdy



Description/Opis	Hand/Uchwyty	Finishing/Wykończenie	Packaging/Opakowanie	Cod.
Screw-on/Przykręcane	Right/Prawy	Zinc plated/Cynkowane	200 Unit/Szt	4342405
Screw-on/Przykręcane	Left/Lewy	Zinc plated/Cynkowane	200 Unit/Szt	4342505

Steel/Stal

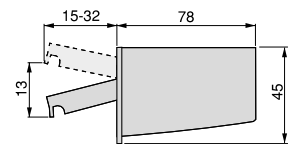
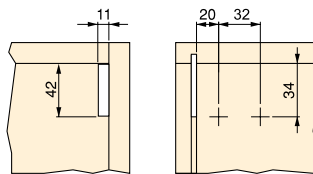

Holdy covers
 Zaślepki do zawieszek Holdy



Hand/Uchwyty	Finishing/Wykończenie	Packaging/Opakowanie	Cod.
Right/Prawy	Anthracite grey plastic/Szaro-antracytowy plastik	400 Unit/Szt	4342823
Left/Lewy	Anthracite grey plastic/Szaro-antracytowy plastik	400 Unit/Szt	4342923

Plastic/Plastik

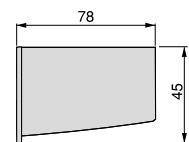

Hook hanger for high units
 Zawieszka wbijana Hook



Description/Opis	Hand/Uchwyty	Finishing/Wykończenie	Packaging/Opakowanie	Cod.
Screw-on/Przykręcane	Right/Prawy	Grey plastic/Szary plastik	200 Unit/Szt	8921621
Screw-on/Przykręcane	Left/Lewy	Grey plastic/Szary plastik	200 Unit/Szt	8921521
Knock-in/Wciskane	Right/Prawy	Grey plastic/Szary plastik	200 Unit/Szt	8921421
Knock-in/Wciskane	Left/Lewy	Grey plastic/Szary plastik	200 Unit/Szt	8921321

Plastic, Steel/Plastik, Stal

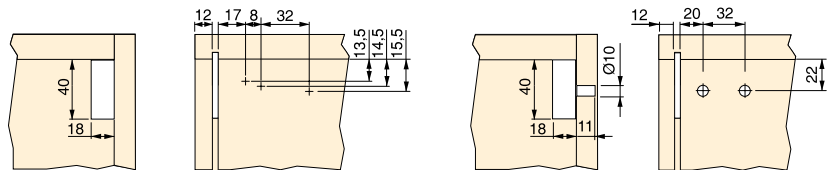
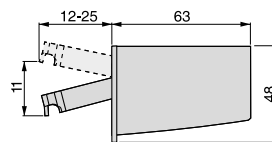

Hook covers
 Zaślepki do zawieszek Hook

Hand/Uchwyty	Finishing/Wykończenie	Packaging/Opakowanie	Cod.
Right/Prawy	Anthracite grey/Szary antracyt	200 Unit/Szt	8921835
Left/Lewy	Anthracite grey/Szary antracyt	200 Unit/Szt	8921735

Plastic/Plastik

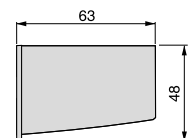

Inserts Ø20 for UniBlock coupling
 Wstawka Ø20 do zaczepu klinowego UniBlock

Board thickness/Grubość płyty	Y	Finishing/Wykończenie	Packaging/Opakowanie	Cod.
16-19	13	Grey plastic/Szary plastik	2500 Unit/Szt	8175121
22-30	17.5	Grey plastic/Szary plastik	2500 Unit/Szt	8175621

Plastic, Zamak/Plastik, Znal

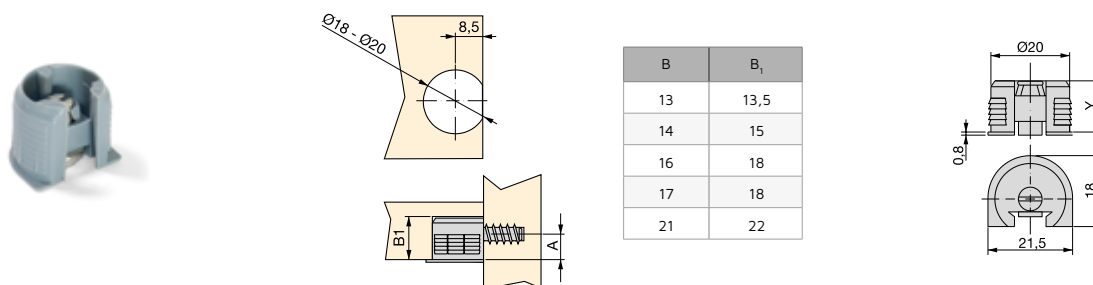

Supports for UniBlock coupling
 Wspornik do zaczepu klinowego Uniblock

A	B	Board thickness/Grubość płyty	Finishing/Wykończenie	Packaging/Opakowanie	Cod.
9.5	14	19	Black oxide/Czarny oksydowany	1250 Unit/Szt	8175953

Zamak/Znal



Ø7 screws
 Śruba Ø7

L	Finishing/Wykończenie	Packaging/Opakowanie	N° pieces/Liczba elementów	Cod.
50	Black zinc plated/Cynkowana czerni	2000 Unit/Szt	2000 units/2000 sztuk	7012109
60	Black zinc plated/Cynkowana czerni	1000 Unit/Szt	1000 units/1000 sztuk	7050709
70	Black zinc plated/Cynkowana czerni	1000 Unit/Szt	1000 units/1000 sztuk	7013809

Steel/Stal

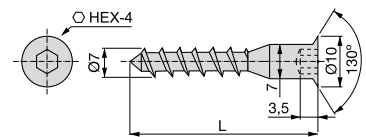

Ø5 screws
 Śruba Ø5

L	Finishing/Wykończenie	Packaging/Opakowanie	N° pieces/Liczba elementów	Cod.
50	Black zinc plated/Cynkowana czerni	3000 Unit/Szt	3000 units/3000 sztuk	7011909

Steel/Stal

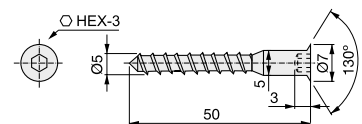

Bumpers Ø5 to be pressed in
Odbojniki Ø5 do wciśnięcia

Ø5

Finishing/Wykończenie	Packaging/Opakowanie	Cod.
Anthracite grey plastic/Szaro-antracytowy plastik 	2000 Unit/Szt	4014723



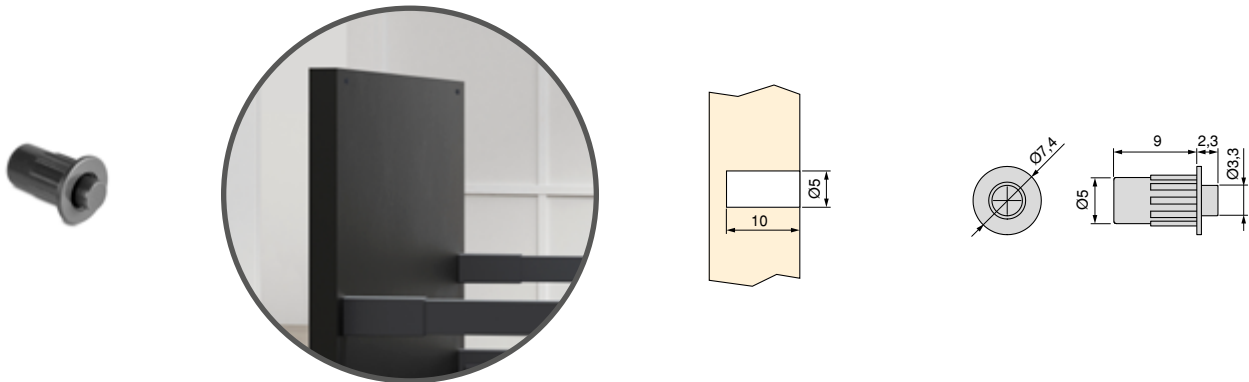

Plastic/Plastik



COVERCAPS / ZAŚLEPKI

Adhesive caps bumper
Odbojniki Zaślepka do przyklejenia



Diametre/Średnica	Finishing/Wykończenie	Packaging/Opakowanie	N° pieces/Liczba elementów	Cod.
13	Black plastic/Czarny plastik 	1000 Unit/Szt	20 units. / sheet/20 szt. / arkusz	5128917
20	Black plastic/Czarny plastik 	900 Unit/Szt	15 units. / sheet/15 szt. / arkusz	5136017
13	Anthracite grey plastic/Szaro-antracytowy plastik 	1000 Unit/Szt	20 units. / sheet/20 szt. / arkusz	5128923
20	Anthracite grey plastic/Szaro-antracytowy plastik 	900 Unit/Szt	15 units. / sheet/15 szt. / arkusz	5136023

Plastic/Plastik



Shelf brackets
Wsporniki do półek



Beak support for wooden shelf with bolt
Wspornik Beak do półki drewnianej z kołkami

Diametre/Średnica	Finishing/Wykończenie	Packaging/Opakowanie	Cod.
5	Black zinc plated/Cynkowana czerń 	1000 Unit/Szt	4015409

Zamak/Znal

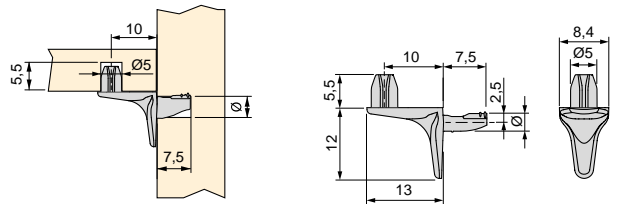

Shelf support Sekure
Wspornik Sekure ze sworzniem

Ø3 Ø5

Diametre/Średnica	Finishing/Wykończenie	Packaging/Opakowanie	Cod.
3	Anthracite grey plastic/Szaro-antracytowy plastik 	250 Unit/Szt	4008723
5	Anthracite grey plastic/Szaro-antracytowy plastik 	250 Unit/Szt	4008823

Plastic, Steel/Plastik, Stal

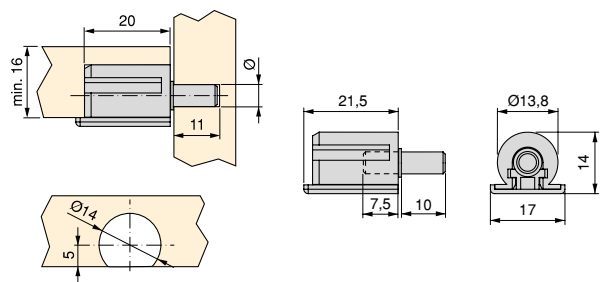

Beak support for glass shelf
Podpora Beak do półki szklanej

Diametre/Średnica	Finishing/Wykończenie	Packaging/Opakowanie	Cod.
5	Black zinc plated/Cynkowana czerń	1000 Unit/Szt	4015609

Zamak/Znal

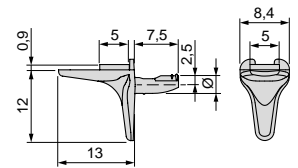
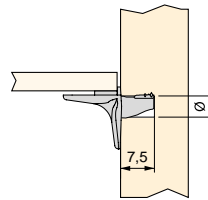

Portofino support for glass shelf
Podpora Portofino do półki szklanej

Ø5

Finishing/Wykończenie	Packaging/Opakowanie	Cod.
Black oxide/Czarny oksydowany	500 Unit/Szt	8194053

Plastic, Zamak/Plastik, Znal

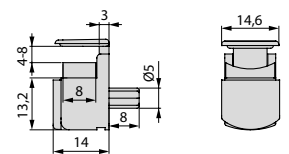
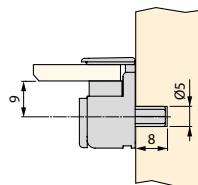

Evo bracket for glass shelf for bolt mounting

Uchwyt Evo do półki szklanej do montażu śrubowego

Ø3	Ø5	Diametre/Srednica	Finishing/Wykończenie	Packaging/Opakowanie	Cod.
		5	Black oxide/Czarny oksydowany	1000 Unit/Szt	4007953
Plastic, Zamak/Plastik, Znal					

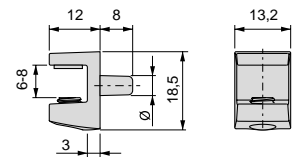
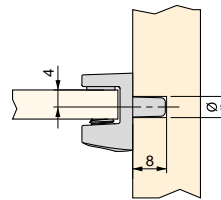

Evo support for glass shelf for screw mounting

Evo wspornik do półki szklanej do montażu śrubowego

Finishing/Wykończenie	Packaging/Opakowanie	Cod.
Black oxide/Czarny oksydowany	1000 Unit/Szt	4008053
Plastic, Zamak/Plastik, Znal		

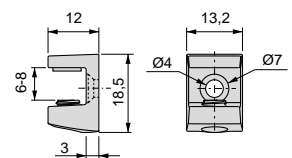
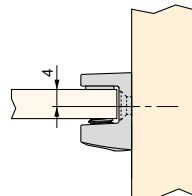

**Battery operated
Z baterią**



Kaus Black USB rechargeable LED wall light with motion sensor
Lampa ścienna LED Kaus Black ładowana przez USB z czujnikiem ruchu

IP20	CRI ≥80	LED	7 lx	150°	5V DC	2 m	120°	dimnable 10-100%	ON/OFF 18"	SENSOR MOTION	UK CA ICE	
L	Lumen	Power/Moc	Colour temperature/ Temperatura koloru	Finishing/Wykończenie	Packaging/Opakowanie	Cod.						
240	60 lm	1 W	Natural white 4,000 K/ Naturalna biel 4,000 K	Black painted/Malowane na czarno	1 Unit/Szt	5214114						
400	120 lm	2 W	Natural white 4,000 K/ Naturalna biel 4,000 K	Black painted/Malowane na czarno	1 Unit/Szt	5214214						
600	180 lm	3 W	Natural white 4,000 K/ Naturalna biel 4,000 K	Black painted/Malowane na czarno	1 Unit/Szt	5214314						

Aluminium, Plastic/Aluminium, Plastik

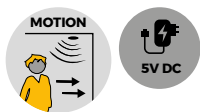

	240 mm	400 mm	600 mm
0,25 m	368 lx	610 lx	855 lx
0,50 m	105 lx	234 lx	286 lx
0,75 m	49 lx	117 lx	135 lx
1,00 m	28 lx	70 lx	78 lx
1,25 m	18 lx	45 lx	50 lx

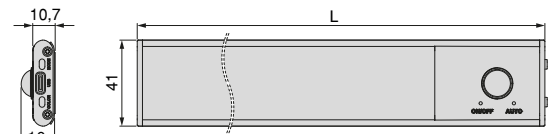

Kaus Black USB rechargeable LED wall light with proximity sensor
Kaus Czarna lampa ścienna LED ładowana przez USB z czujnikiem zbliżeniowym

IP20	CRI ≥80	LED	7 lx	150°	5V DC	7 cm	120°	dimnable 10-100%	SENSOR SWITCH	UK CA ICE	
L	Lumen	Power/Moc	Colour temperature/ Temperatura koloru	Finishing/Wykończenie	Packaging/Opakowanie	Cod.					
240	60 lm	1 W	Natural white 4,000 K/ Naturalna biel 4,000 K	Black painted/Malowane na czarno	1 Unit/Szt	5214414					
400	120 lm	2 W	Natural white 4,000 K/ Naturalna biel 4,000 K	Black painted/Malowane na czarno	1 Unit/Szt	5214514					
600	180 lm	3 W	Natural white 4,000 K/ Naturalna biel 4,000 K	Black painted/Malowane na czarno	1 Unit/Szt	5214614					

Aluminium, Plastic/Aluminium, Plastik

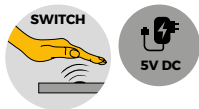

	240 mm	400 mm	600 mm
0,25 m	368 lx	610 lx	855 lx
0,50 m	105 lx	234 lx	286 lx
0,75 m	49 lx	117 lx	135 lx
1,00 m	28 lx	70 lx	78 lx
1,25 m	18 lx	45 lx	50 lx

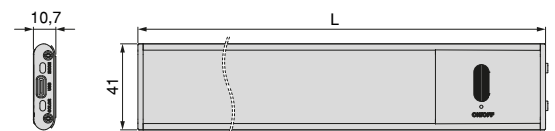

Illuminated mirrors
Podświetlane lustra



Cepheus mirror with LED decorative lighting (AC 230V 50Hz)

Lustro Cepheus z ozdobnym oświetleniem LED (AC 230V 50Hz)

IP44	silicone	F	1 m	CRI ≥80	LED		120°		~AC 230V 50Hz					
Lumen	Power/Moc	Colour temperature/ Temperatura koloru		LEDs	Finishing/Wykończenie		Packaging/Opakowanie		Cod.					
882 lm	12 W	Natural white 4.000 K/ Naturalna biel 4.000 K		129	Not defined/ Nieokreślone			1 Unit/Szt	5150920					

Aluminium, Glass/Aluminium, Szkło



Mirror with integrated LED backlighting that can be installed both vertically and horizontally.

Lustro ze zintegrowanym podświetleniem LED, które można zamontować zarówno pionowo, jak i poziomo.

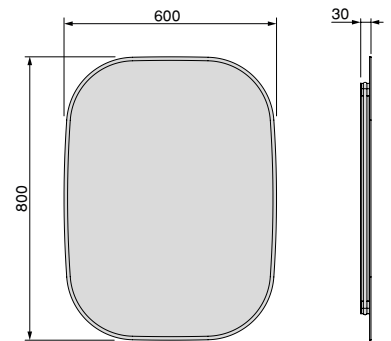

Zeus mirror with LED decorative lighting (AC 230V 50Hz)

Lustro Zeus z ozdobnym oświetleniem LED (AC 230V 50Hz)

IP44	silicone	F	1 m	CRI ≥80	LED		120°		~AC 230V 50Hz					
Lumen	Power/Moc	Colour temperature/ Temperatura koloru		LEDs	Finishing/Wykończenie		Packaging/Opakowanie		Cod.					
850 lm	12 W	Natural white 4.000 K/ Naturalna biel 4.000 K		126	Not defined/ Nieokreślone			1 Unit/Szt	5150820					

Aluminium, Glass/Aluminium, Szkło

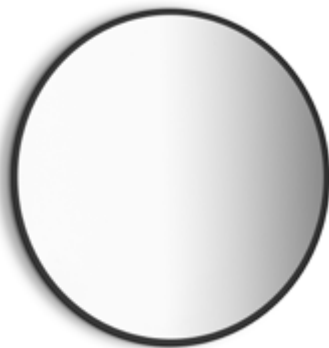

Mirror with integrated LED backlight.

Lustro ze zintegrowanym podświetleniem LED.

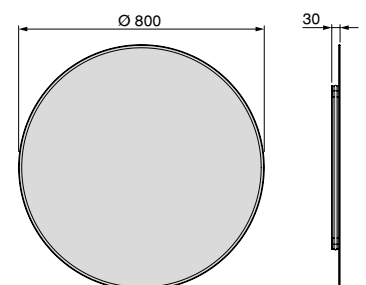

Bathroom lights
Oświetlenie łazienkowe



Leo LED bathroom mirror spotlight (AC 230V 50Hz)
Reflektor LED do lustra łazienkowego Leo (AC 230V 50Hz)



Lumen	Power/Moc	Colour temperature/ Temperatura koloru	LEDs	Finishing/Wykończenie	Packaging/Opakowanie	Cod.
457 lm	6 W	Cold white 5.700 K/ Zimna biel 5.700 K	60	Black painted/Malowane na czarno	5 Unit/Szt	5150114

Plastic/Plastik

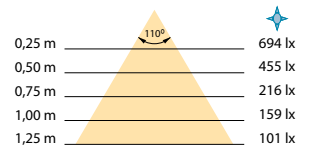
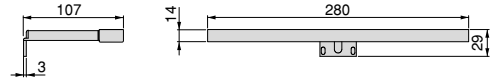

Virgo LED bathroom mirror spotlight (AC 230V 50Hz)
Reflektor LED do lustra łazienkowego Virgo (AC 230V 50Hz)

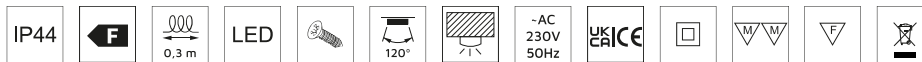

Lumen	Power/Moc	Colour temperature/ Temperatura koloru	LEDs	Finishing/Wykończenie	Packaging/Opakowanie	Cod.
400 lm	6 W	Cold white 6.000 K/ Zimna biel 6.000 K	60	Black painted/Malowane na czarno	5 Unit/Szt	5149114

Plastic/Plastik

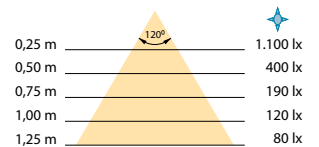
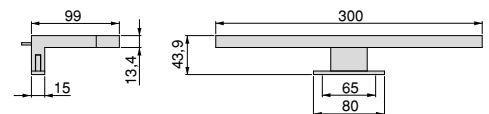
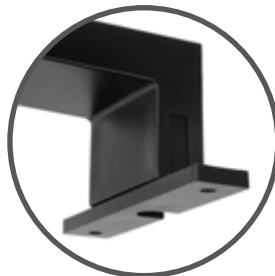

Gemini LED bathroom mirror spotlight (AC 230V 50Hz)

Reflektor LED do lustra łazienkowego Gemini (AC 230V 50Hz)



Lumen	Power/Moc	Colour temperature/ Temperatura koloru	Finishing/Wykończenie	Packaging/Opakowanie	Cod.
392 lm	6 W	Natural white 4.000 K/ Naturalna biel 4.000 K	Black painted/Malowane na czarno	5 Unit/Szt	5150014

Aluminium, Plastic/Aluminium, Plastik

AC 230V 50Hz IP44

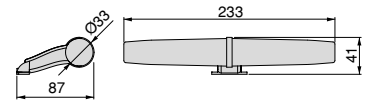
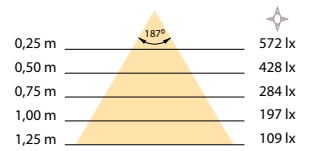

They stand out for their easy installation as they include all the necessary elements for assembly.

Wyróżniają się łatwą instalacją, ponieważ zawierają wszystkie elementy niezbędne do montażu.

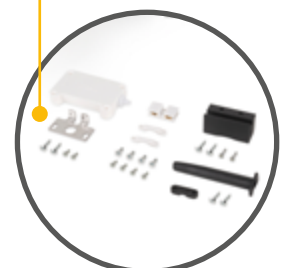

LED spotlight Crux-in-Q (AC 230V 50Hz)
Światło LED Crux-in-Q (AC 230V 50Hz)

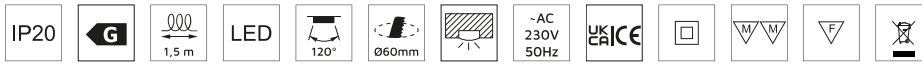

Lumen	Power/Moc	Colour temperature/ Temperatura koloru	LEDs	Finishing/Wykończenie	Packaging/Opakowanie	Cod.
101 lm	1,8 W	Natural white 4.000 K/ Naturalna biel 4.000 K	24	Black painted/Malowane na czarno	6 Unit/Szt	5203914

Plastic/Plastik

AC 230V
50Hz

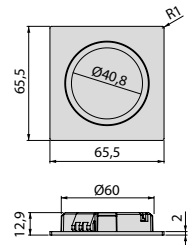
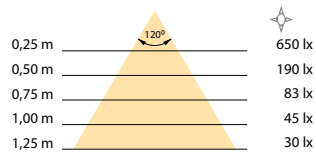
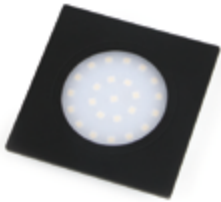

Lights
Kinkiety



Flexible Alioth LED luminaire with USB-A 5V DC-1A Max. charging port (12V DC)
Elastyczna oprawa LED Alioth z portem ładowania USB-A 5V DC-1A maks. (12V DC)

IP20	G	1.9 m	LED	180°	AMP & MINILED	SENSOR SWITCH	UKRAINE	CE	M/M	F	12V DC	
Lumen	Power/Moc	Colour temperature/Temperatur koloru	Input	Output	Finishing/Wykończenie	Packaging/Opakowanie	Cod.					
68 lm	1,2 W	Natural white 4,000 K/Naturalna biel 4,000 K	12V DC Min 15W/12V DC Min 15W	5V DC 1A Max./5V DC 1A Max.	Black painted/Malowane na czarno	1 Unit/Szt	5218114					

Plastic/Plastik

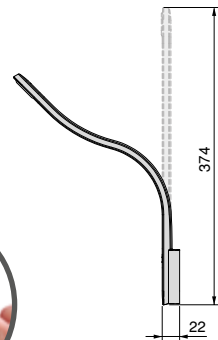
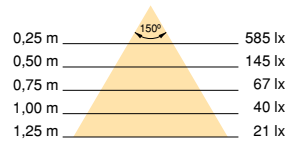
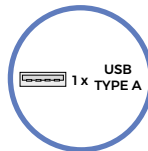

Flexible Algol LED luminaire with USB-A 5V DC-1A Max. charging port (12V DC)
Elastyczna oprawa LED Algol z portem ładowania USB-A 5V DC-1A maks. (12V DC)

IP20	G	1.9 m	LED	180°	AMP & MINILED	SENSOR SWITCH	UKRAINE	CE	M/M	F	12V DC	
Lumen	Power/Moc	Colour temperature/Temperatur koloru	Input	Output	Finishing/Wykończenie	Packaging/Opakowanie	Cod.					
93 lm	1,8 W	Natural white 4,000 K/Naturalna biel 4,000 K	12V DC Min 15W/12V DC Min 15W	5V DC 1A Max./5V DC 1A Max.	Black painted/Malowane na czarno	1 Unit/Szt	5218214					

Plastic/Plastik

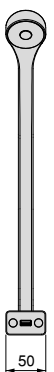
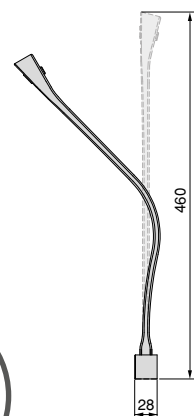
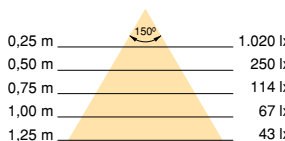
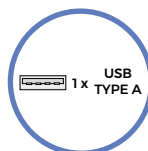

Constant-voltage converter for LED lights, plastic (12V DC)
Zasilacz napięcia stałego do opraw LED, plastik (12V DC)

A	B	C	Power/Moc	Input	Output	Finishing/Wykończenie	Packaging/Opakowanie	Cod.
16.2	96	41	6 W	180-240V AC - 50Hz/180-240V AC - 50Hz	12V DC	Not defined/ Nieokreślone	10 Unit/Szt	5211020
16.2	96	41	15 W	180-240V AC - 50Hz/180-240V AC - 50Hz	12V DC	Not defined/ Nieokreślone	10 Unit/Szt	5211120
17	164	65	30 W	100-240V AC - 50-60Hz	12V DC	Not defined/ Nieokreślone	10 Unit/Szt	5147420
17	164	65	50 W	100-240V AC - 50-60Hz	12V DC	Not defined/ Nieokreślone	10 Unit/Szt	5147520
38	153	60	72 W	100-240V AC - 50-60Hz	12V DC	Not defined/ Nieokreślone	10 Unit/Szt	5008520

Plastic/Plastik

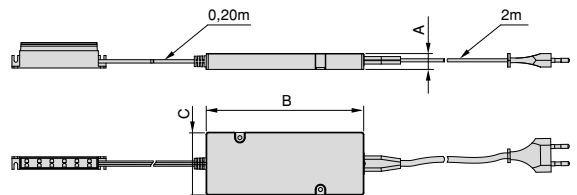

Constant-voltage converter for LED lights (12V DC)
Zasilacz napięcia stałego do opraw LED (12V DC)

A	B	C	Power/Moc	Input	Output	Finishing/Wykończenie	Packaging/Opakowanie	Cod.
18	160	58	100 W	200-240V AC - 50-60Hz	12V DC	Not defined/ Nieokreślone	5 Unit/Szt	5209320
35	205	71	200 W	200-240V AC - 50-60Hz	12V DC	Not defined/ Nieokreślone	5 Unit/Szt	5209420

Aluminium, Steel/Aluminium, Stal

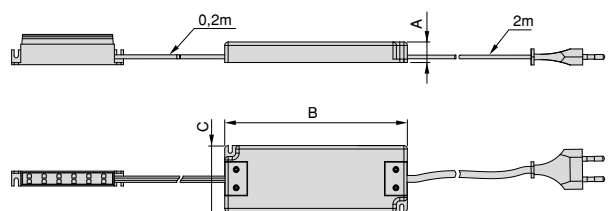

Constant-voltage converter for LED lights, plastic (24V DVC)
Zasilacz napięcia stałego do opraw LED, plastik (24V DVC)

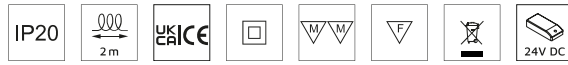

A	B	C	Power/Moc	Input	Output	Finishing/Wykończenie	Packaging/Opakowanie	Cod.
16.2	96	41	15 W	180-240V AC - 50Hz/180-240V AC - 50Hz	24V DC/24V DC	Not defined/ Nieokreślone	<input type="checkbox"/>	10 Unit/Szt 5211220
17	164	65	30 W	100-240V AC - 50-60Hz	24V DC/24V DC	Not defined/ Nieokreślone	<input type="checkbox"/>	10 Unit/Szt 5147620
17	164	65	50 W	100-240V AC - 50-60Hz	24V DC/24V DC	Not defined/ Nieokreślone	<input type="checkbox"/>	10 Unit/Szt 5147720

Aluminium, Steel/Aluminium, Stal

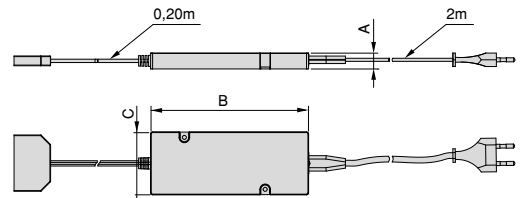
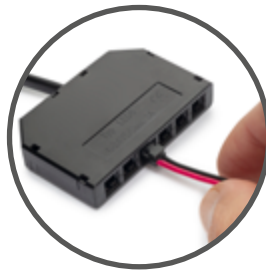

Constant-voltage converter for LED lights (24V DC)
Zasilacz napięcia stałego do opraw LED (24V DC)



A	B	C	Power/Moc	Input	Output	Finishing/Wykończenie	Packaging/Opakowanie	Cod.
18	160	58	100 W	200-240V AC - 50-60Hz	24V DC/24V DC	Not defined/ Nieokreślone	<input type="checkbox"/>	5 Unit/Szt 5209520

Aluminium, Steel/Aluminium, Stal

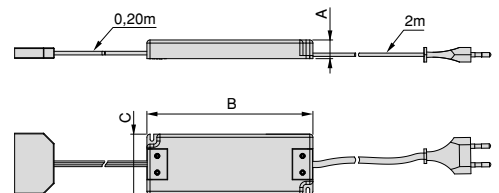

Receptor of LED sensor Wirly 12V DC / 24V DC
Odbiornik czujnika LED Wirly 12V DC / 24V DC

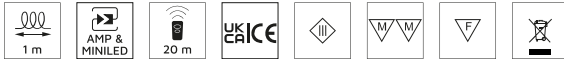

Power/Moc	Input	Output	Finishing/Wykończenie	Packaging/Opakowanie	Cod.
36 W (12V DC) - 72 W (24V DC)	12V DC - 24V DC	12V DC - 24V DC	Not defined/Nieokreślone	10 Unit/Szt	5215020

Plastic/Plastik

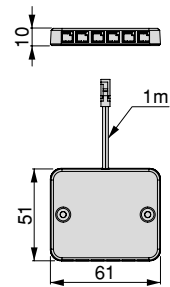
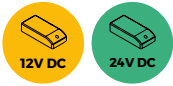

One transmitter can be linked to up to 8 receivers and one receiver can be linked to up to 10 different transmitters.

Jeden nadajnik może być połączony z maksymalnie 8 odbiornikami, a jeden odbiornik może być połączony z maksymalnie 10 różnymi nadajnikami.

The Wirly detection system consists of a receiver and a signal transmitter that allows the luminaires to be switched on and off from any point via radio frequency.

System detekcji Wirly składa się z odbiornika i nadajnika sygnału, który umożliwia włączanie i wyłączenie opraw z dowolnego miejsca za pośrednictwem częstotliwości radiowej.

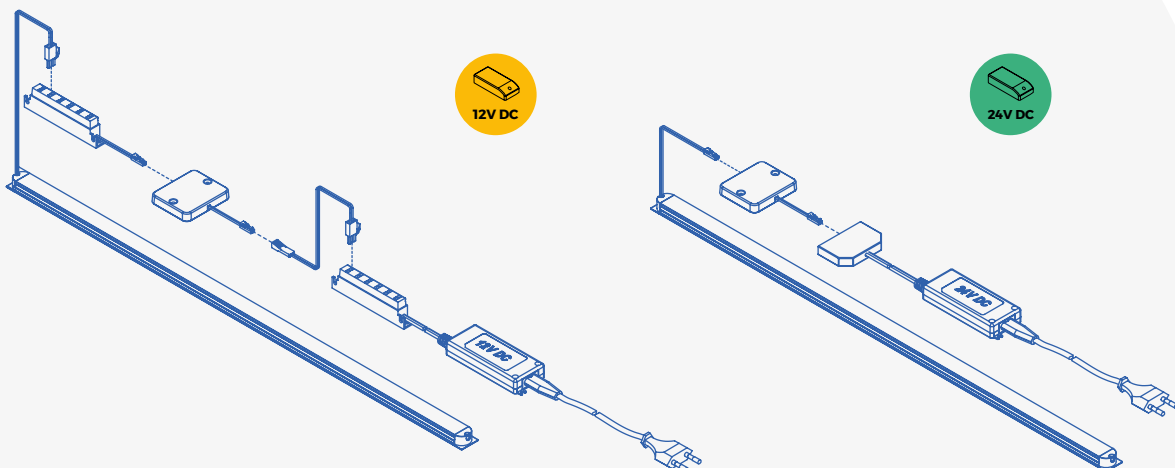

Transmitter for LED sensor Wirly switch/dimmer (switch) 12V DC / 24V DC
Nadajnik zbliżeniowy LED Wirly switch/dimmer (przełącznik) 12V DC / 24V DC



Model/Model	Finishing/Wykończenie	Packaging/Opakowanie	Cod.
SWITCH DIMMER SIMPLE	Not defined/Nieokreślone <input type="checkbox"/>	10 Unit/Szt	5215120

Plastic/Plastik

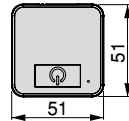
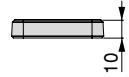
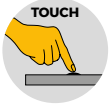

Transmitter for LED sensor Wirly switch/motion (movement) 12V DC / 24V DC
Nadajnik zbliżeniowy LED Wirly switch/motion (ruch) 12V DC / 24V DC



Model/Model	Finishing/Wykończenie	Packaging/Opakowanie	Cod.
MOTION SIMPLE	Not defined/Nieokreślone <input type="checkbox"/>	10 Unit/Szt	5215220

Plastic/Plastik

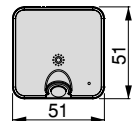
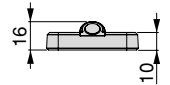

Transmitter for LED sensor Wirly door (proximity) 12V DC / 24V DC
Nadajnik zbliżeniowy LED Wirly door (zbliżeniowy) 12V DC / 24V DC



Model/Model	Finishing/Wykończenie	Packaging/Opakowanie	Cod.
DOOR SIMPLE / DOOR DOBLE / PROXIMITY DIMMER	Not defined/Nieokreślone <input type="checkbox"/>	10 Unit/Szt	5215320

Plastic/Plastik

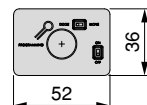
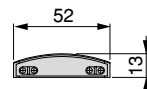
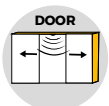

LED sensor Spirit switch/dimmer (switch) hidden sensor 12V DC
Czujnik LED Włącznik/ściemniacz (Włącznik) ukryty czujnik Spirit



Model/Model	Power/Moc	Input	Output	Finishing/Wykończenie	Packaging/Opakowanie	Cod.
SWITCH DIMMER SIMPLE	Max. 80 W	12V DC	12V DC	Black plastic/Czarny plastik	6 Unit/Szt	5022617

Plastic/Plastik

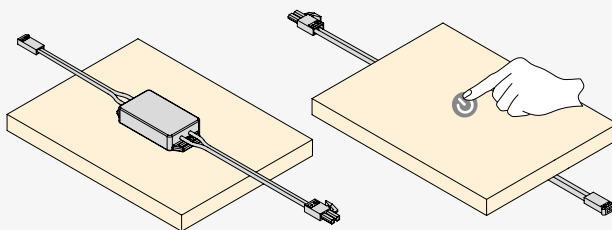
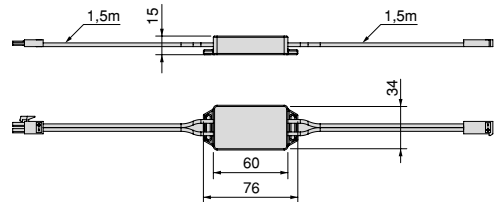
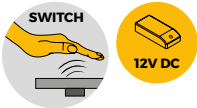

Hidden sensor that penetrates materials of up to 32 mm thick. Not compatible with mirrors and metals.

- E < 32 mm Wood.
- E < 22 mm Plastic.
- E < 20 mm Stone.
- E < 12 mm Glass.

Ukryty czujnik przenikający materiały o grubości do 32 mm. Niekompatybilne z lustrami.

- E < 32 mm Drewno.
- E < 22 mm Plastik.
- E < 20 mm Kamień.
- E < 12 mm Kamień.



Wardrobe door switch
Przełącznik do drzwi szafy



Finishing/Wykończenie	Packaging/Opakowanie	Cod.
Black plastic/Czarny plastik	10 Unit/Szt	9642417

Plastic/Plastik

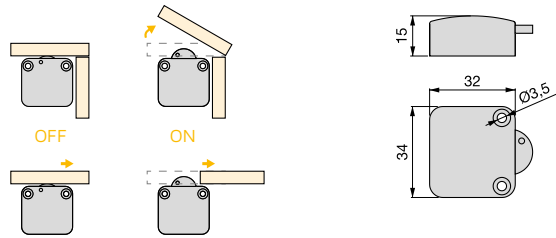

Switch for embedding D21x21
Włącznik, montaż wpuszczany D21x21



Finishing/Wykończenie	Packaging/Opakowanie	Cod.
Black plastic/Czarny plastik	10 Unit/Szt	9640217

Plastic/Plastik

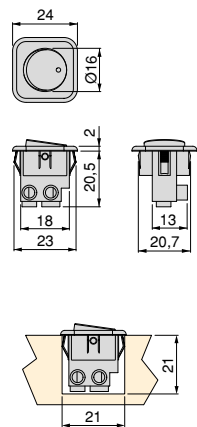

Profiles Lynx
Profile Lynx



Lynx W diffuser profile for LED strip
 Profil rozpraszający Lynx W do taśmy LED



Longitude/Długość	Finishing/Wykończenie	Packaging/Opakowanie	Cod.
2,35 m	Black plastic/Czarny plastik	20 Unit/Szt	5147817

Plastic/Plastik

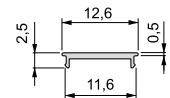
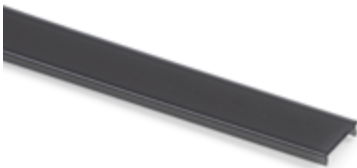

Profile Lynx W for recessed installation for LED strip
 Profil Lynx W do montażu wpuszczanego na taśmę LED



Longitude/Długość	Finishing/Wykończenie	Packaging/Opakowanie	Cod.
2,35 m	Black anodized/Czarny anodowany	20 Unit/Szt	5147967

Aluminium/Aluminium

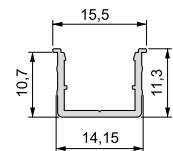

Accessory for recessed installation in aluminum Lynx W profile
 Akcesoria do montażu wpuszczanego w profilu aluminiowym Lynx W.



Finishing/Wykończenie	Packaging/Opakowanie	Cod.
Black plastic/Czarny plastik	20 Unit/Szt	5148417

Plastic/Plastik

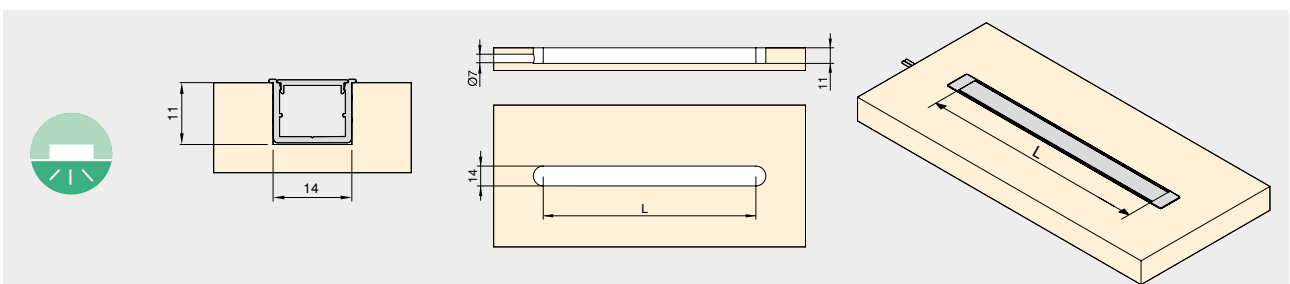
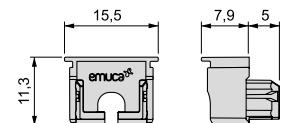

Lynx W diffuser profile for LED strip
Profil rozpraszający Lynx W do taśmy LED



Longitude/Długość	Finishing/Wykończenie	Packaging/Opakowanie	Cod.
2,35 m	Black plastic/Czarny plastik	20 Unit/Szt	5147817

Plastic/Plastik

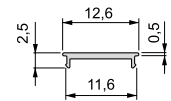
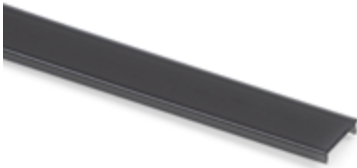

Surfacemount Lynx W profile for LED strip
Profil Surfacemount Lynx W do taśmy LED



Longitude/Długość	Finishing/Wykończenie	Packaging/Opakowanie	Cod.
2,35 m	Black anodized/Czarny anodowany	20 Unit/Szt	5148067

Aluminium/Aluminium

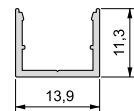
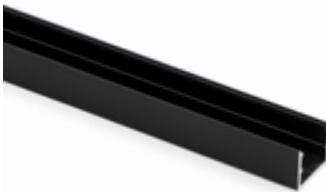

Accessories for surfacemount Lynx W profile
Akcesoria do profilu powierzchniowego Lynx W.



Finishing/Wykończenie	Packaging/Opakowanie	Cod.
Black plastic/Czarny plastik	10 Unit/Szt	5148517

Plastic/Plastik

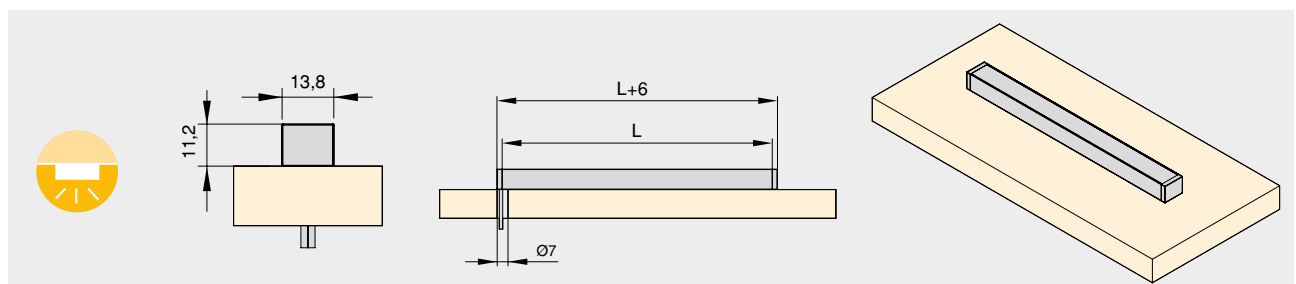
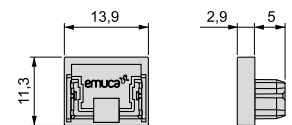

Profiles Lynx W for recessed installation for LED strip
 Profile Lynx W do montażu podtynkowego do taśm LED



Longitude/Długość	Finishing/Wykończenie	Packaging/Opakowanie	Cod.
2,35 m	Black anodized/Czarny anodowany	8 Unit/Szt	5148967

Aluminium/Aluminium

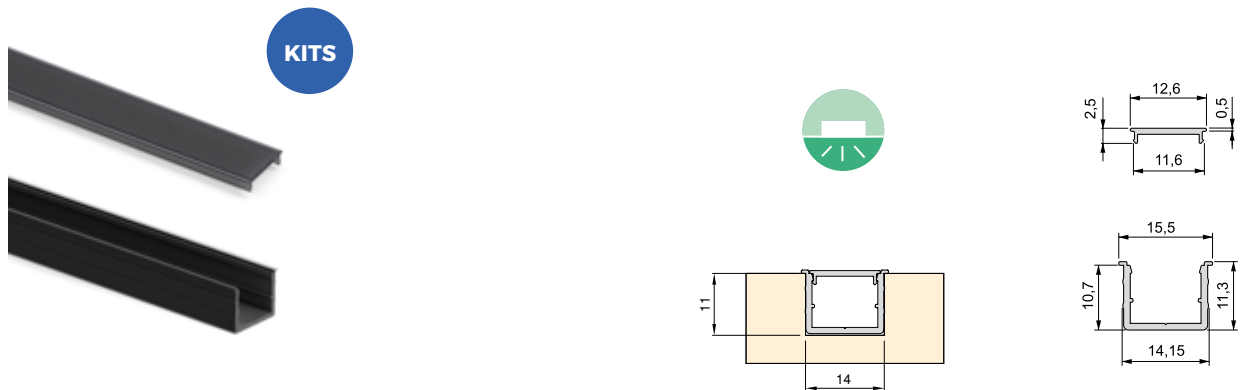

Surfacemount Lynx W profiles for LED strip
 Profile Surfacemount Lynx W do taśm LED



Longitude/Długość	Finishing/Wykończenie	Packaging/Opakowanie	Cod.
2,35 m	Black anodized/Czarny anodowany	8 Unit/Szt	5149067

Aluminium/Aluminium

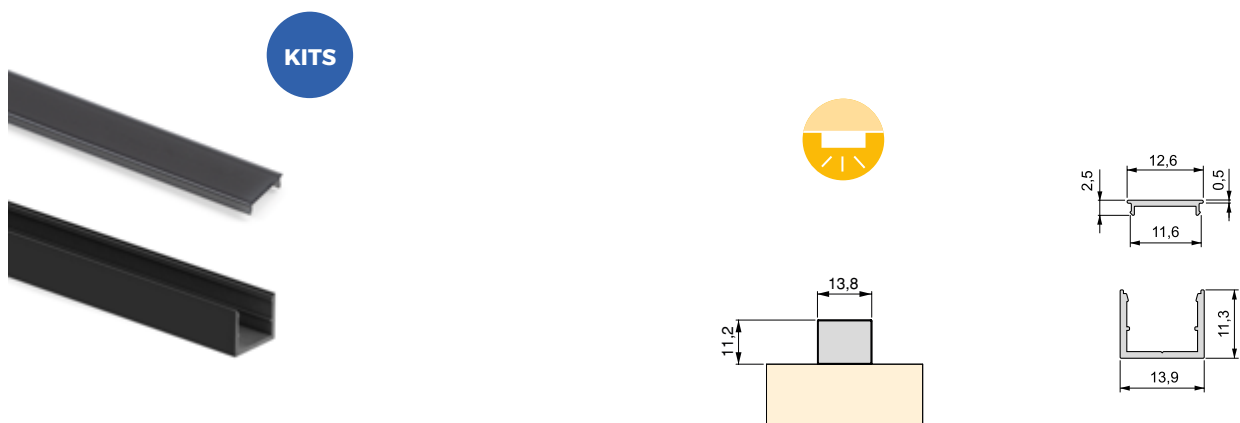

Chargers Ładowarki



Airtop 2 wireless hidden charger for mobiles (Ø60mm)
Bezprzewodowa ładowarka ukryta do telefonów komórkowych Airtop (Ø60mm)

Input	Output	Finishing/Wykończenie			Packaging/Opakowanie	Cod.			
100-240V AC - 50/60Hz	5V DC 2A (Qi-10W)	Black plastic/Czarny plastik			1 Unit/Szt	5049317			

Plastic/Plastik

AC 230V
50Hz

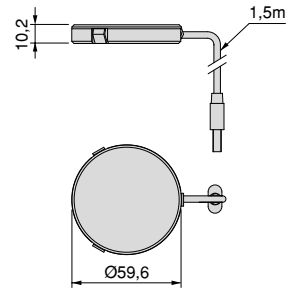
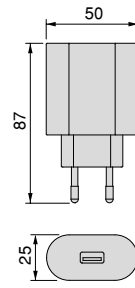
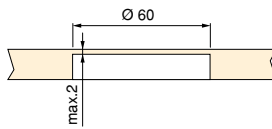

Airtop 2 USB-A wireless charger of surface for mobiles (Ø60mm)
Bezprzewodowa ładowarka Surface Airtop 2 USB-A (Ø60 mm)

Input	Output	Finishing/Wykończenie			Packaging/Opakowanie	Cod.			
100-240V AC - 50/60Hz	5V DC / 2.1A (USB-10W/Qi-10W)	Black plastic/Czarny plastik			1 Unit/Szt	5049217			

Plastic/Plastik

AC 230V
50Hz

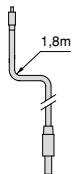
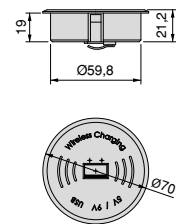
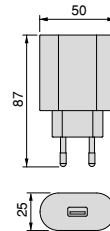
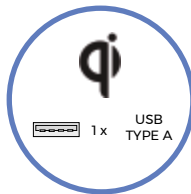
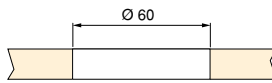

Connectors
Złącza



Linky USB A+C charger (81x12mm)
USB A+C Linky złącze (81x12mm)

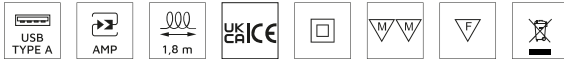

Input	Output	Finishing/Wykończenie	Packaging/Opakowanie	Cod.
100-240V AC - 50/60Hz/100-240V AC - 50/60Hz	5V/9V DC 3A (15W)/5V/9V DC 3A (15W)	Black plastic/Czarny plastik	1 Unit/Szt	5049417

Plastic/Plastik

AC 230V
50Hz

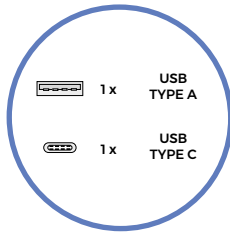
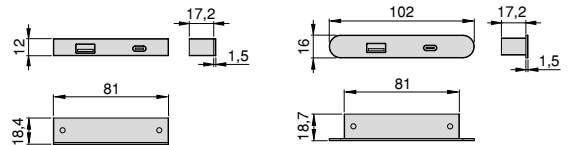

Circle 80 plug connector and grommet (Ø80mm)
Złącze i przelotka Circle 80 (Ø80mm)



Power/Moc	Finishing/Wykończenie	Packaging/Opakowanie	Cod.
USB A - DC 5V-2.1A (10.5W) - USB C - DC 5V-2.1A (10.5W)	Black painted/Malowane na czarno	1 Unit/Szt	5048414

Plastic/Plastik

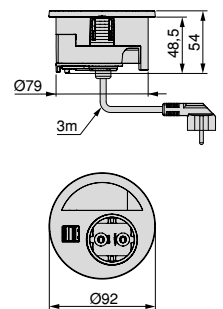
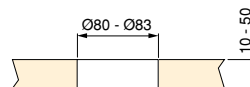
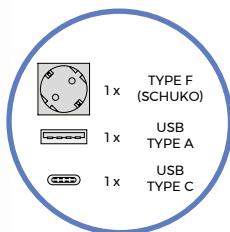

Plugy USB A+C charger Ø37 (Ø25mm)

USB A+C Plugy złącze okrągłe Ø37 (Ø25mm)

Description/Opis	Input	Output	Finishing/Wykończenie	Packaging/Opakowanie	Cod.					
Ø37	12VDC-2.5A (30W) / 24VDC-1.5A (36W)	USB-A 18W: 5V-3A / 10V-2.22A / 12V-1.67A USB-C 20W: 5V-3A / 9V-2.22A / 12V-1.67A	Black painted/Malowane na czarno		6 Unit/Szt	5221114				

Plastic/Plastik

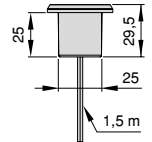
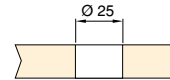
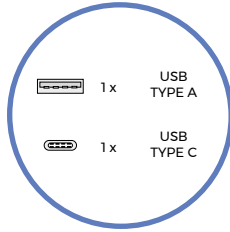

USB Plugy Ø37 round charger (Ø25mm)

USB Plugy złącze okrągłe Ø37 (Ø25mm)

Description/Opis	Input	Output	Finishing/Wykończenie	Packaging/Opakowanie	Cod.					
Ø37	12V DC	5V DC	Black painted/Malowane na czarno		6 Unit/Szt	5009014				

Plastic/Plastik

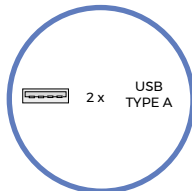

	Input	Output
	30 W 12V DC (2,50A)	5V DC - 3,40A MAX. (1 x 3,40A) (2 x 1,70A)
	15 W 12V DC (1,25A)	5V DC - 1,70A MAX. (1 x 1,70A) (2 x 0,85A)

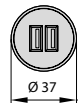
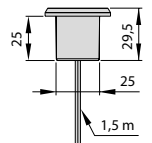
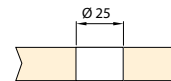

Plugy round charger with 2 USB ports for embedding into furniture (Ø25mm)

Ładowarka 2x USB wpuszczana w płytę meblową. Plugy (Ø25mm)

Description/Opis	Finishing/Wykończenie	Packaging/Opakowanie	Cod.						
Ø37	Black painted/Malowane na czarno		1 KIT/Zestaw	5070614					



Plastic/Plastik

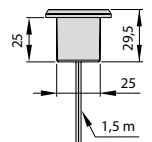
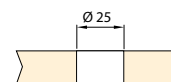
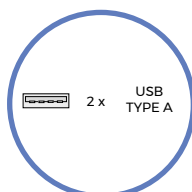

Connector One for embedding into furniture (Ø54mm)
Conector One montaż wpuszczany wewnątrz mebla (Ø54mm)

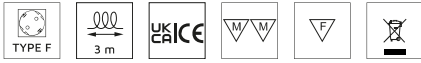

Description/Opis	Power/Moc	Finishing/Wykończenie	Packaging/Opakowanie	Cod.
Black painted/Malowane na czarno		■	1 Unit/Szt	5048314

Plastic/Plastik

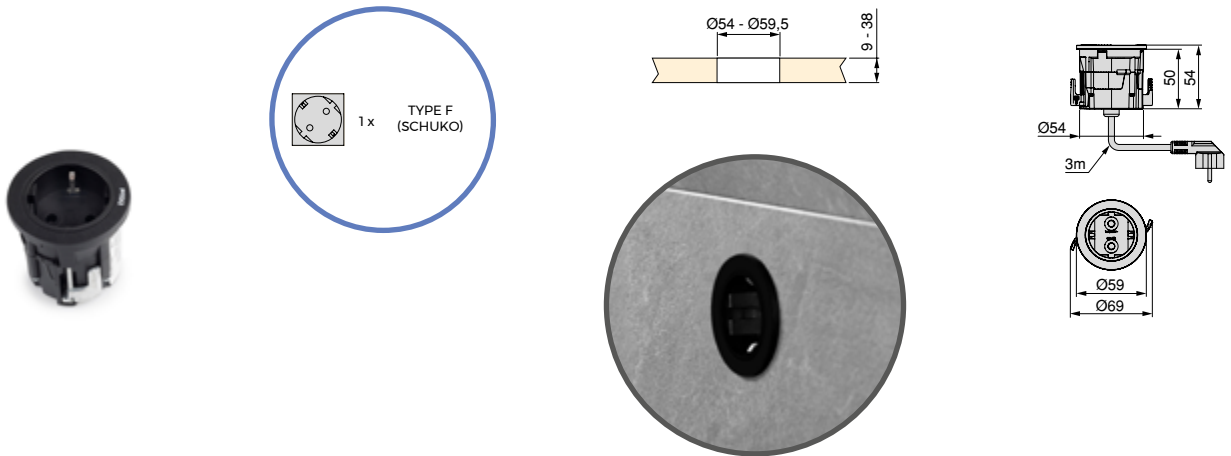

Vertikal retractable multi-plug connector (Ø60mm)
Gniazdowa listwa zasilająca wysuwana Vertikal (Ø60mm)



Description/Opis	Power/Moc	Finishing/Wykończenie	Packaging/Opakowanie	Cod.	
3 plugs and 2 USB connectors/3 wtyczki i 2 złącza USB	USB A - DC 5V-2A (10W)	Black painted/Malowane na czarno	■	1 Unit/Szt	5009914

Aluminium, Plastic/Aluminium, Plastik

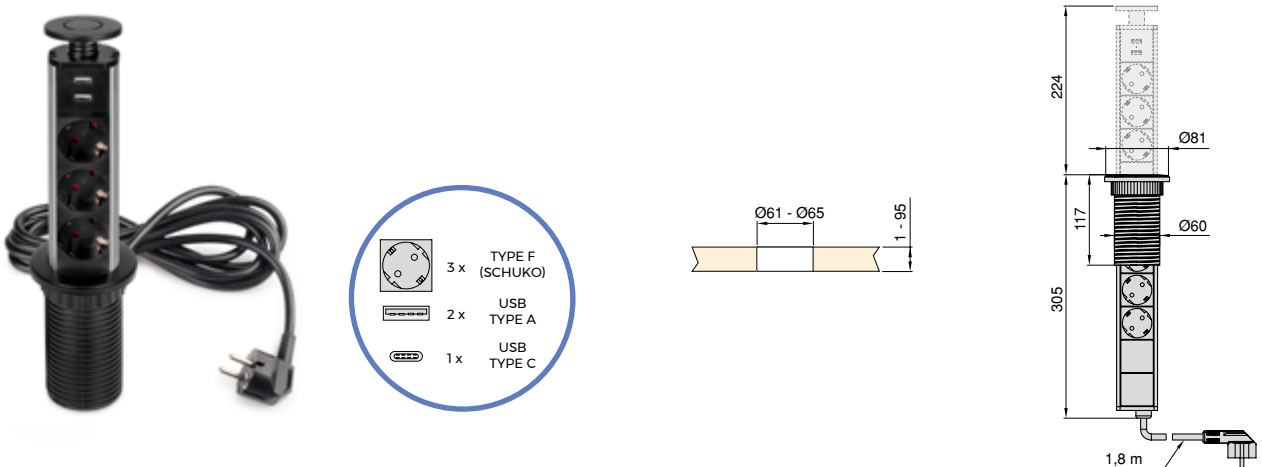

Atom 14 Multi-plug connector for desk (130x115mm)
Wielozłącze Atom 14 na biurko (130x115mm)



Power/Moc	Finishing/Wykończenie	Packaging/Opakowanie	Cod.
USB A - DC 5V-2.1A (10.5W)	Black painted/Malowane na czarno	1 Unit/Szt	5029714

Aluminium, Plastic, Steel/Aluminium, Plastik, Stal

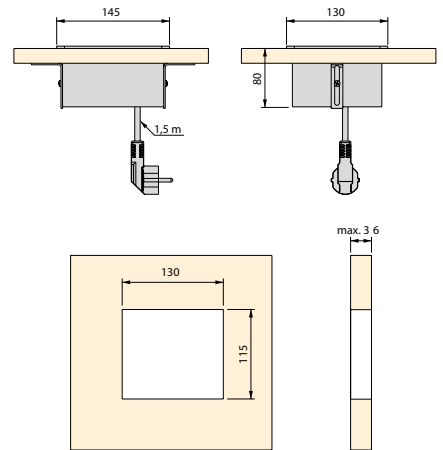
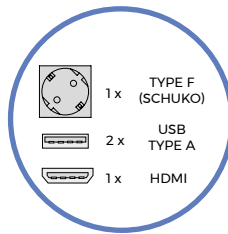

Vertikal Push 100 plug connector (Ø100mm)
Listwa zasilająca z gniaздkami Vertikal Push 100 (Ø100mm)



Power/Moc	Finishing/Wykończenie	Packaging/Opakowanie	Cod.
USB A - DC 5V-2.4A (12W)	Black painted/Malowane na czarno	1 Unit/Szt	5048214

Plastic, Steel/Plastik, Stal

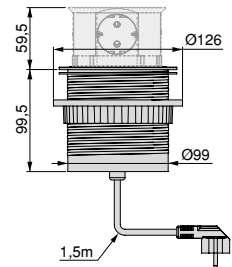
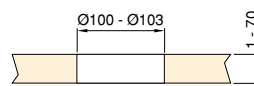
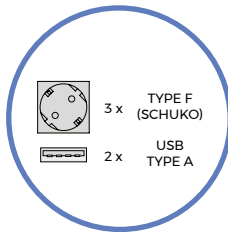

Atom 26 Multi-plug connector for desk (225x111mm)
Wielozłącze Atom 26 na biurko (225x111mm)

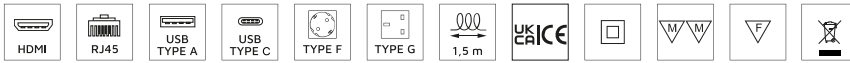

Power/Moc	Finishing/Wykończenie	Packaging/Opakowanie	Cod.
USB A - DC 5V-3A / 9V-2A / 12V-1.5A - USB C - DC 5V-3A / 9V-2A / 12V-1.5A	Black painted/Malowane na czarno	1 UN/UN	5039914

Plastic, Steel, Zamak/Plastik, Stal, Znal

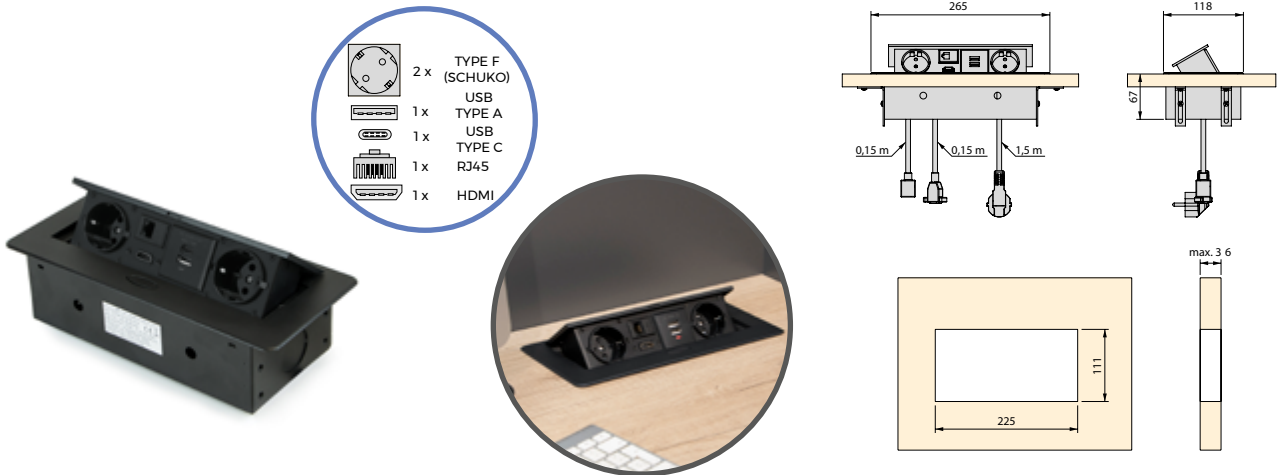

Atom 26 Lite Multi-plug connector for desk (225x111mm)
Wielozłącze Atom 26 Lite na biurko (225x111mm)



Power/Moc	Finishing/Wykończenie	Packaging/Opakowanie	Cod.
USB A - DC 5V-2.1A (10.5W) - USB C - DC 5V-2.1A (10.5W)	Black painted/Malowane na czarno	1 Unit/Szt	5039814

Plastic, Steel, Zamak/Plastik, Stal, Znal

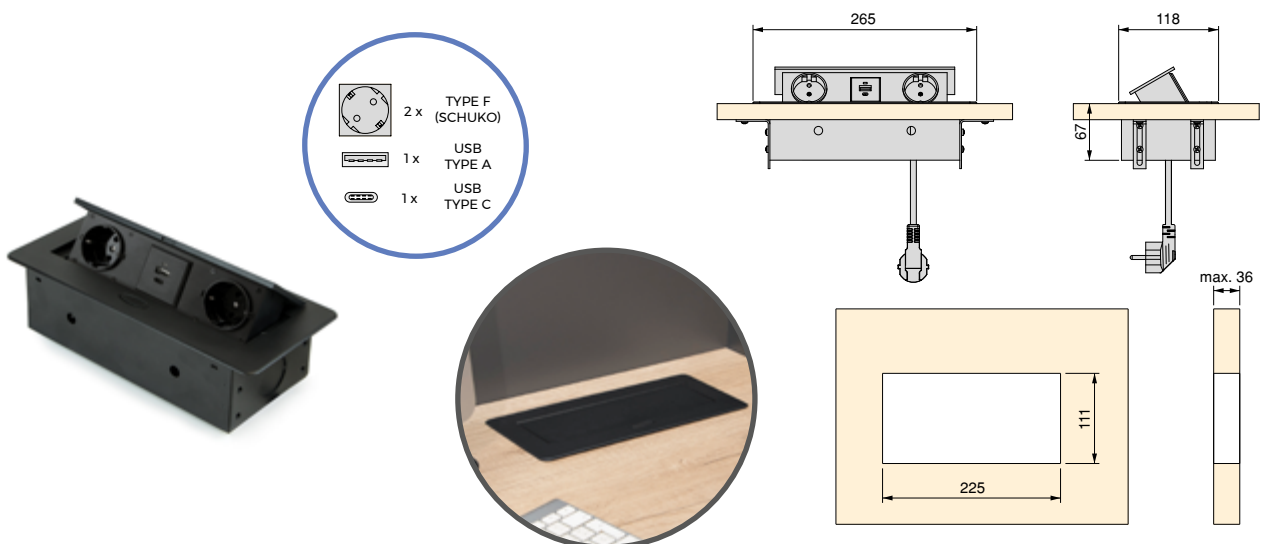



**Cable Profile
Przepusty Kablowe**



Circular cable organizer (Ø60mm, Ø80mm)

Kołowy organizator kabli (Ø60mm, Ø80mm)

A	B	Diametre/Srednica	Finishing/Wykończenie	Packaging/Opakowanie	Cod.
71	14	60	Black plastic/Czarny plastik 	100 Unit/Szt	5123817
95	20	80	Black plastic/Czarny plastik 	100 Unit/Szt	5123917

Plastic/Plastik

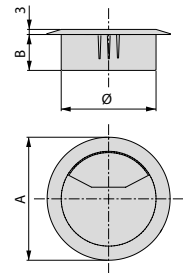
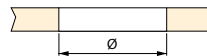

Plaswire 85 desk cable grommet (78x78mm)

Przepust kablowy stołowy Plaswire 85 (78x78mm)

Finishing/Wykończenie	Packaging/Opakowanie	Cod.
Black painted/Malowane na czarno 	15 Unit/Szt	5012514

Plastic/Plastik

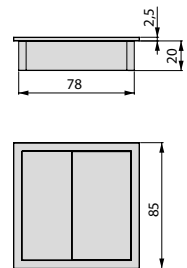
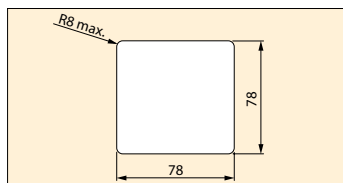

Plaswire 152 desk cable grommet (146x56mm)

Przepust kablowy stołowy Plaswire 152 (146x56mm)

Finishing/Wykończenie	Packaging/Opakowanie	Cod.
Black painted/Malowane na czarno 	10 Unit/Szt	5012614

Plastic/Plastik

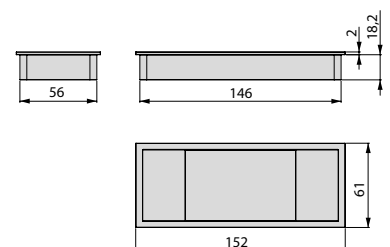
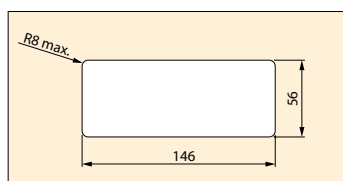

Hexa cable grommet column
Kręgosłupy kablowe Hexa

Finishing/Wykończenie	Packaging/Opakowanie	Cod.
Black plastic/Czarny plastik 	1 Unit/Szt	3025917

Plastic/Plastik

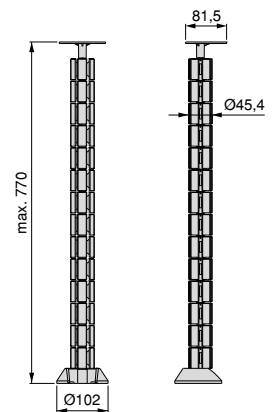

Ball bearing keyboard holder runners kit, Steel
Zestaw prowadnic kulkowych do klawiatury z regulacją wysokości, stal



Finishing/Wykończenie	Packaging/Opakowanie	Cod.
Black painted/Malowane na czarno 	20 Unit/Szt	4193409

Steel/Stal

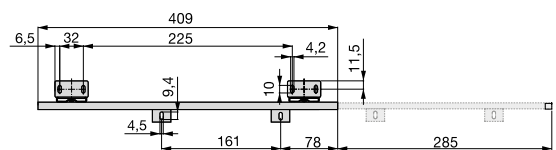
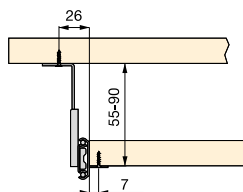

Tilting and rotating 360 ° desk monitor stands for table.
uchwyty na monitor na biurko, uchylne i obrotowe o 360 °.



Description/Opis	Finishing/Wykończenie	Packaging/Opakowanie	Cod.
Simple/Proste	Black painted/Malowane na czarno	1 Unit/Szt	3200014
Double/Podwójne	Black painted/Malowane na czarno	1 Unit/Szt	3200114

Steel/Stal

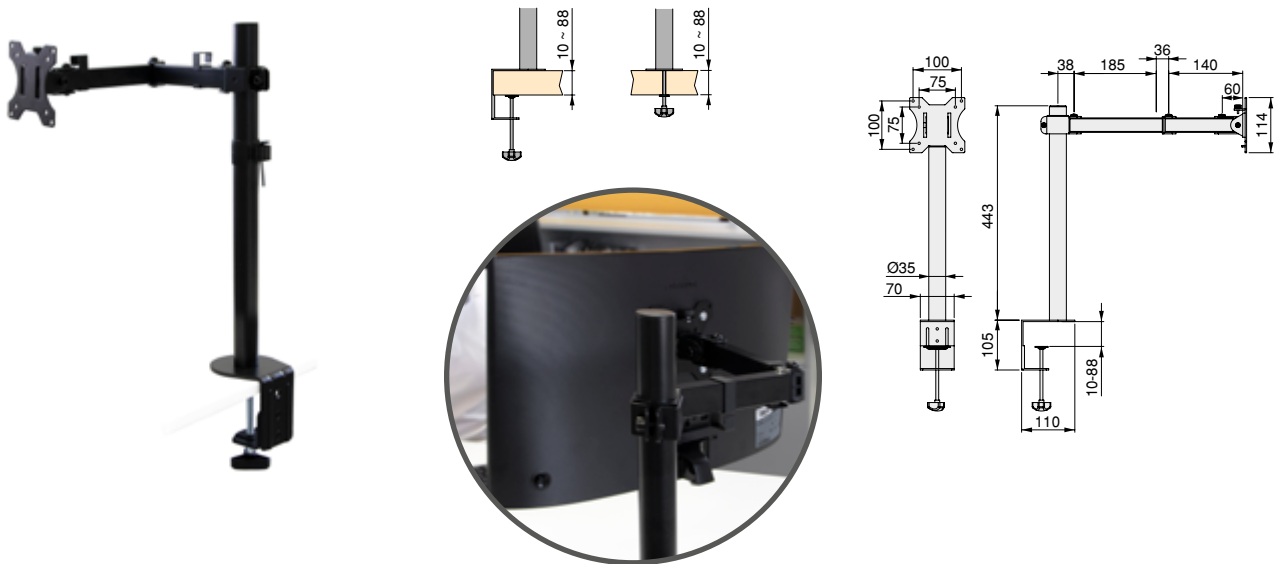

Giro1 Rotating base
Podstawa obrotowa Giro1



Finishing/Wykończenie	Packaging/Opakowanie	Cod.
Black painted/Malowane na czarno	20 Unit/Szt	4952614

Steel/Stal

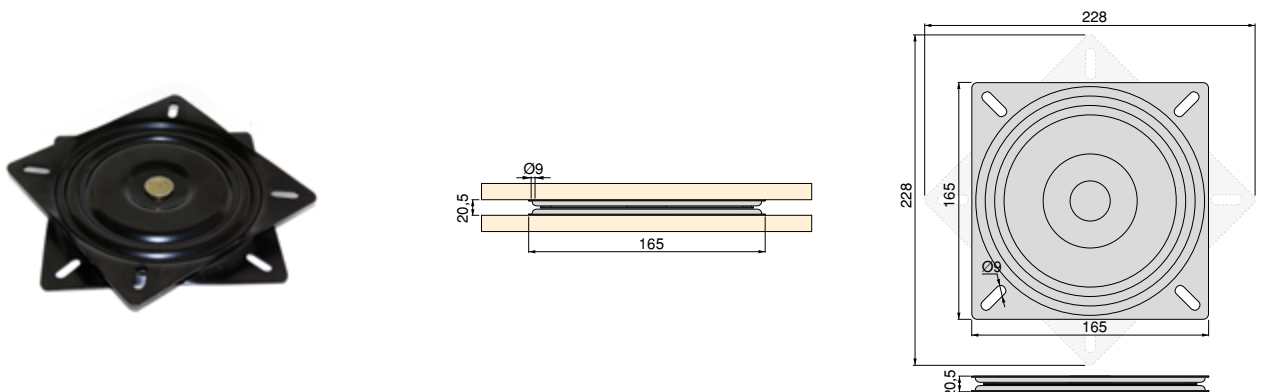

Modern handles
Nowoczesne uchwyty



Bremen furniture handle
Uchwyty meblowe Bremen



C	L	Finishing/Wykończenie	Packaging/Opakowanie	Cod.
96	128	Black anodized/Czarny anodowany	25 Unit/Szt	9355467
128	160	Black anodized/Czarny anodowany	25 Unit/Szt	9355567

Aluminium/Aluminium

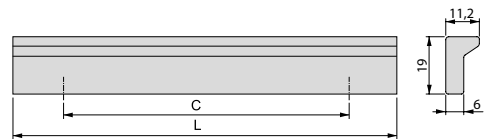

Setubal furniture handle
Uchwyty meblowe Setubal

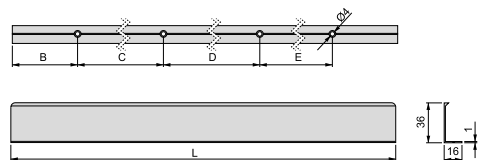

B	C	D	L	Finishing/Wykończenie	Packaging/Opakowanie	Cod.
35	128	-	198	Black anodized/Czarny anodowany	25 Unit/Szt	9300467

Aluminium/Aluminium



Osaka furniture handle
Uchwyt meblowy Osaka



C	L	Finishing/Wykończenie	Packaging/Opakowanie	Cod.
96	160	Dark grey/Ciemnoszary 	25 Unit/Szt	9359156
128	192	Dark grey/Ciemnoszary 	25 Unit/Szt	9359256
160	225	Dark grey/Ciemnoszary 	25 Unit/Szt	9359356



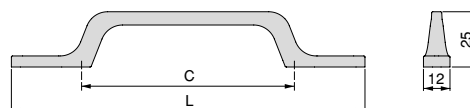

Aluminium/Aluminium



STEEL / STAL

Miami furniture handle
Uchwyty meblowe Miami



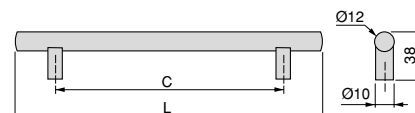

C	L	Finishing/Wykończenie	Packaging/Opakowanie	Cod.
128	188	Black painted/Malowane na czarno 	25 Unit/Szt	9357214
160	220	Black painted/Malowane na czarno 	25 Unit/Szt	9357314
192	272	Black painted/Malowane na czarno 	20 Unit/Szt	9357414
256	336	Black painted/Malowane na czarno 	20 Unit/Szt	9357514

Stainless steel/Stal nierdzewna



Zagreb furniture handle
Uchwyty meblowe Zagreb



C	L	Finishing/Wykończenie	Packaging/Opakowanie	Cod.
160	172	Black painted/Malowane na czarno 	20 Unit/Szt	9363614
224	236	Black painted/Malowane na czarno 	20 Unit/Szt	9363714

Zamak/Znal

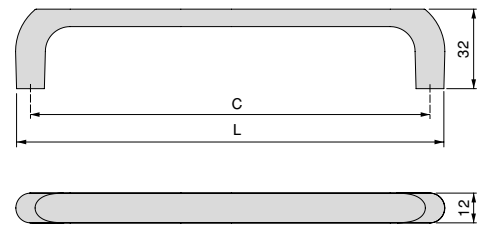

Baltimore furniture handle
Uchwyty meblowe Baltimore



C	L	Finishing/Wykończenie	Packaging/Opakowanie	Cod.
128	147	Titanium/Tytanowy	20 Unit/Szt	9359652
192	211	Titanium/Tytanowy	20 Unit/Szt	9359752

Zamak/Znal

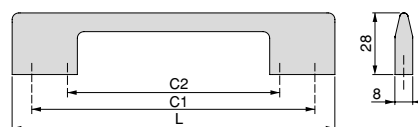

Varna furniture handle
Uchwyty meblowe Varna



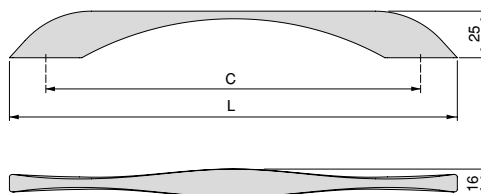

C	L	Finishing/Wykończenie	Packaging/Opakowanie	Cod.
160	181	Black painted/Malowane na czarno	20 Unit/Szt	9363414
224	247	Black painted/Malowane na czarno	20 Unit/Szt	9363514

Zamak/Znal



Kyoto Furniture handle
Uchwyty meblowe Kyoto



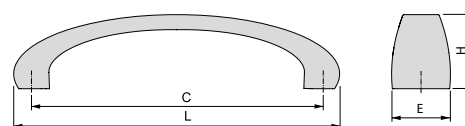

C	H	L	Finishing/Wykończenie	Packaging/Opakowanie	Cod.
128	25.5	142	Titanium/Tytanowy 	20 Unit/Szt	9355852
160	25.5	174	Titanium/Tytanowy 	20 Unit/Szt	9355952

Zamak/Znal



Kobe Furniture handle
Uchwyty meblowe Kobe



C	H	L	Finishing/Wykończenie	Packaging/Opakowanie	Cod.
128	29.2	164	Titanium/Tytanowy 	20 Unit/Szt	9356152
160	30.5	196	Titanium/Tytanowy 	20 Unit/Szt	9356252

Zamak/Znal

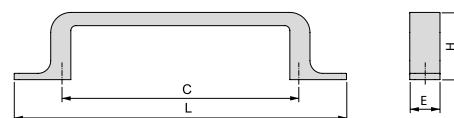

Memphis furniture handle
Uchwyty meblowe Memphis



C	L	Finishing/Wykończenie	Packaging/Opakowanie	Cod.
160	191	Titanium/Tytanowy 	20 Unit/Szt	9362752

Zamak/Znal

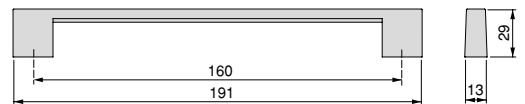

Cleveland furniture handle
Uchwyty meblowe Cleveland



C	L	Finishing/Wykończenie	Packaging/Opakowanie	Cod.
128	144	Black painted/Malowane na czarno 	25 Unit/Szt	9359414

Zamak/Znal

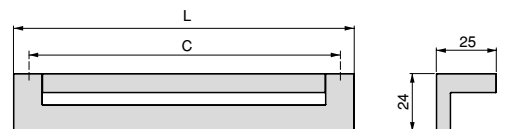

Stockholm furniture handle
Uchwyty meblowe Stockholm



C	L	Finishing/Wykończenie	Packaging/Opakowanie	Cod.
128	150	Black painted/Malowane na czarno	25 Unit/Szt	9006614

ABS/ABS

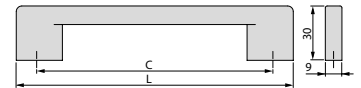

Assen furniture handle
Uchwyty meblowe Assen



C	L	Finishing/Wykończenie	Packaging/Opakowanie	Cod.
128	164	Black painted/Malowane na czarno	25 Unit/Szt	9006714
160	196	Black painted/Malowane na czarno	25 Unit/Szt	9006814

ABS/ABS

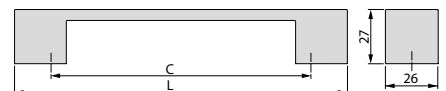

Halle furniture handle
Uchwyty meblowe Halle



C	L	Finishing/Wykończenie	Packaging/Opakowanie	Cod.
128	147	Black painted/Malowane na czarno	25 Unit/Szt	9008414

ABS/ABS



Vintage uchwyty
Vintage handles



Suez furniture handle
Uchwyty meblowe Suez



C	L	Finishing/Wykończenie	Packaging/Opakowanie	Cod.
160	184	Black painted/Malowane na czarno	20 Unit/Szt	9363214
224	248	Black painted/Malowane na czarno	20 Unit/Szt	9363314

Aluminium/Aluminium

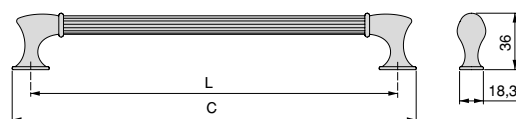

ZAMAK / ZAMAK

Budapest furniture knob
Gałka meblowa Budapest



Finishing/Wykończenie	Packaging/Opakowanie	Cod.
Black painted/Malowane na czarno	30 Unit/Szt	9362514

Zamak/Znak

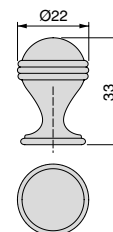

Mali Furniture knob
Gałka meblowa Mali



Finishing/Wykończenie	Packaging/Opakowanie	Cod.
Black painted/Malowane na czarno	25 Unit/Szt	9347014

Zamak/Znal

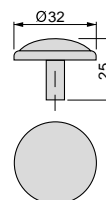

Marrakech furniture handle
Uchwyty meblowe Marrakech



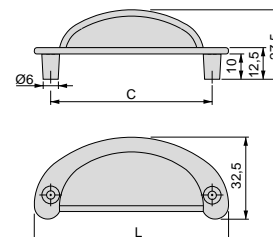

C	L	Finishing/Wykończenie	Packaging/Opakowanie	Cod.
64	77	Black painted/Malowane na czarno	20 Unit/Szt	9348914

Zamak/Znal



Bangkok furniture handle
Uchwyty meblowe Bangkok



C	L	Finishing/Wykończenie	Packaging/Opakowanie	Cod.
96	117	Satin titanium/Satynowy tytan 	20 Unit/Szt	9362357
160	182	Satin titanium/Satynowy tytan 	20 Unit/Szt	9362257

Zamak/Znal

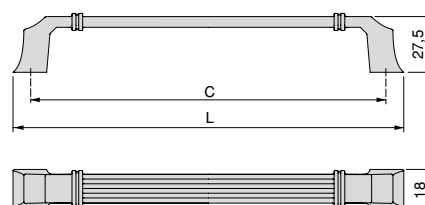

Baghdad furniture handle
Uchwyty meblowe Baghdad



C	L	Finishing/Wykończenie	Packaging/Opakowanie	Cod.
128	137	Black painted/Malowane na czarno 	20 Unit/Szt	9362014

Zamak/Znal

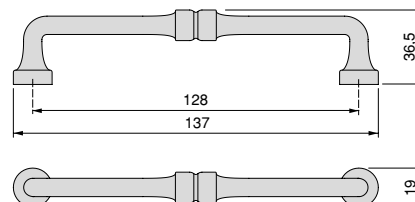

**Knobs
Gałek**



Istanbul furniture knob
Gałka meblowa Istanbul



C	Finishing/Wykończenie	Packaging/Opakowanie	Cod.
32	Black painted/Malowane na czarno	25 Unit/Szt	9362614

Zamak/Znal

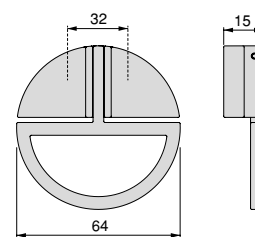

Baku furniture knob
Gałka meblowa Baku



Finishing/Wykończenie	Packaging/Opakowanie	Cod.
Black painted/Malowane na czarno	30 Unit/Szt	9362114

Zamak/Znal

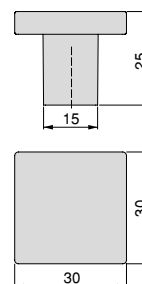

Panama furniture knob
Gałka meblowa Panama



Finishing/Wykończenie	Packaging/Opakowanie	Cod.
Black painted/Malowane na czarno	100 Unit/Szt	9291914

Zamak/Znal

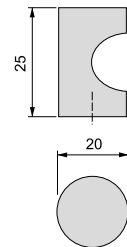

Varadero furniture knob
Gałka meblowa Varadero



Finishing/Wykończenie	Packaging/Opakowanie	Cod.
Titanium/Tytanowy 	20 Unit/Szt	9359552

Zamak/Znal

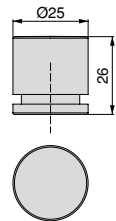

Bucharest furniture knob
Gałka meblowa Bucharest



Finishing/Wykończenie	Packaging/Opakowanie	Cod.
Black painted/Malowane na czarno 	30 Unit/Szt	9362414

Zamak/Znal

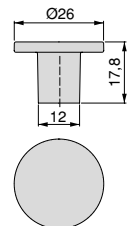

Square legs
Nogi kwadratowe



Square legs and table frame, 50x50mm
 Nogi kwadratowe i rama stołu, 50x50mm



900x500mm 7018612
 1.150x750mm 7018812



900x500mm 7018619
 1.150x750mm 7018819

Width/Szerokość	Finishing/Wykończenie	Packaging/Opakowanie	Cod.
750x750	Black painted/Malowane na czarno	1 KIT/Zestaw	2047114
1.150x750	Black painted/Malowane na czarno	1 KIT/Zestaw	2047214

Steel/Aço

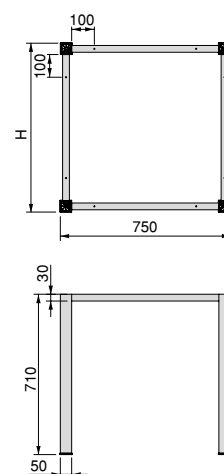

Square legs for table, 50x50mm
 Nogi stołowe kwadratowe, 50x50mm

Finishing/Wykończenie	Packaging/Opakowanie	N° pieces/Liczba elementów	Cod.
Black painted/Malowane na czarno	1 LOT/Partia	4 units/4 sztuk	2047014

Steel/Aço

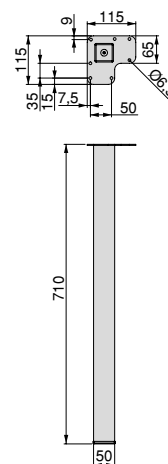

60 legs
Nogi 60



Table legs / Nogi stolowe
60 LEGS / NOGI 60

D. 60 mm Table legs in steel
Nogi stołu D. 60 mm ze stali

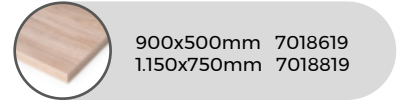
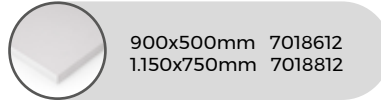

Diametre/Średnica	H	Finishing/Wykończenie	Packaging/Opakowanie	N° pieces/Liczba elementów	Cod.
60	870	Black painted/Malowane na czarno	1 Unit/Szt	1 unit/1 sztuka	3048014

Acero/Aço

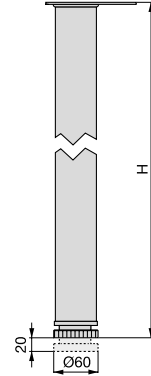
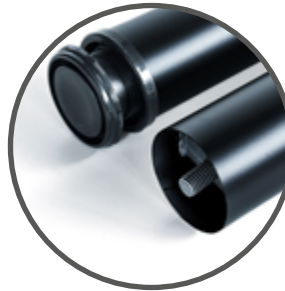

D. 60 mm Table legs in steel
Nogi stołu D. 60 mm ze stali



Diametre/Średnica	H	Finishing/Wykończenie	Packaging/Opakowanie	N° pieces/Liczba elementów	Cod.
60	710	Black painted/Malowane na czarno	1 LOT/Partia	4 units/4 sztuk	2034514

Acero/Aço

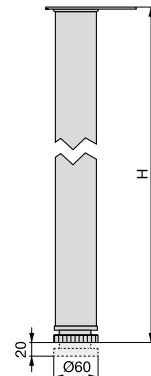
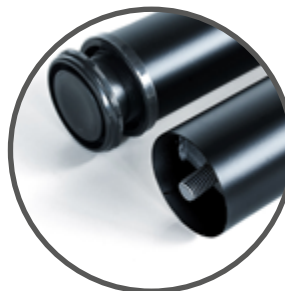

Table legs
Nogi stołowe



Cross legs for tables
Nóg stołowych Cross



900x500mm 7018612
1.150x750mm 7018812



900x500mm 7018619
1.150x750mm 7018819

Height/Wysokość	Width/Szerokość	Finishing/Wykończenie	Packaging/Opakowanie	Cod.
695	695	Black painted/Malowane na czarno	1 Pair/Kpl.	2040214

Steel/Stal

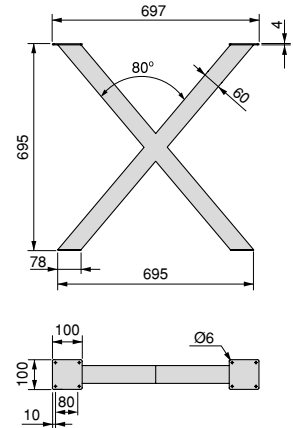

Rectangular Square legs for tables
Nóg stołowych prostokątnych Square



A	Height/Wysokość	Width/Szerokość	Finishing/Wykończenie	Packaging/Opakowanie	Cod.
600	720	600	Black painted/Malowane na czarno	1 Pair/Kpl.	2040014
800	720	800	Black painted/Malowane na czarno	1 Pair/Kpl.	2040114

Steel/Aço

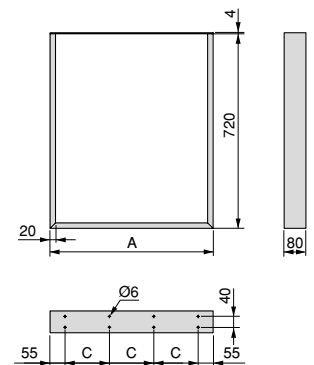
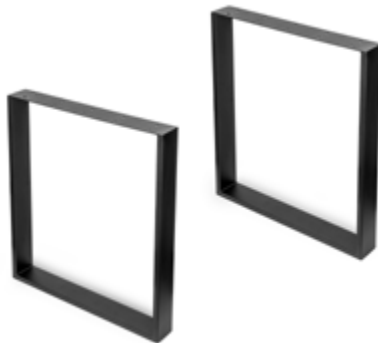

P3-rod Hairpin legs for tables
PNóg stołowych Hairpin z 3 prętów

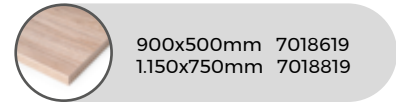
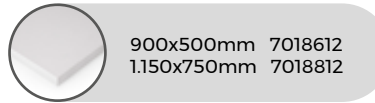

Height/Wysokość	Finishing/Wykończenie	Packaging/Opakowanie	N° pieces/Liczba elementów	Cod.
710	Black painted/Malowane na czarno	1 LOT/Partia	4 units/4 sztuk	2040414

Steel/Stal

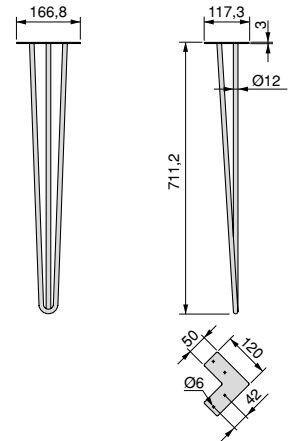

P2 rod Hairpin legs for tables
PNóg stołowych Hairpin z 2 prętów



Height/Wysokość	Finishing/Wykończenie	Packaging/Opakowanie	N° pieces/Liczba elementów	Cod.
400	Black painted/Malowane na czarno	1 LOT/Partia	4 units/4 sztuk	2040314

Steel/Stal

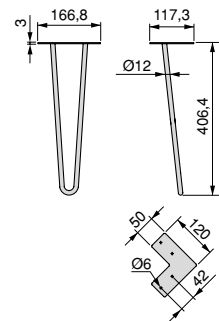

Set of lift-up mechanisms for coffee tables
Zestaw dwóch podnośników do stolików



Finishing/Wykończenie	Packaging/Opakowanie	Cod.
Black painted/Malowane na czarno	1 Pair/Kpl.	4014414

Steel/Stal

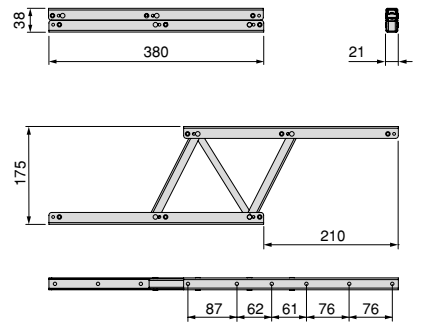

**Canapé bed
Kanapkowego**



Lift-up mechanism set for side canapé bed
Zestaw mechanizmu podnoszącego do bocznego łoża kanapkowego



Description/Opis	Finishing/Wykończenie	Packaging/Opakowanie	Cod.
90 cm/90 cm	Black painted/Malowane na czarno	1 Pair/Kpl.	7090114

Steel/Stal

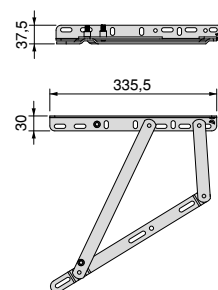

Lift-up mechanism set for front canapé bed
Zestaw mechanizmu podnoszącego dla przedniego łoża kanapkowego



Description/Opis	Finishing/Wykończenie	Packaging/Opakowanie	Cod.
135 cm/135 cm	Black painted/Malowane na czarno	1 Pair/Kpl.	7090214

Steel/Stal

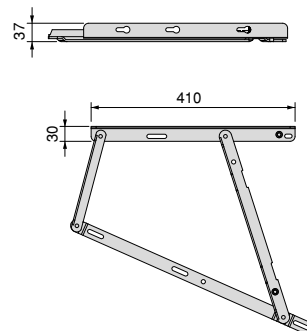

**Castors
Kółka**



Hole 2 castors kit with plate-mounted
Zestaw kółka Hole 2 z płytą montażową

Diametre/Średnica	Load/Ladunek	CxB	DxE	H	Finishing/Wykończenie	Packaging/Opakowanie	Cod.
60	30 Kg	42x42	32x32	92,5	Black painted/Malowane na czarno	1 KIT/Zestaw	2041414

Plastic, Steel/Plastik, Stal

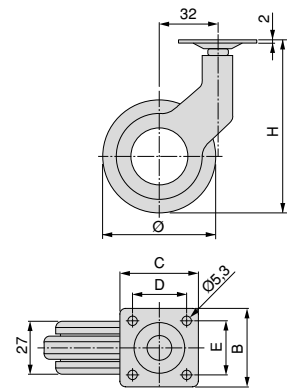

Hole castors kit with plate-mounted
Zestaw kółka Hole z płytą montażową

Diametre/Średnica	Load/Ladunek	CxB	DxE	H	Finishing/Wykończenie	Packaging/Opakowanie	Cod.
65	60 Kg	47x47	32x32	84	Black painted/Malowane na czarno	1 KIT/Zestaw	2041214

Plastic, Steel/Plastik, Stal

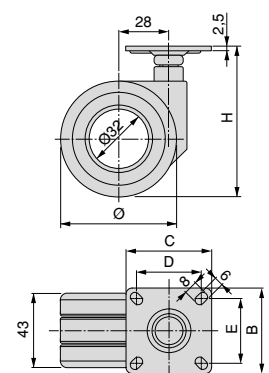

Black wheel kit with mounting plate

Zestaw czarnych kółek z płytą mocującą

Diametre/Średnica	Load/Ladunek	CxB	DxE	H	Z	Finishing/Wykończenie	Packaging/Opakowanie	Cod.
50	35 kg	50x50	35x35	75	6,5x5,5	Black plastic/ Czarny plastik	1 KIT/Zestaw	2008917
75	35 kg	65x65	45x45	100	6x9	Black plastic/ Czarny plastik	1 KIT/Zestaw	2009017

Plastic, Steel/Plastik, Stal

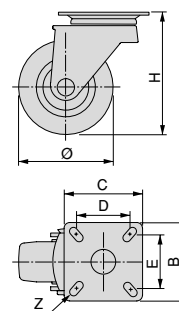

FUNCTIONAL CASTORS / FUNKCJONALNE KÓŁKA

Kit of castors for drawer units with plate

Zestaw kółek do szafek z płytą

Description/Opis	Diametre/Średnica	Load/Ladunek	CxB	DxE	H	Z	Finishing/Wykończenie	Packaging/Opakowanie	Cod.
4 without brake/4 bez hamulca	30	15 Kg	30x30	20x20	44	4,5	Black plastic/ Czarny plastik	1 KIT/Zestaw	2036817
2 with brake + 2 without brake/2 z hamulcem+ 2 bez hamulca	40	25 Kg	38x38	25x25	55	5,5	Black plastic/ Czarny plastik	1 KIT/Zestaw	2036717
2 with brake + 2 without brake/2 z hamulcem+ 2 bez hamulca	50	30 Kg	38x38	25x25	65	5,5	Black plastic/ Czarny plastik	1 KIT/Zestaw	2036617

Plastic, Steel/Plastik, Stal

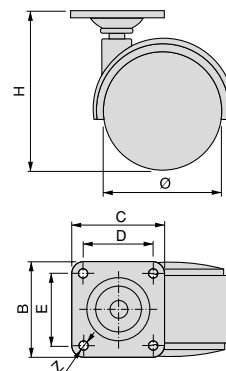

Kit of castors for drawer units with bolts

Zestaw zestawów kołowych do szafek z trzpieniem

Description/Opis	Diametre/Srednica	Load/Ladunek	A	H	Finishing/Wykończenie	Packaging/Opakowanie	Cod.
without brake/bez hamulca	40	25 Kg	38	50	Black plastic/ Czarny plastik	1 KIT/Zestaw	2037817

Plastic, Steel/Plastik, Stal

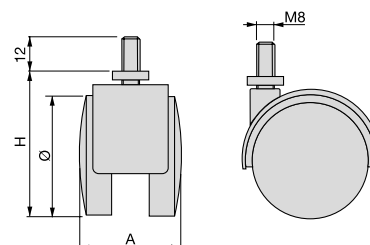

Castors for drawer units with plate

Kółka do szafek szufladowych z płytą

Description/Opis	Diametre/Srednica	Load/Ladunek	CxB	DxE	H	Z	Finishing/Wykończenie	Packaging/Opakowanie	Cod.
without brake/bez hamulca	30	15 Kg	30x30	20x20	44	4,5	Black plastic/ Czarny plastik	400 Unit/Szt	3036417
without brake/bez hamulca	40	25 Kg	38x38	25x25	55	5,5	Black plastic/ Czarny plastik	200 Unit/Szt	3036617
without brake/bez hamulca	45	25 Kg	38x38	25x25	59	5,5	Black plastic/ Czarny plastik	200 Unit/Szt	3036717
without brake/bez hamulca	50	30 Kg	38x38	25x25	65	5,5	Black plastic/ Czarny plastik	200 Unit/Szt	3036817
with brake/z hamulcem	40	25 Kg	38x38	25x25	55	5,5	Black plastic/ Czarny plastik	200 Unit/Szt	3037217
with brake/z hamulcem	50	30 Kg	38x38	25x25	65	5,5	Black plastic/ Czarny plastik	200 Unit/Szt	3037417

Plastic, Steel/Plastik, Stal

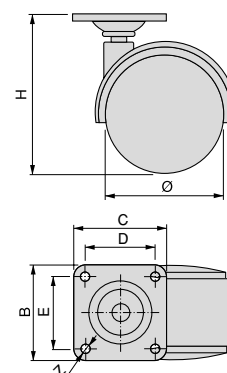

Drawer cabinet castors with bolt

Kółka do szafek szufladowych z trzpieniem

Description/Opis	Diametre/Średnica	Load/Ladunek	A	H	Finishing/Wykończenie	Packaging/Opakowanie	Cod.
without brake/bez hamulca	40	25 Kg	38	50	Black plastic/ Czarny plastik	 200 Unit/Szt	3037817

Plastic, Steel/Plastik, Stal

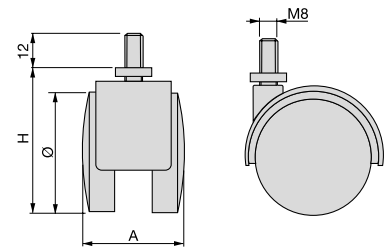

Drawer cabinet castors with nut

Kółka do szafek szufladowych z nakrętką

Description/Opis	Diametre/Średnica	Load/Ladunek	A	H	Finishing/Wykończenie	Packaging/Opakowanie	Cod.
without brake/bez hamulca	50	45 Kg	44	63	Black plastic/ Czarny plastik	 200 Unit/Szt	3035617

Plastic, Steel/Plastik, Stal

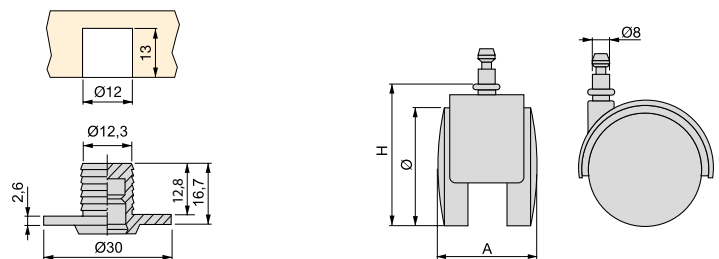

Furniture feet Smartfeet 1
Nóżki do mebli Smartfeet 1



H	Finishing/Wykończenie	Packaging/Opakowanie	Cod.
100 - 110	Black painted/Malowane na czarno	20 Unit/Szt	2006014

Plastic/Plástico

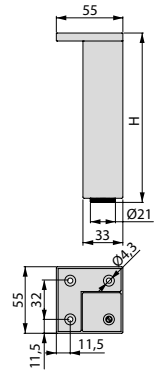

ADJUST INTERIOR AND EXTERIOR / REGULACJA WEWNĘTRZNA LUB ZEWNĘTRZNA

Circular leveler Ø48 for furniture
Regulator wysokości Ø48 do mebli



H	Finishing/Wykończenie	Packaging/Opakowanie	Cod.
17	Black plastic/Czarny plastik	400 Unit/Szt	2003817
27	Black plastic/Czarny plastik	200 Unit/Szt	8066817
45	Black plastic/Czarny plastik	200 Unit/Szt	8166817

Plastic, Steel/Plastik, Stal

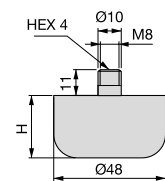
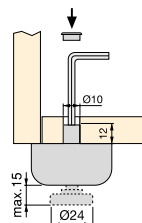



Emuca S.R.L

Via Messico, 80 • 35127 Padova (ITALIA)
T. +39 049 8702800 • F. +39 049 87 03019
www.emuca.it

Emuca Ltd.

75 Springfield Road • Chelmsford • Essex
CM2 6JG (UK)
T. +44 1268 530 674 • F. +44 1268 282 592
www.emuca.co.uk

Emuca S.A.

Pl. El Oliveral - c/H, 4 • Apartado de correos 176
46394 Riba-Roja del Túria • Valencia (ESPAÑA)
T. +34 96 166 70 19 • F. +34 96 166 71 82
www.emuca.es

Emuca S.A.R.L

Parc de l'Aubinière • 2 Avenue des Améthystes
44338 Nantes Cedex 03 (FRANCE)
T. +33 2 49 88 07 35 • F. +33 2 72 22 02 24
www.emuca.fr

Emuca Lda.

AV. da Liberdade n° 38, 4° • 1250-145 Lisboa (PORTUGAL)
T. +351 211 203 940 • F. +34 96 166 71 82
www.emuca.pt



CERTIQUALITY
È MEMBRO DELLA
FEDERAZIONE CISO

